

PJM Manual 3A:

Energy Management System (EMS) Model Updates
and Quality Assurance (QA)

Revision: 22

Effective Date: October 25, 2022

Prepared by
Operations Support Division

PJM © 2022



Table of Contents

Table of Exhibits..... 5

Approval..... 6

Current Revision..... 7

Introduction..... 8

 About PJM Manuals..... 8

 About This Manual..... 8

 Intended Audience..... 8

 References..... 8

 Using This Manual..... 10

 What You Will Find In This Manual..... 10

Section 1: General Requirements..... 11

 1.1 Overview..... 11

 1.2 Electrical Model Responsibilities for Generator Owner’s (GO’s) Operating Entity..... 12

 1.2.1 Electrical Model Responsibilities for Behind The Meter Generation (BTMG)..... 12

 1.3 Electrical Model Responsibilities for Transmission Owner’s Operating Entity..... 13

 1.4 Transmission Operating Guidelines and System Limits..... 13

 1.5 PJM’s Real-Time Reliability Model..... 14

 1.5.1 Maintaining the Steady-state Model 15

 1.6 Real-Time Telemetry Data Requirements for System Reliability..... 16

 1.7 PJM’s Operations Transient Stability Model..... 17

 1.7.1 Maintaining the TSA Model..... 17

Section 2: Model Information and Transmission Facility Requirements..... 18

 2.1 Overview..... 18

 2.2 Model Information and Data Requirements..... 19

 2.2.1 Internal World Modeling Philosophy (Layer 1)..... 21

 2.2.1.1 BES Facility Modeling..... 21

 2.2.1.2 Sub-transmission Modeling..... 21

 2.2.2 Sub-transmission Modeling Criterion and Responsibilities..... 22

 2.2.3 PJM External World Modeling (Layers 2 and 3)..... 24

 2.2.3.1 External World Modeling..... 24

 2.2.3.2 Model Exchange and Extraction 24

 2.2.3.3 Pseudo-Tie Modeling..... 25

2.2.3.4 Pseudo-Tie Eligibility.....	25
2.2.3.5 Pseudo-Tie EMS Modeling.....	25
2.2.4 Naming and Modeling Standards.....	25
2.2.5 Unique Device Considerations in the PJM Model.....	27
2.3 PJM Bulk Electric System (BES) Transmission Facilities.....	28
2.3.1 Prepare Initial BES Data to Denote BES Elements of the System.....	28
2.4 PJM Congestion Management Facilities.....	29
2.4.1 Telemetry Requirements for Facilities to be added to Congestion Management Control.....	30
2.4.2 Process to Change the PJM Congestion Management Control Facilities List.....	30
2.4.3 Process to Change Post Contingency Congestion Management Facilities....	32
Section 3: EMS Data Collection Process.....	34
3.1 Background on PJM EMS System Model Updates.....	34
3.2 PJM Transmission System Model Update/Data Collection Procedures.....	36
3.2.1 TO and PJM Staff Responsibilities.....	37
3.3 PJM Ratings Data (Thermal Equipment Ratings Monitor – TERM).....	45
3.4 Interim Update Capability.....	46
Section 4: EMS Model Change Control and Feedback.....	47
4.1 Overview of EMS Model Change Control and Feedback.....	47
4.2 Bus Connectivity and Engineering Data.....	49
4.3 Substation Nodal Connectivity.....	49
4.4 Processing Tie-Lines.....	51
4.5 Cut-ins and Contingencies.....	52
4.6 SCADA Mapping.....	55
4.7 One-line Life Cycle.....	56
4.8 Data Management Subcommittee (DMS).....	56
4.8.1 DMS SharePoint Website.....	57
Section 5: Real-time Application Support.....	58
5.1 Real-time Analysis.....	58
5.2 State Estimator (SE) Solution Quality and ICCP Links.....	59
5.3 Real-time Contingency Analysis (RTCA) and Solution Quality.....	60
5.3.1 RTCA Solution Quality.....	60
5.4 New EMS Models Validation and Benchmarking.....	61
5.5 Quality of Analysis Used in Real-Time Assessments.....	61
Appendix A: TERM Equipment Ratings Update Process.....	63
Appendix B: eDART Application Functionality Training (including Network Model and TERM Applications).....	72

Appendix C: Bulk Electric System (BES) Definition Implementation at PJM.....	73
Appendix D: Deleted.....	79
Appendix E: Checklist For New Equipment Energization Process.....	80
Appendix F: Acronyms & Descriptions.....	83
Appendix G: Examples of EMS Sub-transmission Modeling.....	86
Revision History.....	87

Table of Exhibits

Exhibit 1: PJM EMS Three (3) Layer Model.....	14
Exhibit 2: Transmission Facilities Page on PJM.com.....	29
Exhibit 3: Network Model Data Submission & Model Validation Timeline.....	40
Exhibit 4: PJM EMS Model Details.....	45
Exhibit 5: Sample Model Update Build Summary.....	47
Exhibit 6: One-Line Diagram Symbols.....	50
Exhibit 7: Tie Line Update Timeline.....	52
Exhibit 8: eDART Outage Ticket with Cut-in Flag.....	53
Exhibit 9: Dummy Switches to model new facilities pre- and post-construction.....	54
Exhibit 10: Sample Format for 6-Week Look Ahead Cut-in Report.....	55
Exhibit 11: TERM Ticket Submission Process.....	64
Exhibit 12: Examples of TERM Ticket Status Changes.....	65
Exhibit 13: Sample TERM Bulk Upload File.....	70
Exhibit 14: List of Monitored Priorities.....	76
Exhibit 15: Checklist for New Equipment Energization Process.....	80

Approval

Approval Date: 06/28/2022

Effective Date: 10/25/2022

Jeff Schmitt, Manager

Power Systems Modeling Department

Current Revision

Revision 22 (10/25/2022):

- Link to Tie-Line Information updated
- Model Management Department aligned to Power Systems Modeling
- Deterministic explanation for EMS solution
- Monitoring Priorities Clarifications
- .
-

Introduction

Welcome to the PJM Manual for Energy Management Systems (EMS) Model Updates and Quality Assurance. In this Introduction you will find information:

- What you can expect from the PJM Manuals (see “About PJM Manuals”).
- What you can expect from this PJM Manual (see “About This Manual”).
- How to use this manual (see “Using This Manual”).

About PJM Manuals

The PJM Manuals are the instructions, rules, procedures, and guidelines established by PJM for the operation, planning, and accounting requirements of the PJM and the PJM Energy Market. The manuals are grouped under the following categories:

- Transmission
- PJM Energy Market
- Generation and transmission interconnection
- Reserve
- Accounting and Billing
- PJM Administrative Services

For a complete list of all PJM Manuals, go to the Library section on PJM.com.

About This Manual

The PJM Manual for Energy Management System Model Updates and Quality Assurance is one of a series of manuals within the Transmission set. This manual focuses on specific process and procedures for the updating and verifying the PJM EMS model.

The PJM Manual for Energy Management System Model Updates and Quality Assurance consists of 7 sections. These sections are listed in the table of contents beginning on page 2.

Intended Audience

The intended audiences for the PJM Manual for Energy Management System Model Updates and Quality Assurance are:

- PJM dispatchers
- PJM operations staff
- Transmission Owners (TOs)
- PJM model / equipment owners

References

There are several reference documents that provide both background and detail. The PJM Manual for **Energy Management System Model Updates and Quality Assurance** does not

replace any of the information in these reference documents. These documents are the primary source for specific requirements and implementation details. The references to the PJM Manual for **Energy Management System Model Updates and Quality Assurance** are:

- [Transmission Owners \(TOs\) Agreement](#)
- Transmission Use Agreement
- Operating Representatives of Northeast Systems (ORNS) Terminal Operating Manual
- EMS User’s Manual
- PJM Manual for [Control Center and Data Exchange Manual \(M-01\)](#)
- PJM Manual for [Transmission Service Requests \(M-02\)](#)
- PJM Manual for [Transmission Operations \(M-03\)](#)
- PJM Manual for [Balancing Operations \(M-12\)](#)
- PJM Manual for [Emergency Operations \(M-13\)](#)
- PJM Manual for [Generator Operational Requirements \(M-14D\)](#)

The following table lists important links referenced throughout M-03A:

Subject	Link to Online Reference
PJM	www.pjm.com
PJM Manuals	http://www.pjm.com/library/manuals.aspx
PJM Calendar	http://www.pjm.com/Calendar.aspx
PJM Transmission Facilities	http://www.pjm.com/markets-and-operations/ops-analysis/transmission-facilities.aspx
PJM Open Access Same-Time Information System (OASIS) Informational website	http://www.pjm.com/markets-and-operations/etools/oasis.aspx
PJM Data Management Subcommittee (DMS)	http://www.pjm.com/committees-and-groups/subcommittees/dms.aspx
PJM Transmission Services Help	http://www.pjm.com/~media/markets-ops/trans-service/trans-fac-help.ashx
PJM DMS SharePoint website	https://connect.pjm.com
eDART Training Presentations	https://pjm.com/markets-and-operations/etools/edart.aspx

Using This Manual

We believe that explaining concepts is just as important as presenting procedures. This philosophy is reflected in the way we organize the material in this manual. We start each section with the “big picture.” Then we present details, procedures or references to procedures found in other PJM manuals.

What You Will Find In This Manual

- A table of contents that lists two levels of subheadings within each of the sections
- An approval page that lists the required approvals and a brief outline of the current revision
- Sections containing the specific guidelines, requirements, or procedures including PJM actions and PJM Member actions
- List of terms used in PJM Manual
- A section at the end detailing all previous revisions of this PJM Manual

Section 1: General Requirements

Welcome to the Requirements section of the **PJM Manual for EMS Model Updates and Quality**. In this section, you will find the following information:

- An overview of the general services provided by PJM (see “Overview”)
- Electrical Model Responsibilities for Generator Owner’s (GOs) Operating Entity
- Electrical Model Responsibilities for Transmission Owner’s (TOs) Operating Entity
- Transmission Operating Guidelines and System Limits
- A description of PJM’s Real-Time Reliability Model (see “PJM’s Real-Time Reliability Model”)
- An overview of Real-Time Telemetry data requirements for system reliability
- An overview of PJM’s Real Time transient stability

1.1 Overview

PJM is the regional Reliability Coordinator for the PJM RTO and is responsible for all regional reliability coordination as defined in the NERC Reliability Standards, along with the ReliabilityFirst and SERC Reliability Standards and applicable PJM Operating Manuals.

PJM operates the transmission grid in compliance with good utility practice, applicable standards, policies, guidelines and operating procedures, including, but not limited to:

- The PJM Transmission Operations Manual (M-03)
- North American Electric Reliability Council (NERC) Reliability Standards
- ReliabilityFirst Reliability Standards
- South Eastern Electric Reliability Council (SERC) Reliability Standards
- Individual Transmission Owners Operating Procedures submitted to PJM to identify specific operating problems that could affect operation of the interconnected PJM as references during normal and emergency operations of the PJM transmission grid.

In addition to facilities defined by the ReliabilityFirst and SERC definition of the Bulk Electric System (BES), PJM also includes all electric facilities defined as part of PJM’s Congestion Management (a/k/a Reliability & Markets) program, as well as other facilities as required to ensure reliable and economic operation. This comprehensive set of equipment is defined as the PJM BES and will be referenced as the PJM Bulk System in this document.

TOs shall operate the PJM Bulk System Facilities in accordance with the PJM Manuals and follow PJM instructions related to PJM responsibilities including, but not limited to:

- Performing the physical operation and maintenance of the PJM Bulk System Facilities
- Directing changes in the operation of transmission voltage control equipment
- Taking those additional actions required to prevent an imminent Emergency Condition or to restore the PJM transmission grid to a secure state in the event of a PJM system emergency

1.2 Electrical Model Responsibilities for Generator Owner's (GO's) Operating Entity

The PJM GO operating entities are responsible for providing engineering data such as:

- Impedances
- Ratings
- Generator step-up transformers
- Breakers/associated switches
- MW output and MVAR curves.

The GO is required to:

- Establish transmission facilities ratings and provide these ratings to PJM
- Provide local network integrity by defining operating limits, developing contingency plans and monitoring operations, if applicable
- Provide telemetry of generating units and transmission equipment to PJM and other TOs
- Provide real-time operations information to PJM and TOs
- Provide maintenance and construction plans to PJM and TOs
- Supply engineering data for generator and transmission system models to PJM and other TOs as required (subject to proper authorizations/Non-Disclosure Agreements (NDAs))
- Define contingencies to be evaluated in real time
- Submit outage requests to PJM according to PJM requirements, including:
 - o Auxiliary/station service or common service loads
 - o Generator step-up transformers for units above 20 MW and above which are connected to the BES system consistent with BES requirements outlined in Manual(s) 14B, 14D, 3, and 1

1.2.1 Electrical Model Responsibilities for Behind The Meter Generation (BTMG)

BTMG that is 10 MW or greater (or has been identified as requiring metering for operational security reasons) must have both revenue metering and telemetering for operational security purposes. See M14D, Appendix A: Behind the Meter Generation Business Rules, Transmission Owner BTMG Reporting and Communication Process for TO-related responsibilities for BTMG.

<http://pjm.com/committees-and-groups/subcommittees/dms.aspx><http://www.eia.gov/electricity/data/eia860/>

1.3 Electrical Model Responsibilities for Transmission Owner's Operating Entity

The PJM TO operating entity (or Local Control Center – LCC – Transmission Operator) responsibilities defined below are required to create and maintain an accurate model of the electric system. These models are required to analyze real-time conditions to help ensure that the PJM transmission system is operated safely and reliably.

PJM TOs are obligated to provide data and information to adequately model the electric system. In addition to the responsibilities identified in this manual, the PJM Consolidated Transmission Owner's Agreement (TOA) and the PJM manuals also reference models and information required by PJM. The roles identified by PJM are consistent with those in the NERC Functional Model for interconnected system operation. The responsibilities listed below, although not intended to be all-inclusive, identify many significant TO operational responsibilities and obligations which impact electric system modeling. The TO is required to:

- Establish transmission facilities ratings and provide these ratings to PJM
- Provide local network integrity by defining operating limits, developing contingency plans and monitoring operations if applicable
- Provide telemetry of transmission systems to PJM and other TOs
- Provide real-time operations information to PJM and other TOs
- Provide maintenance and construction plans to PJM and other TOs as required
- Supply engineering data for transmission system models to PJM and other TOs as required
- Define contingencies to be evaluated in real-time
- Submit outage requests to PJM according to PJM requirements

The TO representative assigned to the System Operations Subcommittee (SOS-T) is designated the 'owner' of EMS model information for their electrical system. Data Management Subcommittee (DMS) members and/or other representatives designated by the SOS-T member are points of contact for coordinating model data collection and/or model problem resolution.

Note that the data and information exchanged is subject to applicable code of conduct standards, and confidentiality requirements. For a more in-depth explanation of the topics mentioned above, please go to: <http://pjm.com/markets-and-operations/ops-analysis.aspx> under the section Training - Transmission Planning, Modeling & Energization.

1.4 Transmission Operating Guidelines and System Limits

PJM directs the operation of the PJM Bulk System Facilities in a manner to ensure the System Operating Limit (SOL) and Interconnected Reliability Operating Limit (IROL) remain within limit as indicated in Manuals M-03 and M-37. For details about PJM's thermal operation voltage requirements and SOL and IROL determination and monitoring refer to:

- Facility Ratings Definitions and Data Procedures – See M-03, Section 2 - Thermal Operating Guidelines.

- For Voltage Limit Definitions and Data Procedures – See M-03, Section 3 - Voltage and Stability Operating Guidelines.
- For SOL and IROL Limit Determination and Monitoring – See M-03, Section 3 - SOL and IROL Limits.

1.5 PJM’s Real-Time Reliability Model

PJM’s Real-Time Reliability Model, also known as the EMS model, is a computer representation of the power system facilities in the PJM RTO and other Control Areas that may impact the reliable operation of the PJM system. The model, maintained by designated PJM support staff, resides on the PJM EMS. The PJM EMS Transmission Network Application (TNA) programs utilize the model to:

- Calculate the real-time state of the electric system (using a State Estimator (SE)) and
- Assess if the PJM system is operating within relevant, established limits.

The EMS model is adapted for use in the real-time Locational Marginal Price calculator (LMP - see Section 5 of this manual, Data Interfaces). The LMP calculator is interfaced to another program, the Security Constrained Economic Dispatch (SCED) program which models PJM generators. The LMP and SCED programs work together to develop secure, economic operating points for the electric system and to provide Automatic Generation Control (AGC). These systems use data from various sources including, but not limited to, the EMS.

All the models are created and maintained from input data received by PJM from various sources including TOs, GOs, Load Serving Entities, and other Reliability Coordinators.

For real-time reliability analysis, PJM uses a multi-layer modeling approach:

PJM uses a “three concentric layer” model approach to manage and prioritize the amount of detail required to represent the electrical power system for PJM Operational needs, as shown below in Exhibit 1.

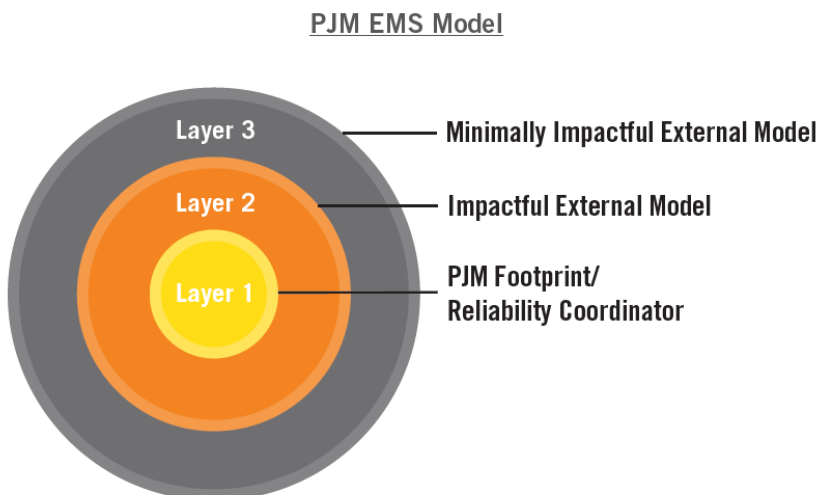

Exhibit 1: PJM EMS Three (3) Layer Model

Layer 1 is the PJM Footprint/Reliability Coordinator layer, which has explicit modeling with all available telemetry for BES facilities (and some non-BES facilities) to reliably operate the PJM footprint. This data is obtained from the TOs and GOs to ensure that PJM has an accurate model for its internal footprint.

Layer 2 is the Impactful External Model layer, which includes impactful neighboring areas external to the PJM footprint that are impacted by Joint Operating Agreements (JOA) signed between other entities and PJM. Layer 2 facilities are modeled in sufficient detail using all available telemetry to support an accurate PJM internal solution, proper market-to-market coordination, and proper Pseudo-Tie dispatching. This level is modeled at nearly the same detail as the internal PJM footprint. Modeling data for these external areas is exchanged with our neighboring ISOs as well as some neighboring TOs to ensure the PJM model is up to date and accurate. Sub-transmission modeling is considered for Layer 2 facilities as a result of JOAs on a case-by-case basis.

Layer 3 is the Minimally Impactful External Model layer, which includes external entities and facilities that have little to no reliability impact on the PJM footprint and are not impacted by JOAs. Facilities included in this portion are modeled with little to no telemetry and are mostly focused on generators and higher voltage areas. PJM does not model sub-transmission facilities for the Layer 3 model.

There are two methods used to represent Layer 3 areas:

1. In certain instances, the model is observable up to the Layer 2 external model boundary level, and, for the buses directly outside of that Layer 2 boundary demarcation, the model is cut with an equivalized load or generator to represent the outside system from that point. Telemetry is utilized in those instances to ensure that the outside model solves properly.
2. Model outside Layer 2 allows for solution quality mismatch to occur outside of the Layer 1 and Layer 2 model areas, which are of importance to PJM.

1.5.1 Maintaining the Steady-state Model

The models are only as accurate as the input data used to derive them; therefore, timely and accurate data updates are critical. These updates are performed on a regularly scheduled basis every year. Summer, Fall, Winter, and Spring Builds are normally performed. The data close dates for each build are posted and can be viewed by browsing this web page: <http://www.pjm.com/committees-and-groups/subcommittees/dms.aspx> and selecting 'System Changes' from the drop-down menu. The entire schedule may also be viewed or downloaded in PDF format [here](#). In the build schedule document, you will find three columns labeled as follows: Build, Data Close, and Scheduled PRD Production Date. The Data Close column specifies the date by when a TO shall have all data submitted to PJM. The Scheduled Production Date refers to when PJM will be placing the new build onto their production environment. PJM relies upon TOs and GOs along with data obtained through JOAs to keep models current. It is important to note that GO information is primarily obtained from either the PJM planning queues or from PJM Interconnection Coordination staff members.

The NERC Multi-Area Modeling Working Group (MMWG) modeling effort provides basic electrical models of the Eastern Interconnection which PJM uses for regional and seasonal studies, as well as Available Transfer Capability (ATC) calculations. This information is not sufficient for real-time applications since MMWG cases use a bus/branch approach. Additional

details are needed to support real-time evaluations (e.g., breaker and/or switch status, tap positions, etc.). Real-Time models also differ from MMWG models in that State Estimation requires branch flow, breaker status, and voltage telemetry information which is generally available through Inter-Control Center Communication Protocol (ICCP) or similar data links. Note that PJM does use MMWG data such as line impedances and basic connectivity information when necessary, especially for external system models.

Other practical considerations regarding the real-time models involve throughput and solution integrity. These qualities tend to degrade as the scope of the model grows, so balancing the competing requirements is essential. It is incumbent upon PJM staff to balance the ability of the software to produce timely and reliable results with the appropriate amount of electrical detail. Consequently, PJM reserves the right to determine what level of model detail is appropriate and adequate for ALL portions of the model.

1.6 Real-Time Telemetry Data Requirements for System Reliability

PJM Manual M-01, the PJM Manual for Control Center Requirements, shall be used as the source for Control Center requirements. This includes, but is not necessarily limited to, metering placement requirements, data acquisition frequency, and accuracy requirements. Technical requirements apply to both PJM TOP facilities and facilities outside the PJM TOP area.

In general, Analog Data measurements are required for:

- Voltages for buses at 69 kV and above
- MW and MVAR values for all generating units greater than 1 MW. See M14D for specific generation requirements.
- MW and MVAR values for designated transmission facilities (lines, transformers, phase angle regulators, series devices) at 69 kV and above (if single-phase metering is employed, the B-phase is preferred)
- Transformer phase angle regulator (PAR) tap positions for modeled and controlled transformers
- Transformer load tap changer (LTC or TCUL) tap positions for modeled and controlled transformers
- MVAR values for synchronous condensers and static VAR compensators
- MW and MVAR injections on buses at 69 kV and above
- Selected station frequencies

In general, Status Data is required for:

- Circuit breaker and disconnect status for each modeled facility at 69 kV and above

See Manual 1, Section 3.8 for specifics on coordination efforts of ICCP planned outages and time periods that are not allowed.

Note:

Telemetry information must be received by PJM no later than two (2) weeks prior to the scheduled cut-in.

PJM members with an ICCP connection to the PJM EMS shall provide a full SCADA file in addition to an ICCP data dump to PJM at least every 6 months, or upon PJM's request.

1.7 PJM's Operations Transient Stability Model

PJM's Transient Stability Assessment (TSA) is a separate tool, largely independent of the EMS Network Analysis tools and data, leveraged in the Operations Planning, Same-day Operations, and Real-time Operations time horizons. TSA utilizes the Real-time Reliability Model (a/k/a EMS model) to establish positive-sequence electrical connectivity and uses the SE/PF solution to establish the initial conditions prior to performing transient analysis simulations. To simulate transient behavior, data from PJM planning models is interfaced to the EMS model to establish appropriate generator, governor and exciter models, as well as fault clearing times associated with protection schemes for the contingencies to be studied.

1.7.1 Maintaining the TSA Model

Timely and accurate data updates (e.g., impedances, dynamics, and fault clearing times) are critical to ensure the quality of the simulation results. Models and associated data are updated periodically via the EMS Model Information and Transmission Facility Requirements section of this manual or via MOD-032 requirements. In addition, TOs are required to provide updates as needed. PJM may also request data checks or verification from TOs or GOs on an ad hoc basis. Refer to PJM M-03: Transmission Operations, Section 3.9 on the uses of TSA in Operations.

Section 2: Model Information and Transmission Facility Requirements

Welcome to the Model Information and Transmission Facility Requirements section of the **PJM Manual for EMS Model Updates and Quality Assurance**. In this section, you will find information on the following topics:

- Overview of Model Information and Data Requirements
- PJM's Internal World Modeling Philosophy
- Sub-transmission Modeling Criterion and Responsibilities
- PJM's External World Modeling
- Unique Device Considerations in the PJM Model
- PJM Bulk Electric System (BES) Transmission Facilities

2.1 Overview

As discussed in Section 1: General Requirements, PJM's Real-Time Reliability Model is constructed of three (3) layers with varying levels of details. The first layer consists of the electrical systems within the PJM footprint; the second layer consists of adjacent systems; and the third layer consists of systems which are judged to have minimal electrical impact on PJM.

Modeling requirements for electrical simulations depend upon the circumstances and how the results will be applied. It is important to note that the electric system is managed through a coordinated effort among several different interests. Note that RTOs such as PJM are responsible for a wide-area-view (WAV) of the BES while Transmission and/or Distribution System Owners are responsible for local area problems. In all cases, the physics of the electrical grid must be modeled to produce accurate results of actual and expected flows.

PJM's role is to identify and prevent problems which may impact interconnected systems. Consequently, PJM models must encompass transmission systems belonging to members of the organization, as well as models of adjacent transmission systems since these systems may also impact internal flows and voltages. Within the PJM footprint, PJM operators manage the system by controlling capacitors, reactors, load-tap-changing transformers, phase shifters, Static VAR Compensators (SVCs), and generation patterns to eliminate actual and potential problems. PJM works with non-PJM companies to coordinate management of the overall electrical grid in the eastern portion of North America. PJM works with outside organizations to maintain and build models as required. This usually occurs as the result of regularly scheduled information exchange with the outside entities.

To establish the facilities which PJM will manage using all available means, including off-cost generation, a Tariff Facilities List is maintained and posted to the PJM website: <http://www.pjm.com/markets-and-operations/ops-analysis/transmission-facilities.aspx>. The list indicates PJM EMS modeling, Tariff obligations, and TO Outage Reporting responsibilities. This section describes the attributes of this facility list and how TOs can apply for amendments to the list.

Section 2 of M-03A concentrates on describing modeling requirements for Layer 1, the PJM footprint. It includes descriptions of real-time model attributes and telemetry requirements used by PJM's security analysis programs. Similar requirements apply to portions of Layer 2 of the model which involves adjacent electric system. Note that data exchange to support Layer 2 real-time models usually occurs directly with the adjacent RTOs/Independent System Operators (ISOs), not TOs. PJM TOs will usually be involved only if their facilities are impacted.

2.2 Model Information and Data Requirements

TOs and GOs are responsible for providing the information and data needed by PJM to accurately model their electrical system. PJM models have multiple data attributes, including modeling the physical devices, appropriate limits, substation and network connectivity, telemetry to support State Estimation (SE), SA, etc. The data and information to be submitted to PJM Power Systems Modeling Department includes, but is not limited to, the following:

- Substation topology (including generator substations), facility connectivity, and physical location upon request (State and Global Positioning Satellites (GPS) coordinates)
- Equipment names or designations
- Facility physical characteristics including impedances, transformer taps, transformer tap range, transformer nominal voltages, etc.
- Facility limits and ratings
- Voltage control information and recommended set-points
- Recommended contingencies to be studied
- Protective device clearing times, as appropriate, to support Real-Time transient stability analysis
- Buses, breakers, switches, and injections or shunts such as Loads, Capacitors, SVCs, etc.
- Lines and series devices (reactors or series capacitors)
- Transformers and phase shifters
- Generator auxiliary, station service, or common service loads (MW & MVAR)
- Generator step-ups to be modeled for BES generators
- Generator 'D' curve limits
- Real-Time analog and equipment status telemetry for transmission elements, including, but not limited to:
 - o Breaker, switch, or other equipment status required to determine connectivity
 - o Real (MW) and reactive (MVAR) power flow for lines, transformers (high or low-side), phase shifters
 - o Real (MW) and reactive (MVAR) for loads and/or other injections as appropriate
 - o Reactive (MVAR) power flow for caps, SVCs

- For dead band SVCs that allows for the SVC to not operate in a specified voltage range (dead band), the following data is required for submission in the Network Model ticket:
 - o Additional modeling parameters are needed for this enhanced capability:
 - Node to be controlled
 - Dead band Minimum Voltage
 - Dead band Maximum Voltage
 - SVC maximum MVAR capability (Boost)
 - SVC minimum MVAR capability (Buck)
 - Minimum time for gathering modeling data for SVCs with this capability is a six month advanced data submission
 - o Tap position (fixed and variable) for transformers, phase shifters, and variable shunt devices
 - o Reportable, non-telemetered facility and equipment status
 - o Real-Time analog and equipment status telemetry for generation, including, but not limited to:
 - Breaker, switch or other equipment status required to determine connectivity
 - Real power flow (MW) Specify if net or gross
 - Reactive power flow (MVAR) Specify if net or gross
 - Voltage (kV)
 - Plant auxiliary, station service, or common service load (MW & MVAR)
- Reportable, non-telemetered facility and equipment status.

Flow Devices

A flow device in the PJM EMS model is a representation of a flow disrupting element (i.e., circuit breaker, disconnect, air break, or similar elements) that has been set up to calculate a SE flow across it and thermal ratings are also applied to that flow device, similar to a line or transformer. Monitoring of a Flow Device is only performed if the flow across is deterministic. For example, breakers in a closed in ring bus are not monitored since the flow is not deterministic. The flow device must be able to calculate net if gross output is available, or calculate gross output if net is available.

To change an existing PJM-modeled element to a flow device, TOs must submit a Network Model ticket via <https://esuite.pjm.com/mui/> as part of the Model Build process. The ticket must clearly state if an element is being changed to a flow device, or if it is a brand new flow device. TOs must then provide equipment ratings via the TERM application through a similar process to line and transformer ratings updates.

Note:

Also see Manual 1, Control Center and Data Exchange Requirements.

Refer to Appendix E: Checklist for New Equipment Energization Process for a high level guideline of PJM requirements throughout the baseline/supplemental transmission upgrade process.

2.2.1 Internal World Modeling Philosophy (Layer 1)

2.2.1.1 BES Facility Modeling

PJM modeling guidelines and principles are designed to support the NERC Bulk Electric System (BES) definition on Facilities above 100 kV. PJM considers the Internal World Modeling as “Layer 1” modeling, which explicitly includes BES facilities with all available telemetry to reliably operate the PJM footprint. This telemetry and model data is obtained from the TOs and GOs to ensure that PJM has an accurate model for its internal footprint.

Modeling decisions are subject to PJM Power Systems Modeling Department (PSM) staff approval based on known criteria, historic decision trends, and future considerations.

2.2.1.2 Sub-transmission Modeling

To ensure that the PJM system is operated reliably and economically, some facilities rated below 100 kV may need to be modeled. PJM modeling guidelines and principles are designed to support the NERC Bulk Electric System (BES) definition and the associated corollary recommendations on facilities under 100 kV. This section clarifies PJM policy for including less than 100 kV sub-transmission facilities in the EMS model.

As part of PJM’s model update process (annual RTEP and quarterly EMS), TOs are responsible for nominating facilities to be modeled in the PJM EMS, including sub-transmission facilities. PJM staff members work with TO representatives to model sub-transmission facilities appropriately, subject to PJM approval.

Sub-transmission facilities can impact the BES, especially when outages are necessary. In some cases, sub-transmission is used to provide an alternate network path to higher voltage station facilities. In other cases, switching on underlying systems serves to re-allocate load centers. For any sub-transmission facility modeling, a similar set of requirements is needed as has been employed for all BES facilities.

PJM modeling of sub-transmission shall be managed and maintained consistent with all other elements of the system model. Expanding the model needs a clearly identified benefit, typically based on operational experience, to warrant the addition of more detailed model (Ex. Enhancing SE and/or CA solution accuracy).

PJM applies engineering judgment to reduce the model where possible. This maintains accurate topology and associated flow and voltage measurements, ensuring a robust model and SE solution. In addition, since increasing the size of the model can lead toward lengthening the time to solve each of the simulations. PJM staff members will model BES facilities and apply engineering judgment to model the non-BES facilities appropriately.¹

¹ See TOP-001-4 R10, 10.3 and 10.6, https://www.nerc.com/_layouts/15/PrintStandard.aspx?standardnumber=TOP-001-4&title=Transmission%20Operations&jurisdiction=United%20States

2.2.2 Sub-transmission Modeling Criterion and Responsibilities

Modeling decisions are subject to PJM Power Systems Modeling Department (PSM) staff approval based on known criteria, historic decision trends, and future direction considerations. Considerations for all sub-transmission modeling include:

- Does the facility impact a BES facility or is it requested to be a BES facility? (Appropriate telemetry shall be available.)
- Do the proposed non-BES facilities have the same level of available telemetry as BES facility requirements?
- Are the proposed equipment facilities under 100 kV?
- Are the contingency analysis results in the area impacted by this facility?

PJM staff members apply engineering judgment to model the non-BES facilities appropriately. These engineering judgments, cited in this manual, include, but are not limited to:

- Transmission constraints
- Parallel circuitry
- Tightly coupled facility
- Solution throughput and integrity
- Appropriate amount of detail
- Facility observability
- Congestion management (including post)
- Tie lines
- AGC
- Day-ahead Markets
- RTEP-related projects
- BES reliability and economics
- Coordination with TO model
- Electrical closeness
- Impact on State Estimator (SE) solution
- Operating experience
- Best analysis to operators for reliability and commercial evaluations
- Monitored Priority status
- TO ability to validate model
- Settlements impact
- Additional metering to enhance error detection

Sub-transmission Modeling Considerations for TOs:

- TOs shall evaluate contingencies used by PJM to simulate outages to determine if load re-allocations are a better alternative. To redistribute loads, TOs shall provide information to PJM regarding the appropriate simulation of the re-allocated load(s) (i.e., percentages of the distribution and location).
- TOs shall coordinate with PJM staff on an ongoing basis to identify modeling updates to be applied in the PJM EMS to ensure that models are appropriate when simulating outage conditions.
- Representatives for each TO shall provide justification and analysis of all requested sub-transmission facilities and coordinate modifications with PJM MMD staff.
 - o If facilities under 100 kV are ‘networked,’ providing alternate flow paths to higher voltage equipment, TOs are to provide modeling details and justification to PJM for joint assessment to determine if the system should be in the PJM EMS model.
- TO shall provide appropriate status and loading information (Digital and Analog Telemetry) – for proper SE solutions.
- TOs should identify SA contingency simulations impacted by automatic load transfer schemes and work with PJM representatives to reallocate load if appropriate using recently developed features of the PJM EMS.

Sub-transmission Modeling Considerations for PJM:

- Data requirements for EMS models shall adhere to the specifications in this Manual.
 - o PJM staff shall facilitate discussions at the Data Management Subcommittee (DMS) meetings to clarify and explain the sub-transmission modeling practices. The sub-transmission data submission shall include justification for inclusion in the EMS model and indicate if the facilities are to be considered BES elements.²
 - o The cited examples of sub-transmission facility modeling are typically driven by actual operational experience and engineering assessment/experience.
 - o The need to expand the model, particularly to incorporate sub-transmission elements, can be identified through the PJM outage assessment process (see Attachment B in PJM Manual 38: Operations Planning).
 - o If PJM staff initiates a model request, coordination with the TO staff shall:
 - Allow for PJM to receive complete, timely, and clear modeling data
 - Allow for PJM to model BES facilities and apply engineering judgment to model the non-BES facilities appropriately
 - Allow for PJM to review and address any non-BES nominated sub-transmission facility additions to the PJM EMS model on a case-by-case basis following the procedure documented in PJM Manuals
 - Allow for PJM models to be kept intentionally to the minimum size possible to achieve acceptable solution results (SE & CA)

² Refer to **Compliance Bulletin 14: Definition of Bulk Electric System (BES) – PJM Member Requirements** at <https://pjm.com/-/media/library/whitepapers/compliance/cb014-bulk-electric-system-definition-pjm-member-requirements.ashx?la=en>

- Ensure that all concerned have a common and full understanding of any modeling changes required

2.2.3 PJM External World Modeling (Layers 2 and 3)

2.2.3.1 External World Modeling

Referring back to Exhibit 1, External World Modeling refers to “Layers 2 and 3” in the Overall PJM Modeling Philosophy. External world modeling is necessary to allow units to be properly dispatched through Pseudo-Ties, provide proper market-to-market (M2M) coordination, and to properly operate the PJM internal system reliably.

Explanation of Consideration for External Modeling in the PJM EMS Model

PJM staff members are responsible for regularly exchanging model data with other organizations of the various PJM JOAs and NDAs. Through the data exchange process, model updates will be assessed and incorporated into the PJM models as required. Generally, Real-Time data is interfaced to the PJM models for areas of particular interest/concern (see Layer 2 in Exhibit 1, PJM EMS Three (3) Layer Model). These portions of the external electrical models are modeled in detail with supporting real-time status and analog data obtained from other RTOs, plus adjacent TOs. As one would expect (and following the physics of the interconnected systems), the areas of interest tend to be along Extra High Voltage (EHV) and high-voltage paths extending from PJM into adjacent systems. These electrically close areas are then state estimated, along with the rest of the PJM interconnected footprint.

Where possible, models take advantage of available telemetry such as at generators, high voltage facilities, and tie lines in the outside systems. Using engineering judgment and operating experience, these boundaries are extended as required and systems that are electrically remote will typically be cut minimizing any equivalence (Parameterization scheme philosophy). PJM has agreements with adjacent systems to exchange model data on a regular basis. PJM staff members involved with model support review the model changes received from outside entities. If model details are needed, PJM staff will establish dialogue with the outside entities in order to maintain an accurate representation of the outside systems. Data exchanges have been accomplished in several different formats to date (e.g., CIM, PSSE, SERC), and the process continues to evolve.

2.2.3.2 Model Exchange and Extraction

PJM modeling staff members are responsible for exchanging modeling data with external entities as parts of various Joint Operating Agreements (JOAs), Joint Reliability Coordination Agreements (JRCA), and Non-Disclosure Agreements (NDAs). There are multiple types of file and format exchanges in which PJM participates. When possible, PJM exchanges Common Information Model (CIM) models with neighboring entities. This is the preferred format for exchange.

With the CIM, PJM can compare a previous CIM model for a company with the latest submission and export the changes between those versions. This allows PJM to evaluate all of those changes and determine which are necessary to be performed in the PJM EMS model.

PJM also does a “SERC style” exchange with neighboring ISOs. The SERC style exchange is an exchange of multiple equipment parameter dumps, such as line impedances, shunt nominal values, transformer parameters, etc. This exchange similarly allows PJM to verify the parameters currently in their EMS as well as reference anything new that has been added.

PJM also participates in multiple monthly meetings that are either held via teleconference and/or WebEx or in person with neighboring RTOs to discuss each entities' major projects, tie-line changes, and general updates. This allows a forum for other entities to ask questions that are needed to properly implement the changes discussed.

2.2.3.3 Pseudo-Tie Modeling

Please refer to Manual 12, Attachment F: Dynamic Transfers, for processes and procedures associated with Pseudo-Ties. Dynamic Transfers have two categories for submission: dynamic schedules and Pseudo-Ties. The EMS model is only impacted by Pseudo-Ties, as dynamic schedules require no EMS modeling changes.

2.2.3.4 Pseudo-Tie Eligibility

In order to determine if a Pseudo-Tie is eligible to be implemented into the PJM system, it must pass the following three tests:

- Electrical Distance Test
- M2M Flowgate Test
- Planning Criteria Test

Please refer to Manual 12, Attachment F: Dynamic Transfers for more information about each test.

2.2.3.5 Pseudo-Tie EMS Modeling

If the Pseudo-Tie request has passed all three tests above, the next step is to determine the necessary equipment needed to be modeled to properly dispatch the unit. To achieve this, a planning case Distribution Factor (DFAX) report is run by PJM Transmission Planning and reviewed by MMD for each unit. This analysis and review covers all equipment with a 3% DFAX on external facilities for a transfer of power from the requested Pseudo-Tie unit into PJM. Any equipment with a 3% or greater DFAX, for normally impacted facilities, and 3-5% for N-1 outage impacted facilities will be updated and/or modeled in the PJM EMS. This is to match the Native Balancing Authority's model, unless otherwise determined necessary, to properly dispatch the unit.

The work may be distributed over multiple model builds. The modeling updates needed to properly dispatch the Pseudo-Tied units should be completed in the PJM EMS at least two model builds (approximately six months) prior to implementation. This allows ample time to test the units with downstream applications and make any necessary changes prior to the Pseudo-Tie's implementation into the PJM model.

2.2.4 Naming and Modeling Standards

PJM utilizes a naming convention for modeling that consists of station/voltage/equipment name or ID. The following character limits apply for PJM naming of items:

- Company names are limited to five (5) characters
- Substation names are limited to eight (8) characters
- Voltage kV names are limited to eight (8) characters
- Equipment names or ID (device, generator, line, etc.) are limited to eight (8) characters

PJM also has several different naming conventions/standards that are utilized. In rare exceptions, engineering judgment is used as needed. Some of the current PJM modeling naming standards include:

- PJM makes every substation and generator name unique
- Generator and station names are to be named after localities or land marks to avoid confusion if sold.
 - The generator name is assigned by Infrastructure Coordination (IC) as referenced in Manual 14D Section 1.2.
- In certain cases where a piece of equipment (substation, generator, line, etc.) needs to have a unique name across the entire PJM model, discretion is used by PJM to determine a name to allow for uniqueness without removing the construct of the name from the TO/GO.
 - Example 1 – Substation named Springfield in companies ABC, DEF, and JKL. SPRNGFLD (ABC), SPNGFD (DEF) and SPRNGFD (JKL).
 - Example 2 – A line from Albany to Springfield would be ALB-SPRI. A new line going into the model from Albany to Springs would be modeled as ALB-SPR2.
- Switch names are generally named to match the TO name or as close to the name as possible. Dummy switches are utilized for state estimator and begin with DUM. These names are generic and are chosen by PJM.
- Line names follow an alphabetical convention using the first three (3) letters of the first (alphabetical) substation and the first four (4) letters of the second (alphabetical) substation (ABC-DEFG)
 - For example, a line between station ABCDE and station GHIJKL would be designated as ABC-GHIJ in the PJM model.
 - PJM ignores substation numbers in line naming
 - Example: line from 12 BCKLY to ALBANY would be designated as ALB-BCKL
 - When a substation name has a directional orientation as part of the substation name, only the first letter of the designation is used
 - Example: A line from NRTHALBY to WSTALBNY would be NAL-WALB
- The following standards are currently in use for naming Generating Units:
 - G-1: Generic Generator
 - GT: Gas Turbine/Combustion Turbine
 - ST: Steam
 - CC: Combined Cycle
 - DSL: Diesel
 - HYD: Hydro
 - WF: Wind farm
 - LF: Landfill

- o NUG: Non-Utility Generator
- o SP: Solar Park
- o BS: Battery Storage
- o SC: Synchronous Condenser
- o FC: Fuel Cell
- o BTM: Behind the Meter Generation
- o STAT: STATCOM
- o SVC: Static Var Compensator

2.2.5 Unique Device Considerations in the PJM Model

Some devices need to be modeled as units due to EMS limitations or downstream application limitations. Some of the devices that have unique considerations include:

- Variable Reactors
 - o Defined as a device which can adjust the VAR output based on system need.
 - o Currently, PJM does not have the ability to have a variable VAR output for a modeled cap/reactor therefore, a Voltage regulating unit is modeled to properly solve for the VAR output of the variable shunt device.
- Step Caps and Reactors
 - o Stepped shunt devices are classified as equipment that varies output based on a stepped approach (e.g., Step 1 = 25, Step 2 = 50, Step 3 = 75 MVAR).
 - o PJM does not have the ability to have a variable VAR output for a modeled cap/reactor, therefore, a Voltage regulating unit is modeled to properly solve for the VAR output of the variable shunt device.
- VFTs (variable frequency transformers)
 - o Infinite tap phase shifters that adjust based on system conditions are represented as generating units on each side of the VFT to represent power flow.
- Synchronous Condensers, STATCOMs, and SVCs
 - o VAR regulating units that are represented in the PJM model as generators with voltage control capabilities with no MW output.
- Deadband SVCs
 - o PJM models three separate units:
 - Boost – Modeled to add VARs into the system for voltage support to help boost the voltage during low voltage situations
 - Buck – Modeled to remove VARs from the system for voltage support to help reduce the voltage during high voltage situations
 - A regular unit is modeled to represent the non-deadband SVC which is used only when the deadband functionality is disabled for the SVC.

- It should be noted, this detailed modeling is not apparent on the dispatch one-line diagrams.
 - Only the total SVC is shown on the Dispatch one-line for simplicity.

2.3 PJM Bulk Electric System (BES) Transmission Facilities

See M-03, Transmission Operations, Section 1 Transmission Operations Requirements for descriptions, requirements, and discussions about:

- PJM Transmission Facilities
- Reportable Transmission Facilities
- Observable Transmission Facilities
- Monitored Transmission Facilities
- Monitoring Requested by the TO
- External Transmission Facilities
- Non-PJM Open Access Transmission Tariff (OATT) Transmission Facilities
- Transmission Facilities Not Monitored by PJM
- Local Facility Protection

Also see M-03, section 4.2.3, concerning energizing new facilities.

2.3.1 Prepare Initial BES Data to Denote BES Elements of the System

- TOs staff perform an initial review of existing systems to assess what is to be included or excluded to the current list of BES elements and provide necessary documentation to NERC.³
- TOs review existing systems to identify areas of existing systems operated between 50 and 100 kV. Facilities under 50 kV are deemed to not warrant modeling⁴.
- If facilities between 50 kV and 100 kV are ‘networked’, providing alternate flow paths to higher voltage equipment, TOs are to provide modeling and analysis details to PJM for joint assessment to determine if the system should be in the PJM EMS model. Assessment includes analysis provided by TO staff.

³ Refer to **Compliance Bulletin 14: Definition of Bulk Electric System (BES) – PJM Member Requirements** at <https://pjm.com/-/media/library/whitepapers/compliance/cb014-bulk-electric-system-definition-pjm-member-requirements.ashx?la=en>

⁴ See NERC technical guide for low voltage facilities loop threshold at <http://www.nerc.com/pa/RAPA/BES/BESExceptionEvaluationGuideline2-4-14REMGApp.pdf>

2.4 PJM Congestion Management Facilities

Facilities under PJM Congestion Management (or Reliability & Markets) Control

Note:

In this manual, the terms Congestion Management and Reliability & Markets will be used interchangeably.

PJM has developed standards that TOs must follow in order for PJM to operate generation to control loading or voltage on transmission facilities. See M-03, Transmission Operations, Section 1.

After all of the updates are made in eDART, the spreadsheets on PJM.com will reflect updated changes. To access the Transmission Facilities page, login to PJM.com and click Markets & Operations > Systems Operations. Under the Transmission section, click link for 'Transmission Facilities'. CEII approval is required to access the listing of Transmission Facilities. See Exhibit 2 for sample Transmission Facilities page on PJM.com reflecting latest updates to TO facilities.

<http://www.pjm.com/markets-and-operations/ops-analysis/transmission-facilities.aspx> See Exhibit 2 for sample Transmission Facilities page on PJM.com reflecting latest updates to TO facilities.

The screenshot displays the PJM website's 'Transmission Facilities' page. The left sidebar contains a navigation menu with categories like 'Operational Data', 'Data Directory', 'Interregional Data Map', 'PJM Tools', 'Energy Market', 'Capacity Market (RPM)', 'Financial Transmission Rights', 'Ancillary Services', 'Demand Response', 'Billing, Settlements & Credit', 'System Operations', 'Forecasted Generation Outage', 'Gas-Electric Coordination', 'Generation & Extra High Voltage Losses', 'Generation Outages for Seven Days by Type', 'Metered Load Data', 'Off Cost Operations', 'Operations Summary Data', 'Real-Time Scheduled Interchange', 'Synchronasor Technology', 'Transmission Facilities', and 'Advanced Technology Pilot Program'. The main content area is titled 'Transmission Facilities' and includes a brief description: 'The following lists identify facilities by transmission owner. The lists specify a limited set of attributes associated with a given facility, providing an overview of whether and how the facility is managed by PJM as part of regional and interregional operations.' Below this is a table of facility lists with columns for facility name, file type (XLS), and last updated date. The right sidebar features 'RELATED INFORMATION' with links to 'PJM Tools FAQs', 'Manuals', and 'Industry Groups', and 'RECENT DOCUMENTS' with a list of recent filings and notices. At the bottom right, there is a 'CONTACT INFORMATION' section for a Member Community, including the phone number (866) 400-8980 and (610) 666-8980.

Exhibit 2: Transmission Facilities Page on PJM.com

2.4.1 Telemetry Requirements for Facilities to be added to Congestion Management Control

For a transmission facility to be added to PJM Congestion Management Control, the facility must be “observable” (as defined in M-03, Section 1) with sufficient telemetry redundancy to ensure accurate and reliable SEs. Generally, telemetry requirements are noted below:

- Lines, phase shifters, or series device:
 - The branch has MW/MVAR telemetry at both ends and there is some MW/MVAR telemetry for other branches/injections at buses connecting to the branch, or
 - The branch has MW/MVAR telemetry at only one end and there is good MW/MVAR telemetry for other branches/injections at buses connecting to the branch, or
 - The branch has no MW/MVAR telemetry at either end but it has almost perfect MW/MVAR telemetry for other branches/injections at buses connecting to the branch.
- Buses:
 - Buses are “observable” if there is at least one voltage telemetry point and there is MW/MVAR telemetry for its branches and injections, or
 - The bus does not have any voltage telemetry point but a voltage telemetry point is available at the immediate neighbor bus (of the same voltage level) AND the bus being evaluated has all generation injections (for each generator connected and modeled) and most of the MW/MVAR telemetry for its branches and injections.

Refer to PJM Control Center and Data Exchange Requirements (M-01), Section 3 and PJM Transmission Operations Manual (M-03), Section 1 for additional details. PJM’s Manual for Generator Operational Requirements (M-14D) contains additional information about telemetry requirements.

2.4.2 Process to Change the PJM Congestion Management Control Facilities List

Background & Purpose:

Each year, TOs have an opportunity to nominate facilities to be included or removed from Congestion Management (a/k/a Reliability & Markets, or MP1). This entire process typically spans over a nine (9) month period and provides TOs the opportunity to request change on the following topics:

- Assume Congestion Management Control responsibility of additional transmission facilities
- Alter attributes such as ratings for all or most facilities of a given type when fundamental changes in assumptions or philosophy are required or
- Remove facilities from the Congestion Management list.

Beginning each year in July, PJM will send a spreadsheet of the facilities that have previously been submitted to PJM. Click the following link to access the PJM Transmission Services web site: <http://www.pjm.com/markets-and-operations/ops-analysis/transmission-facilities.aspx>

Each TO is responsible to review this spreadsheet and make the necessary changes. By September, TOs can submit changes for Reliability and Markets via email addressed to DMS_Officers@pjm.com. PJM posts all requests, with the exception of Reliability and Markets,

received by the following December, and between December and March conducts all the necessary analysis required for each Reliability and Markets change requests. In March, PJM posts the final results of the change requests, indicating whether the change request was approved or denied. By June 1, PJM implements all approved changes.

The following link to PJM Transmission Services Help Link explains the above-mentioned spreadsheet: <http://www.pjm.com/markets-and-operations/ops-analysis/transmission-facilities.aspx>

The table below outlines the description of events aligned with milestone dates/date ranges within the Process to Change the PJM Congestion Management Control Facilities List:

Timeframe	Description
By Sept 15	TO must verify that all additional transmission facilities to be nominated for inclusion in Congestion Management are properly modeled, with appropriate telemetry, in the PJM EMS model. (See Telemetry Requirements for Congestion Management Control below.) PJM staff is available to provide assistance if needed. EMS model adjustments must be coordinated with PJM’s deadline (Sept. 15) for the November update. Note that, as a part of the PJM EMS model update procedure, the TO must indicate whether a new construction facility will be under PJM congestion management control.
Sept 1 – Dec 1	TO must formally submit the request addressed to the DMS Officers (DMS_Officers@pjm.com) for PJM to: Assume Congestion Management Control responsibility of the additional facilities effective June 1 of the following year. All requested facilities must be transmission facilities, according to the FERC “seven-point” test, covered under Attachment H of the PJM OATT, and must be in the EMS model by the December model update. As a part of the request, the TO must submit the following: <ul style="list-style-type: none"> • Thermal ratings of the requested facilities, as per PJM Transmission Manual • Voltage limits of the requested facilities, as per PJM Transmission Manual • A recommended list of contingencies to be evaluated by PJM for the requested facilities
Dec 1 – Dec 8	PJM informs internal organizations of the proposed changes, including Market Operations, Operations Planning, Transmission & Interconnection Planning, Market Monitoring, etc., as appropriate. PJM will post all pending requests on the PJM Open Access Same-Time Information System (OASIS) website shortly after Dec 1 (link to PJM OASIS website: http://www.pjm.com/markets-and-operations/etools/oasis.aspx).
Dec 1 – Feb 15	PJM Market Operations, Market Development, and Market Monitoring will assess anticipated changes in congestion as a result of adding, removing or altering attributes (ratings) of facilities in the PJM congestion

Timeframe	Description
	management control list. PJM Transmission & Interconnection Planning performs analysis to ensure that the system resulting from the changes meets the PJM Reliability Planning Criteria or if any system problems result from the proposed changes. PJM Transmission performs telemetry and observability evaluation of incorporating the proposed changes. PJM Operations Planning performs operating studies and EMS studies to ensure reliable operations when the requested changes are included as part of PJM congestion management control.
By Feb 1	PJM coordinates changes with upcoming Auction Revenue Right (ARR) / Financial Transmission Right (FTR) auction (for June 1 to May 31 of the following year). The annual network AAR/FTR nomination period ends Mid-March.
By Feb 15	TO will be informed of the results of the planning, telemetry, and observability evaluations. Market Operations, Market Development, and Market Monitoring will report on their assessment of the impact on Congestion Management of the changes.
By Mar 1	TO will be notified by March 1 whether PJM can assume congestion management control on June 1. PJM informs appropriate internal organizations of the proposed changes, including Market Operations, Market Development, Operations Planning, Transmission & Interconnection Planning, Market Monitoring
Mar 1 – Mar 8	The list of requested facilities added, removed, or re-rated will be posted on PJM website to notify market participants of the changes in the list of facilities under PJM congestion management control effective June 1. For new construction facilities, the expected in-service dates will be posted.
By Jun 1	PJM adjusts (adds, changes, removes, etc.) congestion management control to accommodate the requested facility changes. For new construction facilities, PJM will assume congestion management control when the facilities are put in service.

For TOs integrated into PJM after September 1 of the previous year, requests to remove facilities currently under PJM congestion management will be accepted until Feb 1, to be effective June 1.

PJM reserves the right to grant exceptions to this timeline in order to maintain system reliability.

2.4.3 Process to Change Post Contingency Congestion Management Facilities

PJM supports a Post Contingency Congestion Management program. With this program, PJM will operate facilities beyond calculated post-contingency limits for select facilities. Only low-impact facilities are eligible for the program (i.e., will not contribute to system cascading). The TO must submit a formal request to PJM to request an exception for PJM Operations to accept an automatic switching scheme at a specific location. The TO must attach necessary

documentation and study results demonstrating the scheme will function under all operating conditions as designed.

TOs must identify the facilities under consideration for Post Contingency Congestion Management, along with the remedial action scheme to be employed (switching, generator ramping, etc.), and any attributes, such as ratings, which are to be altered. This information is required along with the documentation and study results noted above.

Changes to the Post Contingency Congestion Management Facilities (additions, changes, or removals), are initiated by the TO via request to the manager of PJM's Transmissions Operations Department. Changes will be implemented following the same timeline as the Process to Change the PJM Congestion Management Control Facilities List schedule listed above.

For information about PJM's Post Contingency Management program, see M-03 Transmission Operations. M-03 also includes Attachment D: Post Contingency Congestion Management Program, which documents facilities which have been approved and are eligible for the Post Contingency Congestion Management Program.

Section 3: EMS Data Collection Process

Welcome to the EMS Data Collection Process section of the **PJM Manual for EMS Model Updates and Quality Assurance**. In this section you will find the following information:

- Background on PJM EMS System Model Updates
- PJM Transmission System Model Update/Data Collection Procedures
- PJM Ratings Data (Thermal Equipment Ratings Monitor (TERM))
- Interim Update Capability
- Naming Conventions

3.1 Background on PJM EMS System Model Updates

This section is intended to describe the philosophy guiding PJM's EMS model update and validation procedures, specifically identifying feedback and information about the PJM models available to users. At the present time, it is not intended to serve as a detailed user's guide or training manual for those involved in the day-to-day business of updating models.

PJM's operating footprint encompasses all or portions of District of Columbia, Delaware, Illinois, Indiana, Kentucky, Maryland, Michigan, New Jersey, North Carolina, Ohio, Pennsylvania, Tennessee, Virginia, and West Virginia. Modeling such a large system and keeping the model up-to-date is a complex process requiring cooperation between PJM and member companies, as well as neighboring or 'electrically close' utilities, RTOs, etc. The models are developed for multiple purposes, including:

- Real-Time State Estimation (SE)
- Security Analysis (SA)
- Transient Stability and Voltage Stability Assessment (TSA/VSA)
- Study-mode simulations for short-term operations analysis (primarily outage planning), as well as Day-ahead Markets
- Real-Time LMP (RTLMP) and Security Constrained Economic Dispatch (SCED) calculations
- FTR auctions

In addition, tie-line and tie-line metering data is translated for use in PJM Generation Control algorithms.

The SOS-T representative is responsible for models of their system. Typically, the SOS-T representative designates an alternate or relies upon the DMS member to provide information in accordance with PJM schedules.

eDART's Network Model application is used to collect data needed to model planned system changes. This data is interpreted and coded to prepare updates and input for the Siemens suite of EMS network applications (i.e., SE, SA, etc.). In addition, the model changes are forwarded to other PJM groups to incorporate these changes, as appropriate, into models used

by Day-Ahead Markets, etc. Changes such as new tie-lines, which impact AGC systems, are also derived from the changes submitted as part of the model build process.

There are many inter-dependent systems and multiple stakeholders utilizing the basic model data, which requires significant coordination. Consequently, PJM restricts regularly-scheduled updates of the EMS model to four (4) times each year.

Two of these updates, commonly known as the summer and winter builds, follow a formal process with TOs providing input. Data which may impact models is also gathered by PJM staff from the PJM Regional Transmission Expansion Plan (RTEP) as well as the Generation and Merchant Transmission Queues. Each model build incorporates electrical grid modifications resulting from the near-term, future transmission, and generation construction projects reported by TOs and GOs throughout the PJM footprint. Two other EMS updates are performed each year. These builds are focused on updating or expanding the external system models as required but also serve as additional opportunities to correct known problems with PJM GO and TO facilities.

Limiting model builds to four (4) times per year ensures a 'stable' model for all stakeholders/participants.

Although fairly common practice in the industry, a 'just in time' approach to model building (i.e., performing updates as construction projects are completed) is not feasible in the PJM environment. As a result, PJM employs a 'double-model' strategy. Existing substation configurations as well as the planned configurations are modeled. The double model permits PJM to re-configure the model online to reflect the connectivity of new construction and to retire equipment online as necessary. PJM typically employs 'dummy' switches to incorporate the pre- and post-construction configuration.

Although developed initially for reliability purposes, the EMS model updates also serve as the basis for updates to the commercial models used in PJM Market programs. Commercial model support staff members modify and adapt the network model for use with these Market applications. Hence, the Operations and Markets models are essentially identical. After extensive testing, PJM transfers new EMS and Market system models into production concurrently.

Many other PJM database and application systems depend upon the EMS network model and the EMS model update process and these other systems receive one or more of the following:

- a full copy of the EMS network model
- a data extract from one of the EMS databases
- a list of incremental EMS changes
- a PSS/E conversion of the EMS network model

Implementation of the data from the new model builds is also coordinated with other PJM applications such as eDART (Outage Scheduling, TERM, etc.), SCADA, SCED, RTLMP, OTS, TSA, AGC, M2M, OASIS, etc.

3.2 PJM Transmission System Model Update/Data Collection Procedures

Periodic updates to the PJM EMS are required. A key to maintaining accurate PJM reliability and market models is timely submission of the transmission model changes. There are essentially two types of changes: 1) Topology changes and 2) Parameter changes. Parameter changes include line impedances, and ratings and transformer tap settings. Rating and line impedance changes should be entered via the eDART TERM application. Advance or early notification is essential for topology changes. TOs are required to notify PJM from six (6) months to one (1) year in advance of system topology changes. The timeline relates directly to energization of new equipment. This is especially important to note for phased projects. While a network model submission can be made up of multiple phases, the submission requirement is based on the energization of the earliest piece of equipment in the submission. In lieu of this, if equipment energization dates are separated by a significant amount of time multiple Network Model requests are required.

The elements of the system to be monitored for possible limit violations is defined in the EMS and posted on the PJM OASIS website under System Information in the Ratings.txt file which is updated daily (link to PJM OASIS: <http://www.pjm.com/markets-and-operations/etools/oasis.aspx>).

The EMS network model is updated quarterly each year to reflect the TO topology changes. As future equipment is cut-in, parameter changes reflect the recent known values. Model topology updates are targeted for completion in May (summer), and December (winter). The March (spring) and September (fall) updates are used primarily for clean-up of the winter and summer builds respectively. To be assured that a facility addition, revision, or deletion is included in an EMS quarterly model update, all technical modeling information must be submitted to PJM's Power Systems Modeling Department by the published data close deadlines posted on the DMS web site at: <https://www.pjm.com/committees-and-groups/subcommittees/dms.aspx>. Note that the schedule can change per coordination and communication of DMS members by the DMS officers.

Note:

Overall guidance for submission timeline for model update artifacts are outlined in Appendix E: Checklist for New Equipment Energization Process. Please refer to Appendix E for further details.

Periodic checking of the website is encouraged. Data close dates are also posted on the PJM Calendar as "System Changes."

Quarterly Build Name	Build Type	Information Submission Close Date Timeframe	EMS Model Update Date	Required In-Service Date for Project	Preferred In-Service Date for Project
Spring	Interim ⁵	Late November	March	April - Sept.	October + 11 months
Summer	Formal	Early February	May	June - Nov.	December + 11 months
Fall	Interim	Early June	September	Oct. - March	April + 11 months. -
Winter	Formal	Early September	December	Jan. - June	July + 11 months

General Schedule for Submitting Modeling Data

Each summer and winter update schedule follows a similar timeline pattern. Prior to the scheduled model change-over production date, TOs are notified several months in advance of the target due date that the PJM EMS model will be updated, and specific requirements are clarified for topics including: 1) Projects in-service near term; 2) Major Projects; 3) Model Schedule; 4) Complete Model Submissions; and 5) Tie Lines. These notices are typically emailed by January for the summer update, and by July for the winter update.

For more information on the model build schedule and any other issues related to the transfer of modeling data for electric system models, click the following link to the DMS webpage at: <http://www.pjm.com/committees-and-groups/subcommittees/dms.aspx>. DMS members can also gain further information at the secure DMS SharePoint Web site.

3.2.1 TO and PJM Staff Responsibilities

TO Staff Responsibilities - To Address BES Definitions:

- NERC assigns each TO responsibility for evaluating what elements are included in the BES and notifying NERC of any exceptions. To ensure that BES and non-BES elements are modeled by PJM, TOs must also notify the Power Systems Modeling Department (PSM) by e-Mailing the PJM distribution group: DMS_Officers@pjm.com
- Once notified that additional sub-transmission facilities are to become part of the BES, PJM staff will review the request. To perform this evaluation TOs must provide a diagram of the area and complete modeling details (see section 2.2 of this manual for details). PJM requires telemetered MW/MVAR pairs for line flows and either loads or transformers (may also require tap information) in addition to status points to support near real-time automatic evaluations of connectivity⁶. TO staff shall also denote available telemetry for the elements to be modeled.

⁵ Projects submitted during Interim Build periods are included per PJM discretion. PJM recommends that TOs submit major projects during Formal Build timeframes to ensure inclusion in next build.

- The above stated information is to be provided via the eDART Network Model tool. TOs are responsible for identifying future BES facility additions/deletions as part of the RTEP and EMS Model quarterly update processes.
- Representatives for each TO shall provide justification and analysis of all requested sub-transmission facilities and coordinate modifications of BES with PJM MMD staff.

PJM Staff Responsibilities - To Address Revised BES Definitions:

- To assist with maintaining the data, PJM will incorporate a review of BES facilities as part of the annual review of Tariff Facilities, per a BES flag in the posted Tariff Facility data.
- As part of the ongoing model update process, any modifications to the model and BES element list should be included as part of the EMS quarterly Model Update or RTEP processes, respectively.

PJM Staff Responsibilities - Ongoing Sub-transmission Modeling Considerations:

- Data requirements for EMS models shall adhere to the specifications in this Manual. PJM staff shall facilitate discussions at the Data Management Subcommittee (DMS) meetings to clarify and explain the sub-transmission modeling practices. The sub-transmission data submission shall include justification for inclusion in the EMS model and indicate if the facilities are to be considered BES elements. NERC regions have ultimate responsibility and approval for designating equipment as BES or non-BES.
- The need to expand the model, particularly to incorporate sub-transmission elements, can be identified through the PJM outage assessment process (see PJM Manual 38). If PJM staff initiates the request, coordination with the TO staff shall:
 - Gain the TO's acceptance;
 - Facilitate required NERC notifications;
 - Prepare complete, timely and clear modeling data.
- PJM staff shall work with TOs to ensure that all concerned have a common and full understanding of any modeling changes required.
- Any non-BES nominated sub-transmission facility additions to the PJM EMS model will be addressed on a case-by-case basis following the procedure documented in PJM Manuals.
- The cited examples of sub-transmission facility modeling are typically driven by actual operational experience and engineering assessment/experience.
- Each year around the middle of July, PJM sends out a list to each TO of all equipment that is currently modeled in PJM EMS. This list includes PJM Transmission Facilities Reportable Transmission Facilities, Observable Transmission Facilities and Transmission Facilities Not Monitored by PJM. Each TO must review this list for accuracy. TOs must identify equipment listed as a BES Facility or Non-BES Facility (column M - circled). See the below Exhibit for a sample Facilities List.⁷

⁶ See PJM Manuals M-01, Control Center and Data Exchange Requirements, and M-03A EMS Model Updates and Quality Assurance, et al.

⁷ See TOP 001-4 at: <https://www.nerc.com/pa/Stand/Reliability%20Standards/TOP-001-4.pdf>

PJM Interconnection, L.L.C
Last Updated on 5/31/2019
PJM Transmission Providers FACILITIES LIST

The following list includes, but is not limited to, facilities of the regional transmission owners that are included in PJM's EMS model. FERC Form-1 or equivalent facilities are so noted under the column headed PJM OAT Tariff Facility. This list will be updated when transmission facilities managed by PJM are added to, or deleted from, the electrical network.

[PJM Transmission Providers Facilities List On-Line Help\(PDF\)](#)

Equipment Code:
 1 - Transmission Line
 2 - Transformer or Phase Shifter
 3 - Shunt Capacitor or Reactor
 4 - Series Reactor or Capacitor
 5 - SVC Device
 6 - Other Substation Equipment-Busses, Bus Sections, or Breakers
 7 - Tie-line
 8 - Generator Step Up (GSU) transformer
 (List by Station and Voltage Level or Device Name)
 9 - Flow CB
 10 - Equipment

Company ABC

Mark column K as:
 Yes = Reportable and Call in
 Low = Reportable, status available will not call in unless unusual circumstances
 No = No call and no status

(A)	(B)	(C)	(D)	(E)	(F)	(G)	(H)	(I)	(J)	(K)	(L)	(M)
PJM EMS MODEL FACILITY NAME												
Equip Code	ID	Facility Identification by Transmission Prov	B1_NAME	B2_NAME	B3_NAME	B3 TEXT	Voltage	PJM OAT Tariff Facility (Y/N)	Included in EMS Model (Y/N)	Reportable in Transmission Facility (Y/N)	PJM Monitored Facility Status	BES Flag
1	1234	Happy - Gloomy 138KV	HAPPY	138KV	HAP-GLOO	HAPPY - GLOOMY 1234	138	Yes	Yes	Yes	Reliability & Markets	True
1	567	Land - Sky 500KV	LAND	500KV	LAN-SKY	LAND - SKY 567	500	Yes	Yes	Yes	Reliability & Markets	True
1	8910	Broad Tap - Street Rd 230KV	BRODTAP	230KV	BRO-STR	BROAD TAP - STREET RD 8910	230	Yes	Yes	Yes	Reliability & Markets	True
1	1111	Sun - Shine 230KV	SUN	230KV	SUM-SHI	SUN - SHINE 1111	230	Yes	Yes	Yes	Reliability & Markets	True

Sample TO Facilities List

Phased Projects:

Phased projects is work that will be built and energized in stages throughout the life cycle of a project. A Network Model ticket must be submitted in the appropriate build for each phase of the project in order for equipment to be energized on time. Equipment must be in the PJM model six-to-12 months prior to energization. This timeline supports PJM's Outage Analysis process, which requires all equipment to be in the PJM model so that six-month-out studies can be performed.

Note:

Example: An outage is planned to start in September. TO submits the model change in the eDART Network Model Application for the preceding Spring Model Build. Change goes into production in March (six months prior to planned outage in September).

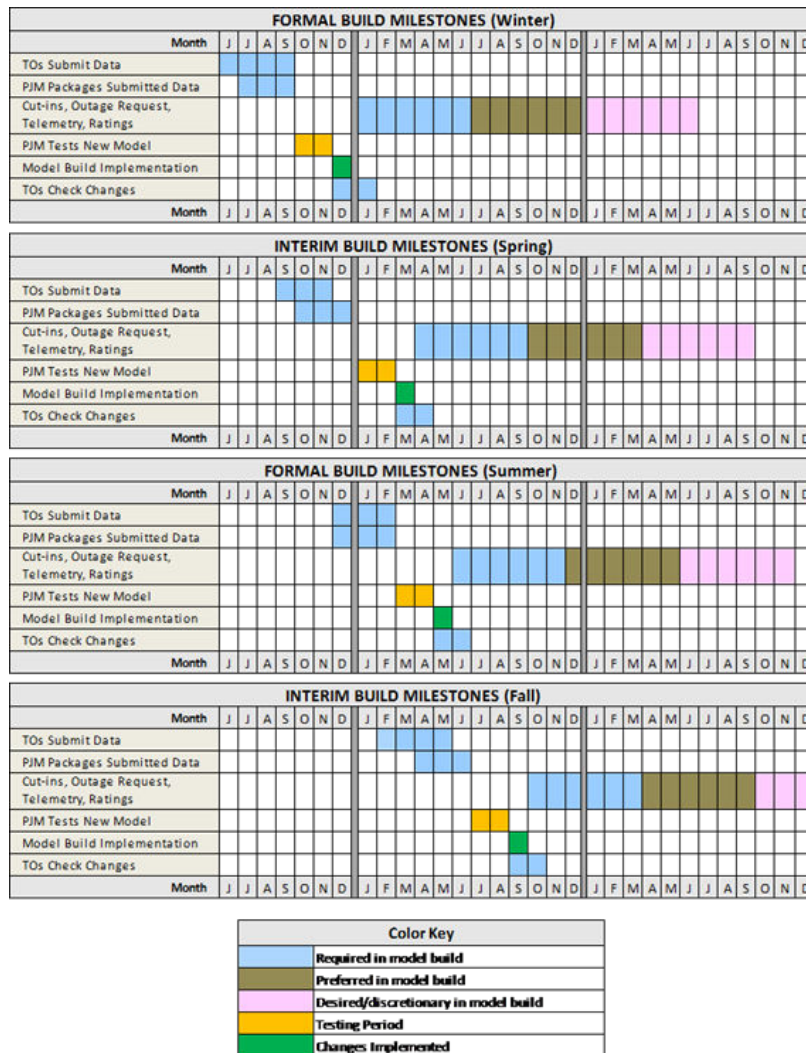

Exhibit 3: Network Model Data Submission & Model Validation Timeline

As part of PJM Staff coordination efforts of these data requests, a list of RTEP-related projects on record in PJM’s generation and transmission planning queues is attached for the TOs to review. TOs are expected to review the projects on record at PJM and validate that they correlate with information available internally; reporting any differences to their PJM EMS data modeling representative involved with coordination the data collection process. Once identified by TO staff review efforts, these differences are reported back to PJM planners who review the information with TO planning organizations to reconcile any differences.

In addition to the baseline upgrades on record at PJM, any changes that TOs are making to their system outside of the RTEP process are required to be submitted to PJM Planning staff. These changes are known as Supplemental Upgrades. For overview training of the submission process, please see Training-Transmission Planning, Modeling & Energization-RTEP Process at <http://pjm.com/markets-and-operations/ops-analysis.aspx>. Manual requirements for upgrade submission are contained in Manual 14B: PJM Region Transmission Planning Process, Section 1.1: Planning Process Work Flow.

PJM's goal is to prepare model additions well in advance of actual construction. TOs are responsible for providing data about all construction projects that will impact the PJM model during the coming six month period. This six month period (window) is defined as construction to be started and/or completed from June 1 through Dec. 31 for the summer build and as construction to be started and/or completed from Jan. 1 through May 31 for the winter build. It is of interest to point out that the PJM Summer build includes construction that will be occurring in preparation for winter peak load periods and the PJM Winter build includes construction that will be occurring in preparation for summer peak load periods.

Because construction completion deadlines can be tentative or variable, PJM prefers to operate on the conservative side. That is, PJM will accept data for projects beyond the six month window even though TOs indicate there is some uncertainty about the completion date, provided: 1) there is a high confidence that the project will be funded and completed in the subsequent 6 to 12 month period; and 2) a fully complete data model submission can be made by the data submission close date.

TO representatives should use the eDART Network Model application to submit and record the required model update changes. The system requires users to provide station name and company, a project description in-service date, and Voltage level for each project. Note that the user is then prompted to select from a drop-down list of existing substations in their model to make changes or to enter a new substation name. The required set of complete data can be provided in one of two methods: 1) Files attached as part of an eDART Network Model submission that contains all the required data (diagrams, spreadsheets, PowerPoint, etc.), or 2) Using the forms in the eDART Network Model application. Option 2 information entry is as follows:

- Additional prompts provided which can be used to illustrate all the equipment presently modeled at PJM within each substation (breakers/switches, lines, loads, series devices, shunts, SVCs/generators, phase-shifters and two-winding transformers). Users are required to enter data through the appropriate forms modifying existing equipment by selecting the device to be modified and/or enter data to describe new equipment. Descriptions of each field are incorporated into the data collection tool. Users can also download one-line diagrams for each substation modeled by PJM within their service territory and other zones within the PJM footprint where permission has been granted.

Forms for each type of equipment in the EMS database (breakers, lines, transformers, shunts, series devices, phase shifters, loads, generators/SVCs) have been created and can be referenced through the eDART Network Model (data collection) application. Users **are required** to provide the following general data items for a full and complete submission:

- One-line of the project which is to be attached as a file to the project
- Title that has a summary of what the update involves [100 chars.]
- Primary Voltage Level in kV entered in separate field
- Description that expands on title giving the EMS modeler a broad picture and specifics of what is the focus and timetable of the required change In-service dates for the project and individual equipment if phased in
- In-service dates as submitted as part of the Network Model update process can be approximate dates

- All stations that have updates for this submission shall be listed/selected by using the Stations button
- Names used internally for the various devices (including Switch names)
- Impedances in p.u. on 100 mVA for lines, transformers, series devices, and other parameter devices
- Loads, estimated peak load (MW & MVAR)
- Shunt size (MVAR) – for dead band SVCs, see Section 2.2 Requirements
- Phase shifter taps and MW/Phase Angle targets and range
- Available telemetry (both analog (MW & MVAR flows) and digitals (switch open/close status))
- Transformer parameters including nominal voltages and taps
- SCADA linkages
- Denote clearly if the project involves tie-lines (i.e., different TO companies) indicating if internal to PJM or external to PJM. Note that this should follow the existing PJM Tie Line Process. Select the Tie Line check box.
- If Generation related, select the Generator check box
- Denote the TO specific Company Project ID
- Denote the PJM upgrade ID as appropriate in the RTEP/Gen Queue field
- List the project phase in-service dates in the Phase Project section field for any phased projects
- Each phase requires its own Network Model Request per build cycle
- Network Model Ticket/Outage Cut-in ticket linkage, if applicable

PJM staff members are responsible for preparing Network Model Update Packets which include:

- A marked-up PJM EMS display one-line for each impacted substation
- Creating a one-line display for any new substation to be modeled by PJM
- In-service dates and project ID are noted on the one-lines
- Dummy switches used to convert from existing to future configurations
- Pertinent information for operators will be noted on the one-lines
- Diagrams and other information provided by TO staffs or PJM Operations staff
- Clear identification of tie-lines

Timeliness of Network Model ticket submission is tracked by the system via the “Submit On-Time” field on each ticket. Network Model tickets that are submitted in accordance with PJM’s model update process and deadlines will be marked as “On-Time”. Tickets that are created or revised after the data close date of the selected “Target Model Build” will be marked as “Late”. Once the submit button is clicked for a late ticket, a notice will appear to indicate the submission is late.

The TO shall contact the PJM model coordinator to provide notification for each late ticket that has been submitted or revised. Late tickets which address adverse impacts to real-time operations may be included in the target model build at PJM's discretion on a case by case basis, but the ticket will remain marked as late. All other late tickets will be deferred to the following build. Metrics of all late tickets for a given build will be monitored and may be reported to SOS-T.

PJM staff members are responsible for interfacing the necessary generation data and models to be used. If TOs have information about the various generation projects in their areas, it is recommended that this data be submitted as a project or validated as previously modeled. Generator information is derived directly from the PJM generation planning queue information and will be correlated with information provided by TOs regarding generation projects within their 'footprint'.

TOs are encouraged to provide data to represent updates to occur on their systems to the degree they feel appropriate. PJM reserves the right to make adjustments deemed appropriate and sufficient to model and support PJM's mission to support BES reliability and economics. As a result, PJM may elect not to model everything the TO provides. Therefore, the PJM model is expected to be similar to, but not necessarily the same as, individual TO real-time or planning models.

Tie-line projects require extra attention, especially those involving ties with non-PJM entities as they impact the control area signals required for AGC. Consequently, projects involving tie-lines need to be clearly identified using the Tie-Line of the eDART Network Model application.

PJM also recognizes that not all project data may be available 6-12 months before cut-in. TOs are requested to provide information to the best of their ability, per industry best practices and per modeling discussion and consensus per the secure DMS SharePoint web site, to meet the scheduled data submission close dates. It is encouraged that TO EMS modeling staff members contact planners in their organizations to obtain In-Service Dates (ISD), approximate impedances, equipment names or reference the data from applicable MMWG cases, etc. ISD is required and, if tentative, should be a conservative estimate (earlier). When more exact parameter data becomes available, TOs are required to update the project's initial parameter data using the eDART TERM tool for Line impedances and ratings updates. For example, SCADA information and ratings data are often not available initially. It is the responsibility of the TO staff to submit appropriate data to PJM as soon as it is available. The data must be received by PJM no later than two (2) weeks prior to the scheduled cut-in.

Note:

EHV Modeling: For both: 1) 345 kV and greater transmission lines, and 2) 500 kV and above transformers (with low side => 230 kV), model submittal should be at least one year in advance of the scheduled energization (cut-in) date.

Note:

Requirements for which facilities require ratings are outlined in Exhibit 15: List of Monitored Priorities in Appendix C.

If updates are needed for topology information, such as for switch or equipment names, a new Network Model ticket shall be submitted. Note that it is required that TO staffs review and verify these initial projects and their associated parameters within two (2) weeks of receiving the

update information from each model build. If a Cut-in Transmission Outage Ticket (TOT) exists for the new configuration identified in the Network Model request, a linkage should be made from the Network Model Request to the Cut-in TOT. See <http://pjm.com/markets-and-operations/ops-analysis.aspx> under Training -Transmission Planning, Modeling & Energization - Additional Functions Part 2 for further details.

TO-Specific Review Items

To ensure the PJM Model is appropriately in sync with TO models, TO should review the following summary information as it becomes available:

- Updated one-lines available via the DMS SharePoint site and Network Model applications
- Reports listing Network Model request that are in your zone via the Network Model application and the DMS SharePoint
- Preliminary and final difference reports posted emailed to SOS-T and DMS-Confidential groups
- Postings of other model related information on DMS SharePoint and DMS Workplace sites

Any discrepancies or updates identified when performing these reviews must be submitted as a Network Model Request and will be treated as a new submission and will be processed by PJM staff according to the model build schedule.

Geographic Information System (GIS) Data Submission

Each TO is required to supply PJM with the GIS Coordinates for any new stations in their company model (Latitude/Longitude). After each quarterly model build goes into production (four (4) times per year), PJM will forward the new station names included in the model build to the TOs. TOs will then return the GIS Coordinates (Latitude/Longitude) for each newly-added station name in the PJM model. The figure below illustrates the relative level of detail for areas modeled in the PJM EMS.

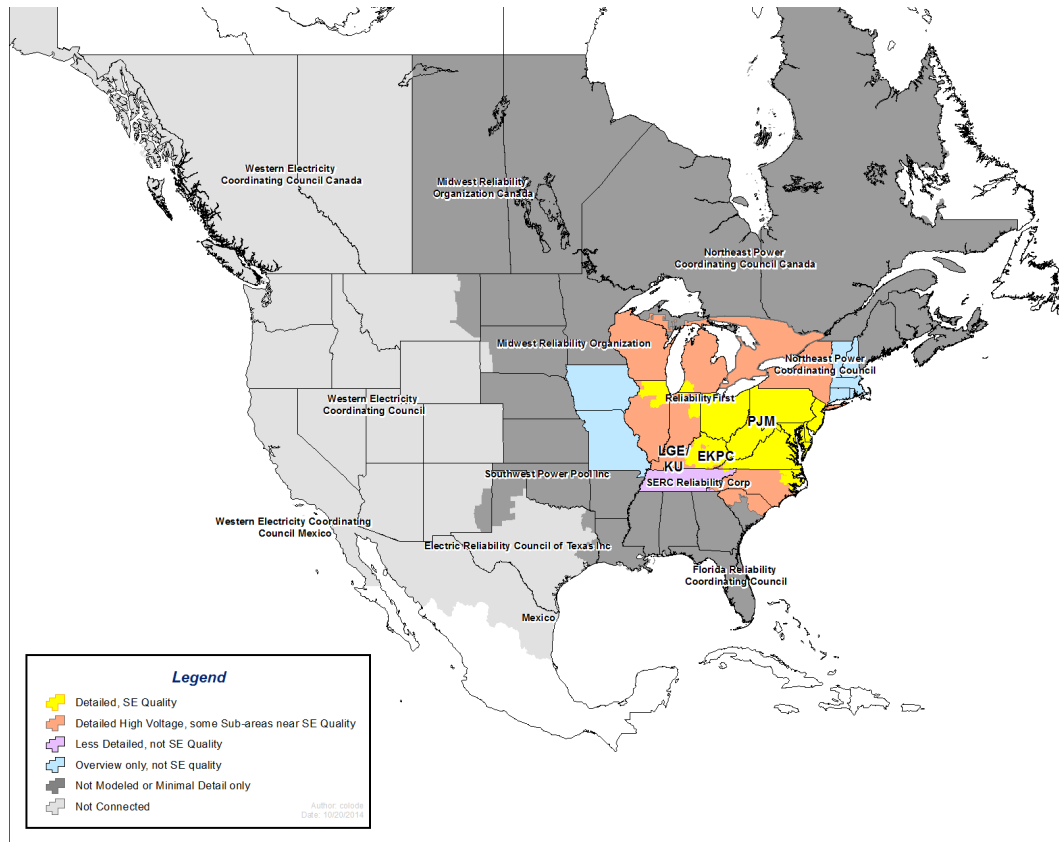

Exhibit 4: PJM EMS Model Details

3.3 PJM Ratings Data (Thermal Equipment Ratings Monitor – TERM)

Another eDART application is TERM. All facilities in the PJM EMS model are transferred to eDART immediately after each model update build. TOs should be able to enter ratings data in accordance with PJM policy for each facility in the database – lines, transformers, series devices, phase shifters, and flow breakers. PJM requires ratings for eight (8) temperature sets: 95, 86, 77, 68, 59, 50, 41, and 32 degrees Fahrenheit. Users can also differentiate between day and night limits by entering values reflecting direct solar heating of conductors.

In addition, PJM systems expect Normal (continuous), Emergency (equipment capability for up to four (4) hours with long-term and short-term emergency set equal unless specifically approved otherwise), and Load Dump limits (equipment capability for up to 15 minutes’ duration). These represent progressively increasing severity of loading. See Section 2 Facility Ratings Definitions and Data Procedures in M03 Thermal Operating Guidelines for more information on how PJM operators use ratings information. Also see Appendix A of this document for more information regarding processing TERM tickets at PJM.

See Section 2 How to Change Facility Ratings in M03 Transmission Operating Guidelines for additional information about TERM usage as well as bulk loading ratings updates.

3.4 Interim Update Capability

PJM's EMS is capable of performing some limited, interim updates as required. This practice is not a preferred operating practice and is primarily utilized when impedances need to be revised. If there are model problems, TO and GO representatives are encouraged to contact PJM to review the situation and determine if and when corrections can be made. The eDART Base Data section of TERM provides the ability for users to view existing resistance, reactance, and susceptance information (R, X, B) and input R, X, B adjustments. Only impedance revisions which are expected to have a significant impact on the SE solution will be implemented immediately, with others processed as part of the routine build process.

Changes to transformers and shunts can be performed outside of the quarterly model build process. These need to be communicated to PJM via email to NA_TEAM@pjm.com. Any temporary or permanent changes in the sizes of shunt devices should be included as a transmission outage ticket in eDART to make the changes to the system between model builds. It is also requested that a Network Model ticket is submitted to identify this change to fully review and complete any additional modeling work as a result of the change as necessary.

Any transformer changes occurring outside of a model build that relate to nominal voltages or load tap changers (LTC) need to be communicated to PJM via e-mail to NA_TEAM@PJM.COM. The e-mail shall contain changes for the high and low side nominal voltage and/or changes to LTC parameters. LTC parameter changes can only be made if the transformer has already been designated as such in the PJM EMS, otherwise, a model build is required.

Section 4: EMS Model Change Control and Feedback

Welcome to the EMS Model Change Control & Feedback section of the **PJM Manual for EMS Model Updates and Quality Assurance**. In this section, you will find the following information:

Describe feedback and data available to TOs regarding their models, including:

- Overview of EMS Model Change Control and Feedback
- Bus Connectivity and Engineering Data
- Substation Nodal Connectivity
- Processing Tie-Lines
- Cut-ins and Contingencies
- SCADA Mapping
- One-line Life Cycle
- Data Management Subcommittee
- Sub-Transmission Modeling Overview

4.1 Overview of EMS Model Change Control and Feedback

PJM collaborates and exchanges data with all PJM member TOs to provide up-to-date BES models and, therefore, the best analysis to operators for reliability and commercial evaluations of the BES system. PJM has on-going, continuous coordination efforts to improve the information available to TO staff participating in the EMS model quarterly update process. The type of feedback required is two-fold: First, and foremost, participants in the model building process need to receive confirmation, and validate that the changes they've submitted have been correctly incorporated into the PJM EMS models. Second, participants in the process exchange information about changes submitted by others so they can then appropriately modify their internal real-time models. Due to confidentiality restrictions, PJM adheres to the agreements in place per the PJM Stakeholder process to share confidential EMS data models among the appropriate TO staffs. The distribution of information about the changes made to PJM models may be restricted.

To improve feedback to participants in the data gathering process, PJM provides summaries of model changes placed in the production PJM EMS model. Since, as noted earlier in this document, SOS-T members are designated as the 'owners' responsible for transmission models of their system, model change data is channeled through representatives of that group, and their designees whom are members of the DMS.

The data made available is summarized in more than one format, with the below spreadsheet format shown in Exhibit 5 as a Sample for a typical Model Update Build Summary. Other summaries are also provided to address TO staff requests per Industry requirements. These types of summaries are communicated via secure web sites and confidential meetings.

Summer 2014 Build Summary

Network Model ID	Company	Project Title Description
NNNN	CO1	Grand Jct. (CO1): transfer 138 kV Tap to Schneider Ville to new 138 kV position. Install new 138 kV breakers. ISD 12/25/2014.

Exhibit 5: Sample Model Update Build Summary

Detailed model change information is also summarized and provided on a substation and equipment level, along with a snapshot view of the EMS one-lines in use at PJM at the time of the most recent model build. Preliminary detailed reports are made available to TOs providing the preliminary model update information as soon as practical after installing the new model on the PJM Production Test system. However, users are cautioned that the preliminary data is subject to change as described in section 5.2.3 Validation & Benchmarking New EMS Models.

TOs have multiple views of the EMS data base available to them, including eDART connectivity information and coordination efforts of power flow specifics provided to TOs to support day-ahead planning (note that Market models are based on the PJM EMS model). The DMS SharePoint site posts the quarterly engineering equipment data for the PJM Footprint such as impedances, loads, etc. (Note: Impedance data is also available to TOs via eDART/TERM application forms.) In addition, the eDART Network Model application allows users to access copies of PJM's EMS one-line diagrams (in SVG format). PJM constructs EMS one-lines to reflect both existing and future conditions. Participants that adhere to the established EMS model update schedules are able to view planned changes in advance since new projects and system changes are included in the PJM models months before going into service (see the schedule at: <https://pjm.com/-/media/committees-groups/subcommittees/dms/postings/build-schedule.ashx?la=en>), per the Network Model Data Submission & Model Validation Timeline shown in Exhibit 3). However, the new equipment will remain switched out of service until it is energized in the field. Upon completion of each quarterly EMS build, PJM issues a model difference report which is a tabular summary of all changes. PJM makes details of the changes available to SOS-T and DMS through the DMS SharePoint postings. (PJM requires proper DMS appointments for access to the DMS SharePoint site.) It is the responsibility of participants in the model building process to review the changes in the model difference report summary, one-line diagrams, etc.

SOS-T members or their representatives are charged to validate that PJM represents their systems accurately and to provide corrections as required. Several additional mechanisms have been made available as support for this process has evolved to supplement eDART connectivity information.

PJM reserves the right to initiate selective model audits, with the support of SOS-T.

PJM provides information for TOs to review and validate their models. It is expected that SOS-T and DMS members will use the data available to them to develop processes internal to their organizations to verify that the PJM models correctly represent the connectivity and engineering data provided by them to PJM. This data is now available through a variety of mechanisms. A discussion of more advanced mechanisms intended for use by TOs to validate engineering data and substation nodal connectivity follows in Section 4.2. TOs are expected to review the

available information and provide feedback regarding improvements within two (2) weeks of receiving the update information from each model build.

TO staffs are responsible for providing data according to the established schedules and for reviewing information and providing corrections as required.

Regularly scheduled meetings of the DMS hosted by PJM are an opportunity for TOs to obtain feedback about projects in adjacent utilities. These meetings are held in February, May, and November. Further information on DMS postings, upcoming meetings, and meeting materials can be found on the publically available DMS webpage (<http://www.pjm.com/committees-and-groups/subcommittees/dms.aspx>) and on the secure DMS SharePoint site.

Specific information can also be made available upon SOS-T or DMS members' request. The secure DMS SharePoint site allows TO staffs to share data recorded in the eDART Network Model application with each other.

4.2 Bus Connectivity and Engineering Data

PJM provides feedback to TOs regarding bus level connectivity and engineering data in a variety of formats. TOs are encouraged to take advantage of accessing the data available to them. Ratings and impedance data (R, X, B) of lines, transformers, phase shifters, and series devices is available to approved transmission users of eDART in the Base Data section in TERM. Users can also view Monitored Priority status of their facilities and have ability to submit tickets for impedance changes. It is anticipated that the changes submitted will primarily address situations when preliminary data was initially used to model a construction project and that actual data then is found to be different upon completion of the project. In addition, the application can be used for error corrections. PJM staff addresses these changes online without a complete EMS model build.

4.3 Substation Nodal Connectivity

eDART is populated directly from the EMS model after the completion of each build. Equipment B3 text names and nodal connectivity information is available through the eDART Transmission Outage Ticket application. Connectivity information is also provided to users by eDART via 'tiers'. With this feature, users can view model components up to three (3) connections from the location they are currently viewing.

In addition to creating change requests describing new equipment, the eDART Data Collection/Model Update function allow users to recall information about existing substations. The information displayed includes all equipment modeled within the substation (B3 names, lines, phase shifters, transformers, shunts, breakers, switches, series devices, and SVCs/generators). Engineering data such as impedances, voltage levels, tap sizes, etc. is also presented on the forms used to describe the various pieces of equipment in this new software.

In addition to the engineering data feedback, the new eDART functionality makes 'snapshots' of PJM EMS one-lines (static data only) available to users through the Network Model application. The snapshots detail substation lay-outs as modeled in the PJM EMS and used by PJM operators. Due to confidentiality restrictions, the one-lines available are restricted to those substations owned by the TO accessing the data and other zones within the PJM RTO for which

the company has been given the approval to view. See Exhibit 6 for PJM One-line diagram symbols.

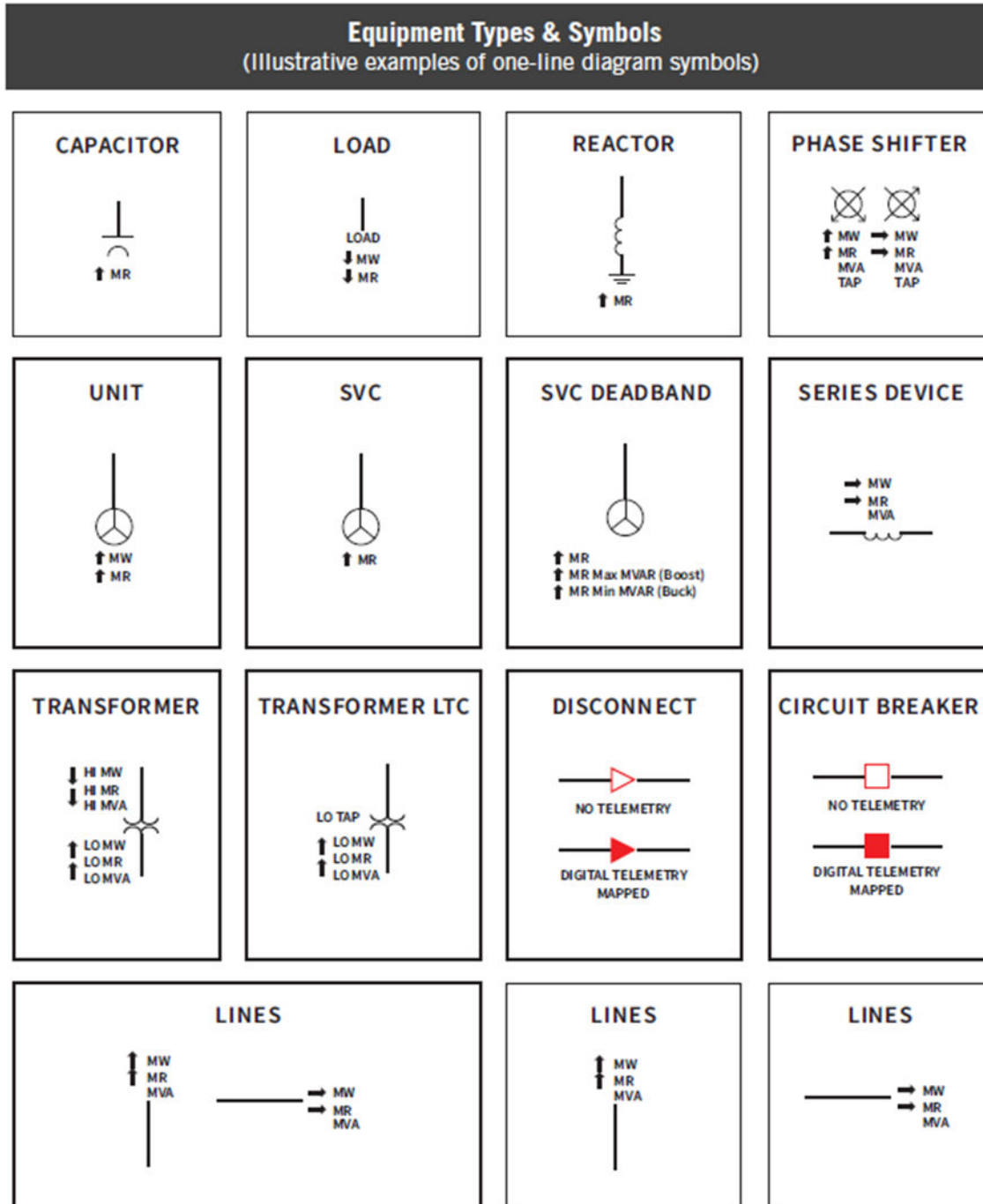

Exhibit 6: One-Line Diagram Symbols

In summary, load flow and engineering data available through eDART TERM and other eDART applications for users is quite extensive. The data has been provided with the primary objective of enhancing each TO's ability to validate models of their respective systems, but the data is available for general purpose use.

When TOs submit data in advance, the one-lines and engineering data provided will afford users the opportunity to validate models prior to transferring the data into production systems. It is incumbent upon TOs to perform the checks as soon as possible after each build. If corrections are required and PJM receives them in a timely fashion, they can be incorporated in the interim builds (March and October), avoiding last minute adaptations and/or scrambles to correct problems.

4.4 Processing Tie-Lines

In addition to the need to provide updates concerning tie-lines to ensure that the correct network connectivity is maintained, tie-line projects also impact other systems such as Generation Control and Settlements. Consequently these projects require additional attention.

Refer to PJM Manual 01, Control Center Requirements for all Tie Line classifications and metering requirements.

PJM TOs are responsible for working with PJM planners to identify new tie-lines and/or changes to existing tie-lines as part of the RTEP. All tie-line projects are to be documented in RTEP (see M-14B).

When submitting EMS model flag in the modifications, TOs are also required to clearly identify projects impacting tie-lines using the eDART Network Model request. The Network Model Request should include an interconnection one-line clearly depicting line ownership and operational/revenue metering locations (see Manual 01, Attachment D: Tie Line Meter Placement and Telemetry). When planning outages to the new facilities into service, TOs are required to report the tie-line change to the PJM SOS-T as part of their regularly scheduled monthly meetings. These reports are to be scheduled at least 60-90 days prior to cut-in (see Exhibit 7: Tie Line Update Timeline) and should include references describing and/or itemizing the:

- project stakeholders
- explanation of impact on existing tie-line arrangements
- construction taking place
- cut-in schedule and outage tickets
- metering locations
- telemetry lists
- equipment ratings
- status of legal documents required to approve the tie-line modification
- EMS modeling parameters, topology, names
- Ownership demarcations

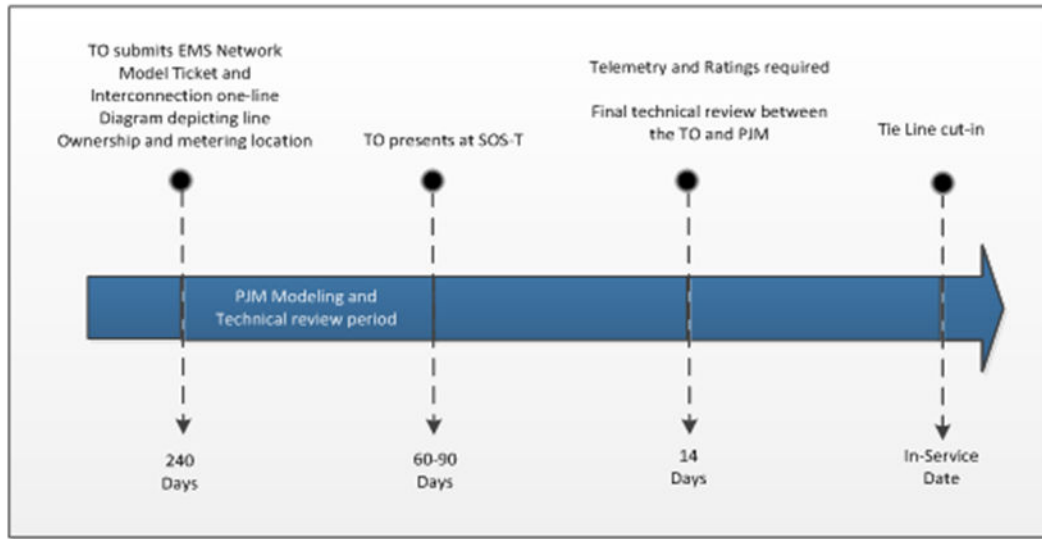

Exhibit 7: Tie Line Update Timeline

See Manual 14-C’s Section 6.1.6 and the discussion concerning Exhibit 3 - Tie Line process actions which discusses the data flow of information related to tie line facilities.

Tie Line information should be posted by TO staffs by completing the form at the PJM web site: <https://www.pjm.com/about-pjm/member-services/tie-lines>.

4.5 Cut-ins and Contingencies

PJM one-lines and models are created to simulate both pre- and post- construction configurations. Consequently, the substations impacted by construction cut-ins must be evaluated and configured accordingly.

Provided projects involving re-configurations, replacements, and/or new construction projects are received from TOs and processed by PJM at least six (6) months in advance of the in-service date, the equipment to be cut in will appear in eDART. Consequently, TO outage schedulers will then be able to schedule outages to support the cut-in of this new equipment. In addition, the TO will be able to submit ratings for the new equipment in TERM, as well as work with PJM staff members to link new telemetry points to support the model changes. In some cases, construction will require more than the usual six (6) months lead time. In that event, PJM will work with the user to model the new configuration 12 to 18 months in advance, depending upon the circumstances. See Exhibit 3 for Network Model Data Submission & Model Validation Timeline.

eDART Outage Ticket Cut-in Flags

It is important for TO staff to use the eDART Transmission Outage Ticket ‘Cut-in’ flag to identify when new equipment or a new configuration is going in service. TO outage schedulers should simply check the ‘Cut-in’ flag on the eDART Transmission Outage Ticket form when scheduling outages that will result in a reconfiguration of the electric system.

By setting the cut-in flag on a transmission eDART outage ticket, the appropriate stakeholders are notified that an outage ticket will result in the need to make model adjustments.

Consequently, setting the flag is very important to ensure that model changes are implemented in a timely manner. See Exhibit 8 eDART Outage Ticket with Cut-in Flag below.

Review/Revise Transmission Ticket

User: **USERA** Company: **Company A** Status: **Received** Ticket ID: **111111**

Company Ticket ID: 23023 RTEP Queue #:

Ticket Start		Ticket End		Switch Date	
09/26/2014	22:00	05/31/2015	23:00	09/26/2014	22:00
<small>Date (mm/dd/yy)</small>	<small>Hour (hh:24.m)</small>	<small>Date (mm/dd/yy)</small>	<small>Hour (hh:24.m)</small>	<small>Date (mm/dd/yy)</small>	<small>Hour (hh:24.m)</small>

[Change Dates](#)

Location/Description of Work (4000 char. max) A-1111 reconductor	Information/Hotline Work <input type="checkbox"/> Emergency <input type="checkbox"/> Vegetation Trip <input checked="" type="checkbox"/> Cut In <input type="checkbox"/> Direct Billing <input type="checkbox"/> Direct Billing Decline Potentially Incomplete: No Congestion Expected: No Submitted On-Time: Yes Market Sensitive: No Automatic Re-Close: No Mitigated: N/A	Cause Add SF-6 Gas C.B. Overhaul C.B. Replacement CB Maintenance Cable Repair Contingency Planning <input checked="" type="checkbox"/> Cut-in Disconnect/Ground Sw. Maintenance Doble Test Emergency Excludable Outage External Fire on Equipment/in Vicinity Gas/Oil Testing/Replacement High System Voltage	Ticket History <table border="1" style="width: 100%; border-collapse: collapse;"> <thead> <tr> <th></th> <th>Time Stamp</th> <th>Usr. Name</th> </tr> </thead> <tbody> <tr> <td>Submitted</td> <td>11/11/2011 11:45</td> <td>USR1234</td> </tr> <tr> <td>Received</td> <td>06/27/2014 15:22</td> <td>USERA</td> </tr> <tr> <td>Approval</td> <td></td> <td></td> </tr> <tr> <td>Latest Revision</td> <td>06/26/2014 13:29</td> <td>usr12345</td> </tr> </tbody> </table>		Time Stamp	Usr. Name	Submitted	11/11/2011 11:45	USR1234	Received	06/27/2014 15:22	USERA	Approval			Latest Revision	06/26/2014 13:29	usr12345
	Time Stamp	Usr. Name																
Submitted	11/11/2011 11:45	USR1234																
Received	06/27/2014 15:22	USERA																
Approval																		
Latest Revision	06/26/2014 13:29	usr12345																

Outage Type: Continuous	Availability: Duration	Planned: <input type="text"/>	Restoration Plan Review Needed: N/A
Type: <input type="text"/>	Station Name: <input type="text"/>	Voltage: <input type="text"/>	Operational: <input type="text"/>

Print Version Date Time Log History Log Notifications Log Cancel Ticket Duplicate Ticket View Conflicts Gen Off Conflicts

Tier 1 Tier 2 Tier 3
Station Equip. Submit Form Refresh System Impacts Gen. Outage Lookup Comments Log NERC-TADS Reports Files Restoration Plan Review Main Menu

Primary	Status	Include	Type	Station Name	Voltage	Equipment Name	Start Date	Start Hour	End Date	End Hour
<input checked="" type="radio"/>	O	Yes	LINE	STATION 1	138 KV	STATION 1 - STATION 2	09/26/2014	22:00	05/31/2015	23:00
<input type="radio"/>	O	Yes	BRKR	STATION 2	138 KV	STATION 2 DUM STAT1 DIS	09/26/2014	22:00	05/31/2015	23:00
<input type="radio"/>	O	Yes	BRKR	STATION 1	138 KV	STATION 1 A-1111-1 DIS	09/26/2014	22:00	05/31/2015	23:00

Exhibit 8: eDART Outage Ticket with Cut-in Flag

Dummy switches to Model New Facilities

Exhibit 9 below illustrates the use of dummy switches at PJM for dual modeling of pre- and post-construction configurations to support model changes. These adjustments are achieved when PJM staff members alter the status of 'dummy' switches, revising the configuration to represent the new arrangements. New equipment is modeled as connected through open dummy switches. Upon cut-in, the switches are closed and the retired/replaced facilities are then disconnected by opening the dummy switches which were closed initially.

Revision: 22, Effective Date: 10/25/2022 PJM © 2022

53

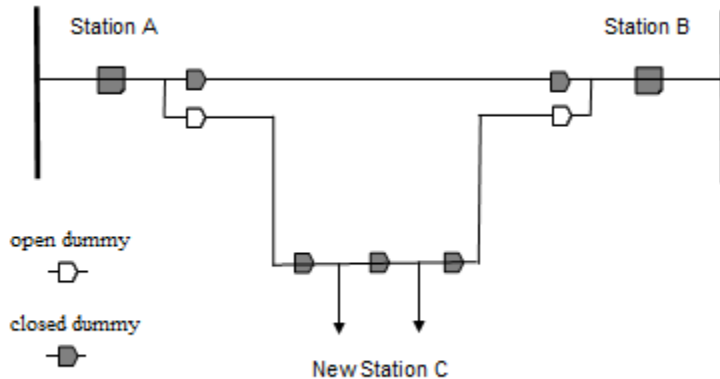

Exhibit 9: Dummy Switches to model new facilities pre- and post-construction

Cut-in Reports

PJM also uses the 'Cut-in' flag to generate weekly reports to help identify when model modifications may be required and verifies that necessary supporting data such as ratings and telemetry are in place. PJM will also ensure that the necessary model modifications are implemented in a timely fashion.

To facilitate the Cut-in process, PJM will publish a weekly list of scheduled outages in eDART that have the Cut-in flag set. The reports include a six (6)-week look-ahead of all outages tickets that have the Cut-in flag set. See Exhibit 10 below.

TOs can filter the information for their individual needs. TOs are expected to review the data for accuracy and begin assembling and submitting necessary ratings data, ensuring that telemetry is provided to support the new configuration. PJM staff members also review this data. Each TO must respond back to PJM within three (3) business days either agreeing that the information is correct or with changes that have been made via eDART.

CUT-IN FLAG REPORT FROM 9/6/2014 to 9/23/2014									
Ticket	TO	Station & Equipment	Volt	Start	End	Type	On Time	Description	
556748	GDF	LONTTOPL KNQPEAST CB 500 KV	500 KV	9/6/14 7:00	9/23/14 16:00	Continuous	Yes	This is part of RTEP project XT250 to rebuild LONTTOPL-KNQPUEHA.	
556748	GDF	LONTTOPL-KNQPUEHA LAC-SUS 500 KV	500 KV						
556748	GDF	LONTTOPL KNQPWEST CB 500 KV	500 KV						
556748	GDF	KNQPUEHA NPCK CB 500 KV	500 KV						
556748	GDF	KNQPUEHA NPCK2TIE CB 500 KV	500 KV						
498073	SCMED	CANTDNTY H452 CB 230 KV	230 KV	1/6/14 14:00	9/25/14 12:00	Continuous	Yes	Wreck and re-build of 230KV line 2017B.	
498073	SCMED	CANTDNTY TX3 XFORMER 230 KV	230 KV						
498073	SCMED	CANTDNTY H352 CB 230 KV	230 KV						
498073	SCMED	CANTDNTY-HARRIERD 2017B 230 KV	230 KV						
498073	SCMED	CANTDNTY H354 DIS 230 KV	230 KV						
498073	SCMED	CANTDNTY L452 CB 115 KV	115 KV						
498073	SCMED	HARRIERD 201786 DIS 230 KV	230 KV						
515466	AEL	WATERFAL-TOWNROCK 118981-2 115 KV	115 KV	9/4/14 9:00	9/26/14 12:00	Continuous	Yes	69/115kv Transformer 2 at Waterfall out service for replacement	
515466	AEL	WATERFAL WFTR_2_AB CB 69 KV	69 KV						
515466	AEL	WATERFAL WFTR_2_ CB 115 KV	115 KV						
515466	AEL	WATERFAL 2 XFORMER 115 KV	115 KV						
515468	AEL	ACERRECA AB5567 CB 138 KV	138 KV	9/17/14 18:00	9/19/14 21:00	Continuous	No	AB5567 NEEDS TO COME OUT TO INSTALL NEW BREAKER	
548804	FCIT	48 TUHOD-1916 1916 2 138 KV	138 KV	9/22/14 6:00	9/26/14 21:00	Daily - Weekends Only	Yes		Need to install switch structures at WINE EAST terminal.
548804	FCIT	892 TUHO 1916 CS DIS 138 KV	138 KV						
548804	FCIT	46 WINEEG 38L4916 CB 138 KV	138 KV						
548804	FCIT	48 TUHOD-1916 1916 2 138 KV	138 KV	9/17/14 18:00	9/19/14 21:00				
548804	FCIT	Close 984 RANDE 38BT5-6 CB 138 KV	138 KV						
548804	FCIT	Close 296 GTUN BT1-2 CB DIS 138 KV	138 KV	9/22/14 6:00	9/26/14 21:00				
548804	FCIT	48 TUHOD LK 38TR77 34 138 KV	138 KV		9/22/14 18:00				
548804	FCIT	294 GURNE 38L1916 CS 138 KV	138 KV	9/17/14 18:00	9/19/14 21:00				
548804	FCIT	48 TUHOD 34TR77 CB 34.5 KV	34.5 KV	9/22/14 6:00	9/22/14 18:00				
548804	FCIT	46 WINEE-4916 4916 1 138 KV	138 KV	9/15/14 6:00	9/19/14 21:00				
548804	FCIT	46 WINEE-4916 4916 1 138 KV	138 KV	9/16/14 15:16	9/26/14 21:00				
548804	FCIT	48 TUHOD 1916 CB CB 138 KV	138 KV	9/17/14 18:00	9/19/14 21:00				

Exhibit 10: Sample Format for 6-Week Look Ahead Cut-in Report

Contingencies

Similarly, contingencies defined in the PJM EMS may need to be altered as system changes occur. Contingency files are re-processed and re-calibrated to align model elements with the contingency definitions as part of the EMS build process. In addition, PJM Power Systems Modeling and Reliability Engineering Department staff members review the contingency lists to ensure that the definitions are modified to reflect protection scheme changes.

4.6 SCADA Mapping

The volume of data to model is extremely large, with some 70,000 SCADA points alone used by PJM. PJM relies on several contributing factors to ensure model accuracy and reliable analytical tools to provide operations support - 24x7x365. To ensure that the online programs solve during widely varying operating conditions, PJM must, and does, rely on automation to detect data inconsistencies and problems, and TO support. Complete point-by-point audits have proven to be time-consuming with extended turn-around times. In addition, the electrical grid is constantly changing and audits have shown to become out-of-date before they can be

completed, rendering them not only costly, but somewhat ineffective. Consequently, PJM relies upon the inherent capabilities of the SE solution to rigorously and mathematically assess the data/model to reconcile and/or reveal data inconsistencies. The PJM experience is that the SE effectively solves over a wide range of operating conditions, indicating that the model is highly tuned and accurately reflects real-time conditions. Incorrectly mapped status points are revealed through anomaly detection. In addition, problems reported by various staff members and/or TOs are thoroughly investigated and feedback is provided. Adding metering to areas with minimal observability would serve to enhance error detection.

Also see Section 5 of this Manual, Real-Time Application Support, for information about problem solving.

4.7 One-line Life Cycle

PJM's EMS depends primarily upon substation one-line diagrams to provide users with information regarding SCADA and SE data. The diagrams are also designed for easy user reference to calculated residuals which illustrate the difference between the calculated SE values and the corresponding SCADA values.

Most of PJM's EMS one-lines have been, and continue to be, created manually. However, the capability exists to auto-generate one-line diagrams. This feature is typically used as part of a process to enhance large areas of the model when a high volume of one-lines is required. This situation occurs, for instance, during expansion of the RTO and/or when portions of the external model are expanded. Although electrically correct, the auto-generated diagrams are not always as direct and easy to read as are manually created diagrams. Hence, PJM prefers manually creating one-line diagrams to support changes to an existing substation and/or creation of a new substation in the model.

PJM one-lines that reflect the modifications to the model are created during the test or soak period prior to implementing the new data base in the production EMS. The new and modified diagrams are converted automatically to SVG format immediately after the new build is completed. The new one-lines are integrated into the eDART Data Collection/Model Update Function. The TO is required to review the new and updated drawings for their areas to ensure that the changes submitted are accurately illustrated, capable of representing both the pre- and post- construction models. Recalling that model changes are to include construction projects at least six (6) months in advance, there should be adequate time to correct and adjust models if necessary. To provide an opportunity to make necessary adjustments, it is important that problems and modifications be reported as soon as possible.

4.8 Data Management Subcommittee (DMS)

The DMS was re-formed in 2005 to create a forum for PJM TOs to provide input and feedback to the PJM EMS model update process. The DMS meets up to four (4) times per year and as needed, with typically one (1) meeting in person but are flexible in keeping remote options available. TO members seeking placement on DMS complete and submit a Roster Update Form and CEII Request Form available on www.pjm.com. The parent committee to which the DMS reports is the OC. Once the member is successfully added to the roster and CEII clearance is approved, they are added to the DMS e-mail distribution list and, pending confirmation of qualifying actions, provided access to the DMS Workplace on pjm.com.

DMS meetings serve as a forum to exchange information about models, gain familiarity with existing or future PJM systems, share important training information, and learn from the experiences of each participating organization. Due to the technical nature of discussions and sharing of proprietary and confidential data, these meetings are only open to PJM personnel and those listed on the DMS roster. All confidential data and information is shared with members on the DMS SharePoint website and the DMS Workplace on pjm.com.

For more information regarding the DMS, including Charter and Roster, please visit the PJM.com DMS page: <http://pjm.com/committees-and-groups/subcommittees/dms.aspx>

4.8.1 DMS SharePoint Website

A DMS SharePoint website was created for the purpose of uploading and exchanging confidential model-related information among DMS Members. Members must have an active, signed model sharing confidentiality Non-Disclosure Agreement (NDA) available in eDART to gain and maintain access to the DMS SharePoint website. Users send their pjm.com username to DMS_Officers@pjm.com to request access to the SharePoint site. Once access is granted, users can access the DMS SharePoint site with their PJM.com username/password.

Data Sharing of DMS SharePoint for members is encouraged and includes:

- System Maps, Switching maps, and Single lines
- Internal Equipment Model dumps - PJM Footprint region.
- CIM
- ICCP Telemetry files

Section 5: Real-time Application Support

Welcome to the Real-Time Application Support section of the **PJM Manual for EMS Model Updates and Quality Assurance**. In this section, you will find information on the following topics:

- Real-time Analysis
- State Estimator (SE) Solution Quality and ICCP Links
- Real-time Contingency Analysis (RTCA) and Solution Quality
- New EMS Models Validation and Benchmarking
- Quality of Analysis Used in Real-time Assessments

5.1 Real-time Analysis

PJM's SE runs on a one (1) minute periodic trigger. The results of the SE solution are presented to operators through substation one-lines. The SE serves two (2) major functions:

1. It estimates data to ensure a consistent representation of the current grid which serves as a base condition for further analyses such as Security Analysis (SA) and
2. It provides estimated, near real-time data to PJM system operators to eliminate metering inconsistencies and inaccuracies (for example, multiple voltage measurements at a bus are reconciled, etc.).

Note:

SA corresponds to the PJM tool used for Contingency Analysis referred to by the industry term Real Time Contingency Analysis (RTCA)

Several factors impact the real-time applications and the value of these tools:

- The model must accurately represent the electrical grid to be analyzed for security assessments. The model must also take into consideration the impact of tightly-coupled portions of adjacent electric systems (a/k/a Wide Area View (WAV)). To support Reliability Coordinator functions, the PJM model must accurately represent the RTO 'footprint' as well as components in adjacent systems.
- At all times, the model must accurately represent maintenance conditions and/or any unusual operating arrangements which alter the grid and resulting flows.
- The solution must be achieved quickly and reliably (good numerical stability over varying operating conditions) to provide operators with high-quality, near real-time information. To do this, the PJM model is intentionally kept to the minimum size necessary. PJM's SE and SA programs are initiated every minute of the day. Under normal conditions, SE and SA results are obtained within one minute.

5.2 State Estimator (SE) Solution Quality and ICCP Links

The PJM SE is triggered to execute every minute. PJM maintains a record of SE convergence to measure availability. SE convergence is calculated monthly as number of converged solutions divided by the total number of attempted executions of the program (converged + non-converged solutions). The SE Convergence percentage is an overall picture of how robust the solution algorithm and model is, but the number should be used carefully. Historical convergence statistics illustrate that the model is very well-conditioned, solving in well over 98% of the attempted executions.

In addition, the TOA-AC Metrics report records performance statistics representing TO performance on EMS, SE Convergence and data (into their system and into PJM system). ICCP links, as well as links to generating plants, are monitored by the PJM EMS. Alarms are generated whenever abnormal conditions occur.

SE is dependent upon the timely receipt of data from GOs as well as TOs to provide digital status and analog telemetry. This data is primarily provided via ICCP links for TOs and GOs. For some small generating companies, the data is provided via DNP protocol. A link outage report is maintained for all PJM links. When a link is down, the incoming data is obviously bad so it is important to keep the links functioning and providing good quality data.

As part of SE solution tuning, EMS support staff members routinely:

- Review anomalies and/or residuals
- Analyze performance indicators such as
 - o the number of iterations to converge to a solution
 - o assessment of metering or modeling issues
- Investigate all problems reported by operators and reliability engineers

PJM Operators and Reliability Engineering staff is trained to handle some problems directly. If they cannot, during normal business hours back-office support staff will be called upon to assist. If off-hours problems occur then PJM has an on-call list to provide support. If the problems are determined to be on the TO or GO end, contact lists have been established to help resolve the problem as quickly as possible.

Restoring SE is afforded immediate priority in accordance with NERC requirements.

Any non-convergence problems are reported and resolved as quickly as possible. Operators and on-shift Reliability Engineers are trained as the first line of defense with back-office support and on-call staff available for higher level support. Historically, non-convergence problems are most likely to be caused by problems with TOs and GOs-submitted SCADA data. Therefore, it is critical for member companies to provide dependable SCADA data to prevent the creation of significant data skews. If the problems are determined to be on the TO or GO end, contact lists have been established to help resolve the problem as quickly as possible.

In addition, upon request, PJM staff will exchange results of the PJM SE with representatives of the various TOs to compare PJM and TO SE results and provide a dump of the SE model in PSS/e format for the TOs to review.

Results from the PJM SE may be compared to the SE results produced by the TO and/or other company. If there are differences which cannot be readily explained, PJM support staff members will work with TO representatives to take appropriate action.

5.3 Real-time Contingency Analysis (RTCA) and Solution Quality

PJM's SA program (used for RTCA) is triggered immediately upon completion of a convergent SE. SA simulates thousands of outage scenarios (contingencies) with full AC analysis nearly every minute of the day. In addition, there are contingencies defined to simulate special circumstances such as Maximum Credible disturbances. These are run on an as-needed basis. Both the real-time sequence and the study package are able to execute these contingencies for a thorough analysis of the behavior of the electrical system in response to the various scenarios. The vendor's software makes adding new contingencies fairly routine, and each element that is to be included in a given contingency must be defined. The contingencies are originally prepared based on available system one-lines and usually depict the equipment which is opened by protective relaying (breaker operation), unless specific operating procedures/orders support modeling additional switching. The individual elements of a contingency are validated against equipment defined in the PJM EMS model. Any reported errors are corrected by PJM operators, Reliability Engineers, and/or back-office support staff. Contingencies affected or required by equipment updates/configuration changes, etc., are usually implemented by back-office support staff members prior to the completion of construction.

5.3.1 RTCA Solution Quality

PJM staff members monitor the SA program (used for RTCA) similar to the SE application. If non-convergent simulations occur, the problems are examined and resolved through appropriate means. If the SA aborts, an alarm is generated and shown to the operators. In addition, the online programs indicate if any of the contingencies simulated do not solve. If the dispatchers cannot resolve the problem, problem resolution is escalated to on-shift reliability engineers and, if the problem is still unresolved, support personnel are called. PJM's Study Real-Time Maintenance package is used to determine if the problem can be repeated and as a de-bugging tool. PJM staff members seek to understand the reason for all non-converged solutions because any contingency which does not produce results may be an indication that the occurrence of the event will be harmful to the overall system.

As with the SE, PJM also relies upon the daily experiences of dispatchers and reliability engineers to validate that the SA results. Dispatchers and Reliability Engineers are in frequent contact with TOs and adjacent companies. Results from the PJM SA are compared to the SA results produced by the TO and/or other company. If there are differences which cannot be readily explained, support personnel are called to analyze the situation. If no explanation is apparent, PJM support staff work with TO representatives to compare results and models until any the differences can be explained. Depending upon the results of the investigation, appropriate actions are taken.

During normal business hours, support staff members are available. Members of the PJM EMS support staff coordinate their availability to provide call-in support during off-normal business hours. Restoring SA is afforded immediate priority.

5.4 New EMS Models Validation and Benchmarking

Prior to placing a new model into production, PJM staff complete a rigorous ‘soak’ test. The new EMS model is implemented on a test system and a complete set of the SCADA data linked to the current real-time model is interfaced with the new model. The soak test spans up to a four (4) week period, and is designed to ensure that the model will produce stable and accurate solutions over a wide array of operating conditions. Results from the test system are compared to results from the production model to determine if they are consistent. As inconsistencies or model errors associated with either SE or SA results are uncovered, adjustments and corrections are made to the new model (see Section 5.3 RTCA Solution Quality).

For a two (2) day period prior to the scheduled transfer of the new model to the production system, PJM uses the following criteria to determine readiness for installing the new model into production:

- No less than 98% of SE solutions converge
- No more than 10 consecutive non-converged solutions
- Average number of solution iterations is <20
- ≤25 bad data points (<.05% of ~ 51,000 kV, MW, MVAR & Tap analogs)
- Pre- and post-build SE Bad Data differs by no more than 2 existing locations

Note that if any unanticipated conditions occur which adversely impact the results listed above, PJM will analyze the situation before proceeding with the build. If it is deemed prudent to proceed with the build, documentation will be prepared explaining the circumstances.

5.5 Quality of Analysis Used in Real-Time Assessments

The Member TO shall implement an Operating Process or Operating Procedure to address the quality of analysis used in its Real-time Assessments (see TOP-010 R3). The Operating Process or Operating Procedure shall include:

- Criteria for evaluating the quality of analysis used in its Real-time Assessments
- Provisions to indicate the quality of analysis used in its Real-time Assessments to PJM
- Actions to address analysis quality issues affecting its Real-time Assessments

Member TOs performing Real-time Assessments shall have periodic monitoring of quality of analysis used in their Real-time Assessments.⁸ Each Member TO-defined solution quality criteria for Real-time Assessment shall have at least a frequency of 30 minutes, consistent with the current NERC requirement for conducting a Real-time Assessment.⁹

The Member TO shall notify PJM when:

⁸ See NERC Standard TOP-010, Supplemental Material – Requirement R3.

⁹ See NERC Standard IRO-008-2, R4: <http://www.nerc.com/files/iro-008-2.pdf> and the related NERC Standard TOP-001 R13 and R14: <http://www.nerc.com/pa/Stand/Reliability%20Standards/TOP-001-3.pdf>

- Analysis quality issues affecting its Real-time Assessment have existed for 30 minutes. Notification shall be verbally communicated to PJM Control Room (“Real-time Assessment Notification”). Notification should be made within 15 minutes of Member TO recognition that analysis quality issues affecting the Member TO’s Real-time Assessment have existed for 30 minutes.
- Real-time Assessment quality is back to normal. Notification shall be verbally communicated to PJM Control Room (“Real-time Assessment Recovered”). Notification should be made within 15 minutes of Member TO’s determination that the Real-time Assessment quality is back to normal.

Appendix A: TERM Equipment Ratings Update Process

What is TERM?

Transmission Equipment Rating Monitor (TERM) is an eDART application that serves as a front-end ratings repository that can be accessed at:

<https://edart.pjm.com/mui/index.htm>. TERM application can be reached via one of the buttons on the bottom left-hand side.

Ratings are submitted to TERM in two ways via:

- 1) TERM user interface (UI) in eDART 2) EMS/TERM Bridge

Note:

Requirements for which facilities require ratings are outlined in Appendix C: List of Monitored Priorities

Users submit ratings change tickets via the eDART UI and PJM staff then reviews the submissions for approval and/or implementation. TERM tickets submitted via eDART can be classified as either 'Permanent' or 'Temporary.' Users entering a permanent ticket are required to enter an estimated state date but not an estimated end date. For Temporary tickets, however, users must enter both the estimated state date and estimated end date. Neither the estimated start date nor estimated end date automatically trigger any changes in EMS ratings. However, if immediate action is required, PJM operators/REs have the ability to enter ratings data directly into EMS (EMS/TERM Bridge), outside of TERM.

PJM's EMS performs the actual limit checking. Data is transferred manually from TERM to the EMS where automated programs continuously check that all EMS ratings data is consistent with the corresponding TERM data. Periodic checks run each day (0600 and 1800 hours) to verify that the ratings in EMS and in TERM are consistent. When differences are found, the system automatically generates TERM tickets to match the EMS ratings. A Temporary TERM ticket is created with a status of 'Implemented w/o Approval' when the EMS data and TERM data are inconsistent to reflect the EMS data in TERM. No ratings are automatically updated in EMS.

As TERM tickets are processed, the status of the ticket changes. Once the start date/time approaches and necessary approvals are gathered, PJM staff changes the status of the TERM ticket to 'Implemented', and manually processes the ratings to the PJM EMS database. Once the EMS database is updated and EMS to TERM bridge runs, the "Actual Start" field gets populated with the date and time the ticket implementation is completed.

The Exhibit below illustrates TERM Ticket Submission Process when ticket is initiated by both the TO and by PJM.

TERM Ticket Submission Process

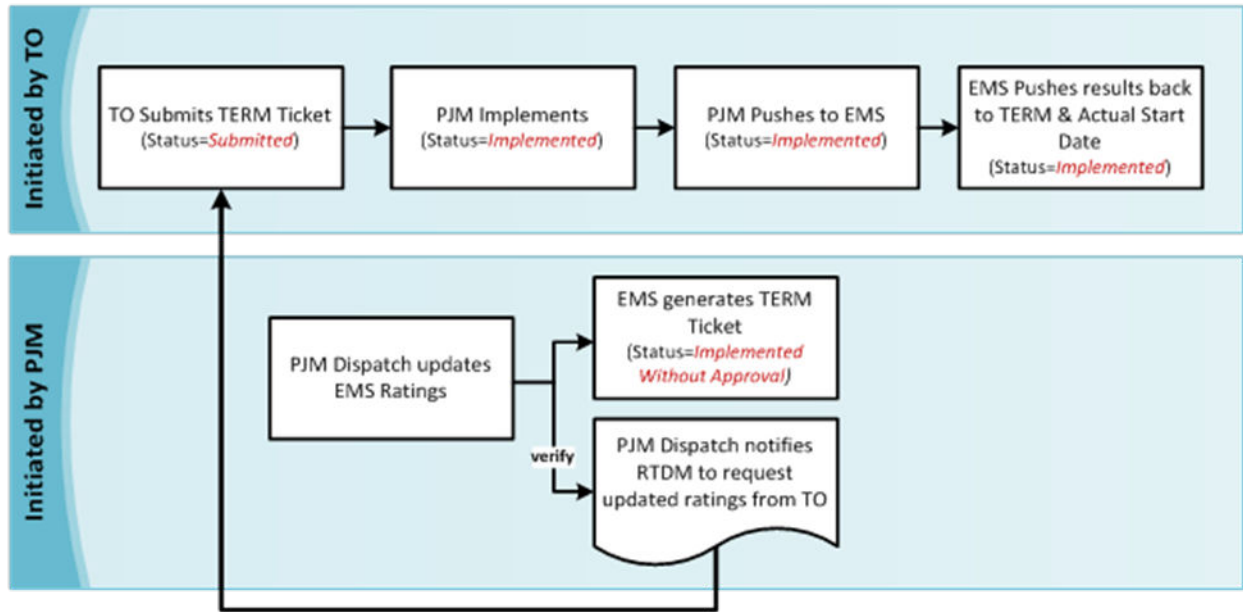

Exhibit 11: TERM Ticket Submission Process

When a new Permanent ticket replaces existing data, the previous Permanent ticket is changed to a status of 'Completed' and any Temporary tickets are flagged as 'Restored'.

When a new Temporary ticket replaces an existing Temporary ticket, the existing Permanent ticket continues to exist in 'Implemented' status but the previous Temporary ticket is changed to a status of 'Restored'.

Tickets automatically created by the EMS/TERM Bridge are always classified as Temporary with the Estimated End Date as Start + 1 Month. The system then assigns a status of **'Implemented without Approval'**, and the ratings remain in effect until a new ticket is either processed by PJM staff based on data submitted through the UI, or a subsequent check of the EMS finds that the TERM and EMS ratings data disagree.

See the Exhibit below for examples of TERM ticket submissions (Permanent and Temporary) and the resulting status changes.¹⁰

¹⁰ For further detail and information on the TERM application and specific TERM fields, see the eDART Users Guide located on the PJM website at: <https://pjm.com/markets-and-operations/etools/edart.aspx>

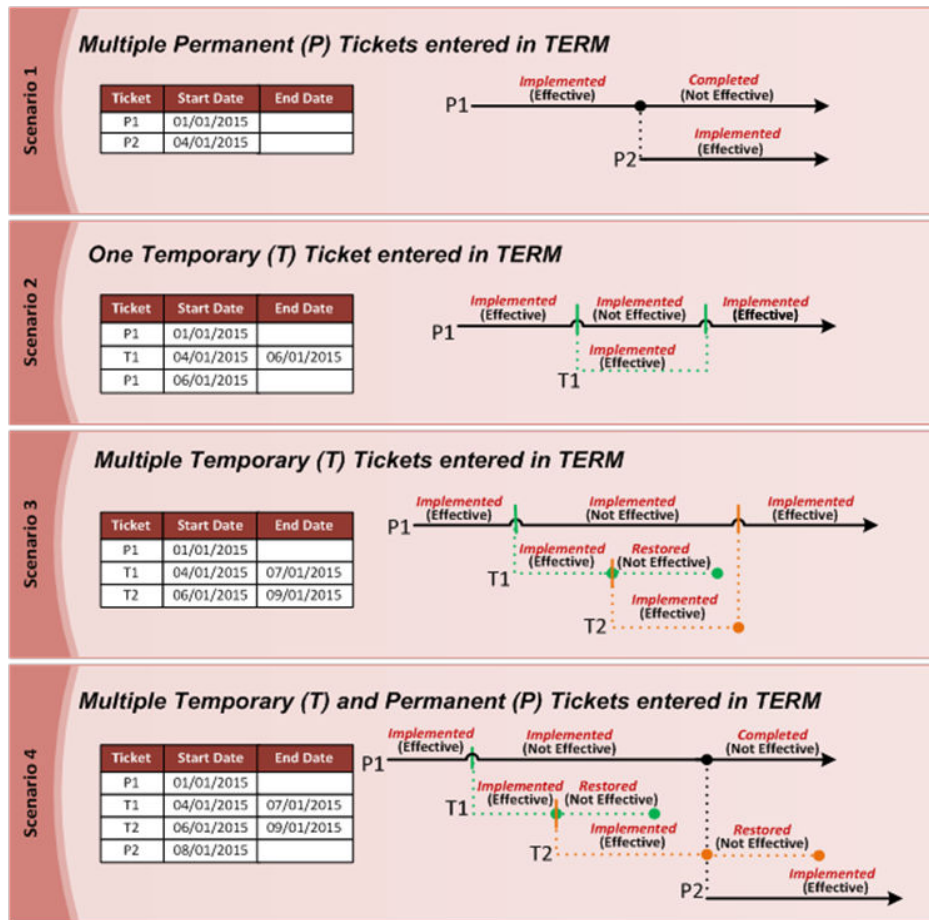

Exhibit 12: Examples of TERM Ticket Status Changes

Submitting TERM Tickets

Only authorized TO staff members can access TERM. See Appendix B for links to access eDART, which includes TERM. TOs are expected to coordinate changes to the PJM EMS Ratings data with changes in their internal EMS.

The TO is required to provide justification for the change and for coding in the field marked 'Reason for the Change'. A reason for the change can be selected from a drop-down menu and users can also manually enter comments. Users are encouraged to make use of the comments field since this information can make the approval process more efficient. TERM also requires users to enter the limiting device for each rating provided. A variety of different types of limits can be viewed and selected from the drop-down menu provided (e.g., conductor, bus, wave trap, switch, etc.).

PJM default conventions for modeling ratings:

- Rate the low-side of 2-winding transformer since metering is usually there
- Rate the high-side of the primary winding of 3-winding transformers
- Never implement ratings on the 1 kV side of 3-winding Transformers

- Rate End A only for internal lines and
- Rate both End A & End B for tie-lines (owner is responsible for data).

Users should note that PJM specifies how the rating sets will be applied in operations in Section 2, Thermal Operating Guidelines in M-03 Transmission Operations.

The TO is responsible for verifying that all data is correct. Ratings change requests should be submitted as early as possible prior to the expected implementation date to allow PJM to review impacts. See Appendix E: Checklist For New Equipment Energization Process for PJM's submission guidelines. It is particularly important to submit changes resulting from new installations with this lead time to ensure that new facilities will be monitored when required.

Furthermore, PJM recognizes that ratings are critical to reliable operations and that some rating changes may not be anticipated by the TO. Consequently, exceptions to this policy can be accommodated upon request by the TO. If PJM agrees that the changes are reasonable and necessary, the changes will be processed as soon as practical to coincide with the Start Date entered by the user. Users should note that the requested Start Date does not automatically trigger implementation of ratings changes. Users should personally contact TERMTickets@pjm.com if it is imperative to expedite ratings implementation.

Checking the Monitored Equipment Priority Flag in EMS¹¹

Since equipment can be monitored for a number of different reasons, it is necessary to categorize components of the overall electric system monitoring effort. The active Monitored Priority (Congestion Management Priority) of a given facility is available in TERM while submitting or reviewing tickets and ratings. TOs should check and verify the Monitored Priority of the equipment while submitting a TERM ticket, and only submit ratings for facilities where ratings are required based on the Monitored Priority assigned. The various types of monitored equipment are identified in Appendix C, Exhibit 15.

Processing Tie Line Ratings

Ratings changes impacting tie-lines are communicated to both owners and/or the responsible NERC Security Coordinator for the facility to ensure consistent application. Ratings for each end of the facility should reflect the owning company's ratings of the facility as the PJM EMS has the capability of selecting the most limiting ratings from either end of the tie-line. PJM will coordinate implementation of tie-line ratings to ensure that owners of both ends of the line have entered the correct information.

Processing Permanent TERM Tickets

Real-Time Data Management (RTDM) staff members are responsible for evaluating rating change requests. The TERM queue is checked daily for new entries during normal work days by PJM staff. Ratings are typically checked for the following:

¹¹ Note that PJM's implementation of the BES definition requirements are discussed in Appendix C of this manual.

- Ratings are expected to decrease as the temperature index goes up (valid exceptions exist, e.g., differences caused by winter/summer load curves used to derive transformer ratings).
- The same Emergency ratings will populate both the Short-term and Long-term Emergency ratings unless the facility has an approved operating procedure justifying differences between these ratings (e.g., Post-contingency facilities).
- Long-term Emergency ratings are expected, but not required to be higher than Normal Ratings.
- Long Term Emergency ratings are expected to be at least 3% lower than Load Dump ratings. See M-03, Section 2.1.1 Facility Ratings for more information.

If the reason for the change is not clear, or there are any questions about the requested change, TOs will be required to provide additional justification or information. A comments field is provided, and PJM highly encourages the TOs to use this field to provide more information to expedite the TERM ticket review process.

TOs can view TERM to learn the status of tickets or view the ticket to learn the 'Actual Start Date'. The Actual Start Date indicates when the ratings became active in the PJM EMS. If there is no Actual Start Date listed, the change is not active in PJM's EMS.

After implementing the change, RTDM circulates a notice to PJM Dispatch, Operations Planning, Transmission Planning, and Forward Market Operations staff members informing all concerned that a ratings change was implemented.

Processing Tie Line Ratings

Ratings changes impacting tie-lines are communicated to both owners and/or the responsible NERC Security Coordinator for the facility to ensure consistent application. Ratings for each end of the facility should reflect the owning company's ratings of the facility as the PJM EMS has the capability of selecting the most limiting ratings from either end of the tie-line. PJM will coordinate implementation of tie-line ratings to ensure that owners of both ends of the line have entered the correct information.

Temporary Rating Changes

Temporary ratings changes on a facility can occur due to several reasons, such as equipment failure, system conditions, or planned outages. In these situations, TOs must enter ratings data in TERM by submitting a temporary TERM ticket, and provide an estimated End Date/Time. Recognizing that these ratings may impact real-time operations, these tickets will be processed as close to the start date/time as possible.

Temporary ratings changes can be planned or immediate. If an immediate (emergency) rating change is needed,

PJM operators can, at their discretion, implement temporary ratings changes directly into the EMS before the temporary TERM ticket is implemented. However, a temporary ticket must still be entered by the TO by the next business day with more details.

The procedure below discusses submitting and implementing temporary ratings:

1. If the temporary ratings change is planned and is in the future:
 - a. TO staff should create a temporary TERM ticket with an estimated start and end date, and enter the reasons and details for temporary ratings in the comments section.
 - b. The temporary ticket will be reviewed by PJM staff and implemented as close to the estimated start date/time as possible.

1. If the temporary ratings change is immediate and urgent:
 - a. During business hours, TO staff should:
 - i. Alert PJM Dispatch to the ratings changes.
 - 1) PJM Dispatch will manually implement the necessary changes directly into the EMS until the TERM ticket is implemented.
 - 2) The manual ratings change will automatically be sent to TERM and a placeholder ticket will be created under the user PROC_BRIDGE.
 - ii. Submit the temporary TERM ticket in TERM with the reasons and details for temporary ratings in the comments section.
 - iii. Contact RTDM staff to process as soon as possible to expedite
 - b. Outside of business hours, TO staff should:
 - i. Alert PJM Dispatch to the ratings changes.
 - 1) PJM Dispatch will manually implement the necessary changes directly into EMS until the TERM ticket is implemented.
 - 2) This manual ratings change will automatically be sent to TERM and a placeholder ticket will be created under the user PROC_BRIDGE.
 - ii. Submit the temporary TERM ticket by the next business day with the reasons and details for temporary ratings in the comments section.
 - iii. Contact RTDM staff to process as soon as possible to expedite

TOs are responsible for notifying PJM when an active temporary ticket should end, and permanent ratings should be re-implemented. Note that the temporary TERM tickets do NOT automatically restore when the Estimated End Date is reached.

The procedure below discusses restoring temporary ratings:

To restore facility to its permanent ratings, the TO should:

1. Alert PJM Dispatch to the ratings changes back to permanent ratings.

- a. PJM Dispatch will manually implement the necessary changes directly into the EMS in real-time until the permanent TERM ticket is re-implemented.
- b. The rating change will automatically be sent to TERM and a placeholder ticket will be created under the user PROC_BRIDGE.
2. Notify PJM staff that the permanent ratings should be re-implemented. This
 - a. Open the current 'Implemented' or 'Implemented w/o Approval' Temporary ticket in TERM and click 'Restore to Permanent
 - b. Contact RTDM staff to expedite
3. a. During off-shift hours, the TO should:
 - i. Contact PJM Dispatch
 - 1) PJM Dispatch will implement the necessary changes directly in EMS
 - 2) PJM Dispatch will re-enter appropriate ratings data if the temperature set for TO is changed at PJM
 - b. Submit a temporary ticket in TERM and
 - c. Contact RTDM staff during normal business hours to expedite

Bulk Ratings Changes

Ratings are expected to be fairly constant over time with ratings revisions generally implemented on an exception basis. However, PJM will work with TOs to develop a plan for implementing changes impacting large numbers of facilities if required.

TERM has been expanded to provide the ability for PJM staff to support bulk ratings uploads. To support this type of effort, TOs are required to provide spreadsheets denoting temperature-indexed ratings data for Normal, Long-Term Emergency, Short-Term Emergency and Load Dump ratings. Other required data includes the limitation (using an index of approved limitations) associated with the corresponding ratings (e.g., conductor, relay, etc.). The spreadsheets must also provide the PJM EMS B3 Text name to link the equipment to the existing PJM EMS model. Refer to the TERM-Bulk Uploads section in the eDART User Guide for details on submission of Bulk Rating files, including limitations data at: <http://www.pjm.com/~media/etools/edart/edart-user-guide.ashx>.

See Exhibit 14 for a sample TERM Bulk Upload file.

TEMPERATURE_VALUE	DAY_NIGHT	NORMAL	LONG_TERM	SHORT_TERM	LOAD_DUMP	B3_TEXT	PSEE_STATION_A	PSEE_STATION_B	PSEE_ID	VOLTAGE	END_VALUE	Norm Limiting	LTE Limiting	STE Limiting	LD Limiting
95	day	9999	9999	9999	9999	EQUIPMENT NAME	STATIONA 138.00	STATIONB 138.00	1	138	END A	80	80	80	80
95	night	9999	9999	9999	9999	EQUIPMENT NAME	STATIONA 138.01	STATIONB 138.01	1	138	END A	80	80	80	80
86	day	9999	9999	9999	9999	EQUIPMENT NAME	STATIONA 138.02	STATIONB 138.02	1	138	END A	80	80	80	80
86	night	9999	9999	9999	9999	EQUIPMENT NAME	STATIONA 138.03	STATIONB 138.03	1	138	END A	80	80	80	80
77	day	9999	9999	9999	9999	EQUIPMENT NAME	STATIONA 138.04	STATIONB 138.04	1	138	END A	80	80	80	80
77	night	9999	9999	9999	9999	EQUIPMENT NAME	STATIONA 138.05	STATIONB 138.05	1	138	END A	80	80	80	80
68	day	9999	9999	9999	9999	EQUIPMENT NAME	STATIONA 138.06	STATIONB 138.06	1	138	END A	80	80	80	80
68	night	9999	9999	9999	9999	EQUIPMENT NAME	STATIONA 138.07	STATIONB 138.07	1	138	END A	80	80	80	80
59	day	9999	9999	9999	9999	EQUIPMENT NAME	STATIONA 138.08	STATIONB 138.08	1	138	END A	80	80	80	80
59	night	9999	9999	9999	9999	EQUIPMENT NAME	STATIONA 138.09	STATIONB 138.09	1	138	END A	80	80	80	80
50	day	9999	9999	9999	9999	EQUIPMENT NAME	STATIONA 138.10	STATIONB 138.10	1	138	END A	80	80	80	80
50	night	9999	9999	9999	9999	EQUIPMENT NAME	STATIONA 138.11	STATIONB 138.11	1	138	END A	80	80	80	80
41	day	9999	9999	9999	9999	EQUIPMENT NAME	STATIONA 138.12	STATIONB 138.12	1	138	END A	80	80	80	80
41	night	9999	9999	9999	9999	EQUIPMENT NAME	STATIONA 138.13	STATIONB 138.13	1	138	END A	80	80	80	80
32	day	9999	9999	9999	9999	EQUIPMENT NAME	STATIONA 138.14	STATIONB 138.14	1	138	END A	80	80	80	80
32	night	9999	9999	9999	9999	EQUIPMENT NAME	STATIONA 138.15	STATIONB 138.15	1	138	END A	80	80	80	80

Exhibit 13: Sample TERM Bulk Upload File

PJM staff assigns a group name to identify the bulk file submitted. PJM will perform routine data checks as noted earlier in this section prior to implementation. Once the TO and PJM arrive at an approved working file, a date will be established to implement the data.

Prior to submitting bulk rating file, TO should contact PJM staff to advise of upcoming submission, and mention the desired implementation date. PJM staff will study extent of bulk ratings changes to assess scheduling of bulk rating changes. Files must be submitted a minimum of two (2) weeks before requested implementation date. Exceptions to this timeline may be approved by PJM depending on the volume of changes requested. PJM staff will study extent of bulk ratings changes to assess scheduling of bulk rating changes.

After the bulk ratings file has been processed, individual TERM tickets are automatically created with the same group name, and the tickets are processed and implemented by PJM on the agreed-upon implementation date.

Processing of real-time Dynamic Ratings

Certain features are available in TERM to facilitate the Dynamic Rating strategy discussed in Manual 03 Section 2.1.1.2. After the required SCADA point mapping is performed to configure the dynamic ratings in PJM’s Energy Management System, the TERM application must be configured to properly handle the dynamic rating updates received. First, the dynamic equipment flag must be set in TERM by PJM for the appropriate equipment to be dynamically rated. This will enable the following logic to be performed in real-time:

- When a new dynamic rating is received into the EMS via the EMS datalink (ICCP/DNP), the TERM/EMS bridge will provide this new rating to TERM. Then, the TERM application will automatically close any temporary tickets available for the equipment and then create a new temporary ticket containing these dynamic ratings.

- New temporary tickets for dynamic rating equipment will use the current date and time as the estimated and actual start time.
- The ticket estimated end time will be calculated one month from the start time similar to the other EMS bridge tickets.
- The actual end time will be populated once a new set of ratings come into EMS.

Public Posting of Equipment Ratings

On a daily basis, PJM posts the current effective ratings for equipment in the TERM application that is not deemed market sensitive. The current effective ratings are located on the PJM OASIS Web site at: <http://www.pjm.com/markets-and-operations/etools/oasis/system-information/ratings-information.aspx>. Identifying equipment (e.g., transformers) with a market-sensitive designation indicates that by providing information on it would disclose confidential information about a generator.

Forecasted Dynamic Rating will also be provided at: <http://www.pjm.com/markets-and-operations/etools/oasis/system-information/ratings-information.aspx> for the next 48 hours if available.

For more information on TERM application specific functionality please see training materials identified in Appendix B.

Appendix B: eDART Application Functionality Training (including Network Model and TERM Applications)

eDART is a suite of applications used for engineer and dispatch coordination between PJM members and PJM staff. Some applications are used for modeling purposes, including TERM and Network Model Applications. The eDART application is available on the web via <https://edart.pjm.com/mui/index.htm>. There is a training environment available: <https://edarttrain.pjm.com/mui/index.htm>.

In addition, eDART Training is online at: <https://pjm.com/markets-and-operations/etools/edart.aspx> (PJM.com > Markets & Operations > PJM Tools > eDART).

The site includes a User Guide with full detail on application functionality, and other application-related training, including Power Point presentations and interactive guides with voice instruction.

The Network Model Application allows users to:

- Create new EMS Model Change Projects
- Review and revise project submission information
- Create reports
- Communicate project information to others

Information for the model build is submitted into eDART Network Model. This application is available to Transmission eDART users only.

Appendix C: Bulk Electric System (BES) Definition Implementation at PJM

Bulk Electric System (BES) Implementation at PJM

PJM is committed to operating the bulk electric system reliably and efficiently at all times. To accomplish this, PJM employs many tools and processes to meet industry standards established to ensure reliability and serve the electric utility industry and its customers.

All transmission facilities operated by PJM fall within one of two NERC Regional Entities: ReliabilityFirst or SERC. In 2013, NERC approved a definition of the Bulk Electric System (BES) to be applied uniformly for all Regional Reliability Organizations. The definition focuses on equipment rated 100 kV or higher to establish key elements and equipment in the transmission (Bulk Electric) system. In this definition, radial components of the system are excluded, provided they meet the required criteria. The definition also accommodates the inclusion of equipment rated below 100 kV which may impact through transmission components of the electric system. Transmission Owners are responsible for defining BES elements for their systems, as well as, any exclusions or inclusions. To comply with NERC standards, these key elements must be identified and appropriately monitored. As such, each Transmission Owner should notify PJM if any existing elements have been excluded, or any new elements have been included, in its transmission area. In most, but not all, cases, PJM will model these elements explicitly to determine whether the equipment is in service (status) or that thermal loading or voltage levels deviate from recommended limits.

The following discussion, provided for your information, summarizes PJM's BES implementation approach.

Discussion

PJM has implemented BES as a part of established activities, processes, and functions. Facilities included in the BES augment practices originally established to monitor and assess elements of the transmission system associated with administration of the PJM Market and to support NERC Reliability Coordination (RC) functions.

Note:

Coordination for BES facilities is required by using NERC's BESnet tool and the PJM Compliance Bulletin 14. When entries are made in the NERC BESnet tool, PJM members are also required to send a notice of these change requests to the DMS_Officers@pjm.com e-mail, per PJM Compliance Bulletin 14. PJM employs a multi-tiered strategy to ensure system reliability. BES equipment is recognized in all appropriate planning and operations processes and functions. Since a wide array of offline and online transmission studies are performed, facilities included in the BES are under constant review.

Long-term and near-term offline studies review expected conditions based on load forecasts and include the effects of planned system modifications. Planned maintenance is reflected in the studies where known and applicable. Unplanned and unanticipated outages are simulated via contingency analysis. The offline studies employ load flow and dynamic stability tools to determine if the projected conditions represent a secure and viable operating condition. If problems are uncovered, solutions are formulated and plans are made to modify the system as required.

As the timeframe reduces from long-term to near-term and then to real-time, different analysis tools are employed. To study actual conditions, PJM employs state of the art tools such as SE, SA, etc., to assess the 'health of the system'. These evaluations run continuously, cycling through almost every minute of the day, 24 hours a day, 7 days a week. These analytical tools determine if unacceptable loading or voltage conditions exist or can be expected for thousands of potential outages. The online tools can also be used to help develop remedies to problems that are uncovered and evaluate the efficacy of various options proposed that ensure the system will continue operations in a secure state for the myriad of postulated contingency conditions.

The base conditions and outages/contingencies studied periodically in offline simulations represent hypothetical conditions consistent with NERC TPL and TOP standards. Events simulating Category A (System Normal), Category B (Loss of single BES element), Category C (Loss of two or more BES elements) and Category D (Extreme events) are simulated as required (defined in NERC TPL standards). These studies assess the system's ability to withstand these types of adverse events. If problems are identified in the analysis, a variety of system adjustments are then employed to counteract adverse events, well in advance of the actual occurrence of the problem identified.

For online studies, equipment maintenance is often represented as part of the base conditions. Events simulating NERC Category A and Category B contingencies are studied continuously by the SE and SA tools employed in the PJM EMS. Depending upon the type of problem identified, PJM operators are trained to take action to ensure that the system remains reliable. Category C and Category D outages are also simulated online as required.

To assess both study and near real-time conditions, facility loading is evaluated as a function of equipment capability. Voltages are also concurrently assessed as a function of acceptable high and low limits. Voltage changes which occur in response to the simulated contingencies are also compared to specified limits. Thousands of hypothetical contingencies (outages) are investigated to determine if any BES elements will be adversely impacted.

Although not comprehensive, the following list cites several types of key studies that are routinely performed:

- Offline, long-term, Regional Transmission Expansion Planning studies
- Generation Deliverability planning studies
- Seasonal Operations Analysis studies
- Short-term (daily to 6 months) Outage Coordination studies
- Very near-term studies during peak load conditions
- Periodic State Estimation and Security Analysis by both PJM and TOs

Note that PJM will also work with the staff of member companies to investigate circumstances and conditions which warrant special attention.

Electrical Models

PJM uses well established models of lines, series devices, shunts, transformers, phase shifters, and generators in the various off-line and real-time studies. Due to the nature of the calculations used to evaluate electric system models, it is not always feasible to directly monitor some

components of the BES. For instance, in the real-time models, the current status of switches and breakers is automatically used by the software to develop ‘bus’ models of the system at a given point in time based on telemetered status information. This renders an accurate ‘bus’ representation of current system conditions reflecting current maintenance activities as well as prevailing load and generation patterns. Status information is also used to simulate or monitor the effects of switched BES shunt devices such as capacitors and reactors in PJM operation’s models. For off-line studies, it is generally presumed that switches and/or breakers are in their normal open or close position and ‘bus’ models are derived by the user. If maintenance or other ‘abnormal’ system conditions are modeled, the user must adapt the model accordingly.

PJM’s focus is on the wide-area network, concentrating on the loading of major equipment, such as lines, transformers, series devices, phase shifters, generators, etc. There are several reasons for carefully selecting components to model (or not model). PJM’s online SE/SA tools employ lumped parameter models. Hence these tools do not directly calculate flows through switches and breakers, etc., as they are near zero-impedance devices. There are other, very low impedance connections such as drops, loops, taps, and bus sections that also do not lend themselves to explicit real-time models with the available tools. It can be demonstrated that representing very low impedance elements can cause numerical instability. The addition of numerous very low impedance connections would also tend to reduce throughput by increasing SE and Contingency Analysis computing time. For these reasons, PJM does not generally represent very low impedance connections and devices in real-time analysis. Given current tools, it is recommended that very low impedance devices be reviewed in off-line studies to assess all possible substation configurations as part of the Transmission Owner’s planning process. If loading problems of specific, very low impedance devices are uncovered in the TO’s analysis, the TOs should make appropriate system modifications to alleviate the problem. If insufficient lead time exists to mitigate the problem, PJM will work with the TO to develop appropriate tools, alarms and procedures to reliably monitor specific equipment as an interim measure. TOs will be responsible for providing data and/or information to support monitoring the facilities in question should the need arise (as described in M-01, Control Center Requirements).

There may also be special modeling considerations which limit the need to directly model select equipment in the EMS model. These special considerations may include:

- Individual turbines in a ‘wind farm’
- Phase Shifters
- DC lines
- Other non-synchronized facilities (e.g., 25 cycle railroad equipment)

This equipment may be represented as either a load (sink) or generator (source) for online security purposes and may not be explicitly modeled as part of the BES. Maximum loading conditions are predetermined through off-line study. Flows are restricted in the model to the prescribed load and generation levels. For online models, wind farm generation is modeled by simulating ‘aggregate’ generators at points connected to the Bulk Electric System via step-up transformers.

Ratings for the modeled equipment are derived and provided by the TO. These are applied to the ‘major equipment’ noted above. Typically, limits applied to the modeled lines and

transformers are modified to account for ‘line or transformer drops’, ‘bus-bars’, etc., since these are essentially zero impedance devices and are not readily modeled. Auxiliary equipment components are not explicitly modeled by PJM (e.g., CTs, PTs, wave traps, and relays). The impact of these devices is reflected in the limits applied to modeled equipment and to establish the contingencies to be evaluated. Since PJM requires metering for real-time models, power outputs from the plant are accurate and consistent with the aggregate plant output at all times.

Since equipment can be monitored for a number of different reasons, it is necessary to categorize components of the overall electric system monitoring effort. The various types of monitored equipment are categorized as shown in Exhibit 15 as follows:

Priority	Name	Description
0	Not monitored, No status	Also referred to as Unmonitored, applies to facilities which may, or may not, be modeled in the PJM EMS. No significant impact on system loading is expected to result from outages on these facilities. PJM's EMS does not maintain ratings/limits for these facilities.
1	Reliability & Markets	Applies to internal PJM facilities under Congestion Management. TOs are required to report all outages under this classification. If actual or post-contingency exceedances occur on these facilities, operators follow appropriate procedures, including market re-dispatch, to remediate problems. PJM's EMS maintains ratings/limits for the facilities.
2	Reliability BES	Applies to facilities defined as part of the Bulk Electric System (BES) or facilities PJM is responsible for as NERC Security/Reliability Coordinator. These facilities are not included in Reliability & Markets. May also apply to internal PJM facilities impacted by switching/ phase shifter operations on parallel PJM facilities which are under Congestion Management. TOs are required to report all outages under this classification. If actual or calculated overloads occur, operators follow appropriate procedures to remediate the problem. Facility owners are responsible for any off-cost operation incurred. PJM's EMS maintains ratings/limits for these facilities.
3	Status Only	TOs are required to report outages on facilities that are not in Congestion Management but may impact the reliability and/or economics of the system. TOs are required to follow applicable outage reporting procedures for facilities classified as Reportable <u>Yes</u> and Reportable <u>Low</u> in the Reportable Transmission Facility column of the PJM Monitored Facilities list. The primary difference in these classifications is that for Reportable <u>Yes</u> facilities, TOs are required to call before and after taking outages, whereas TOs are not required to call PJM before taking an outage on Reportable <u>Low</u> facilities. TOs are not required to report outages on facilities classified as Reportable <u>No</u> to PJM. PJM can require that any, or all, OATT facilities be Outage Reportable. PJM's EMS does not maintain ratings/limits for these facilities.

Priority	Name	Description
4	External Reliability	Similar to priority 2 but non-PJM facilities. These external facilities could impact the PJM system as part of Market-to-Market Congestion Management flow-gate coordination between adjacent RTOs. PJM's EMS maintains ratings/limits for these facilities.
5	External Status Only	Similar to priority 3 but applies to external, non-PJM facilities. PJM's EMS does not maintain ratings/limits for these facilities.
6	Reliability Non-BES	Similar to priority 2 but applies to facilities that may be monitored for loading by PJM but are not included as Markets & Reliability or BES facilities. Facilities are generally included in this category at the request of the transmission owner. TOs are required to follow applicable outage reporting procedures for facilities classified as Reportable Yes and Reportable Low in the Reportable Transmission Facility column of the PJM Monitored Facilities list. If actual or calculated overloads occur, operators develop remedial strategies in cooperation with the facility owner. Corrective strategies are implemented as approved by the owner. Owners assume responsibility for off-cost operation. PJM's EMS maintains ratings/limits for these facilities.
7	Generation Equipment	Similar to priority 2, but applies to generation equipment. Facility owners are responsible for costs incurred to remediate problems. TOs are required to follow applicable outage reporting procedures for facilities classified as Reportable Yes and Reportable Low in the Reportable Transmission Facility column of the PJM Monitored Facilities list. PJM's EMS maintains ratings/limits for these facilities.
8	Pending	Applies to facilities that are candidates for, but not yet approved, inclusion in Reliability & Markets or facilities that are modeled but not yet in-service.
	General Notes: Doc #331840	For Security Analysis, PJM the EMS is typically set to monitor all facilities with priority 1 through 5. As required, these settings are changed to include the remaining facility categories. These facility classifications are utilized in PJM planning and operations.

Exhibit 14: List of Monitored Priorities

Note:

The specific requirements associated to Reportable Yes, Low, and No are detailed in Manual 03 Transmission Operations, Section 1.5.4 'Reportable Transmission Facility'.

Any BES facility limitations which cannot be modeled or approximated readily by PJM can typically be monitored by adjusting major equipment limits. When this is not feasible, PJM works with TOs to develop appropriate mechanisms to avoid potential problems.

PJM's analysis of the electric system is not limited to equipment identified as part of the BES. In addition to fully integrating, qualifying BES electric system components into all analyses, PJM

also models and monitors additional system components. These components may be required for operation of the PJM Reliability & Market or for security analysis of non-BES and/or non-PJM Market facilities. That is, BES elements are a subset of all the components that are modeled and monitored as members of the PJM Monitored Facilities list.

Components of the PJM Monitored Facilities list, including modeled BES facilities, are published on the PJM website at: <http://www.pjm.com/markets-and-operations/ops-analysis/transmission-facilities.aspx>

For clarity, it is important to note that to ensure high fidelity models and accurate simulations of the actual electric system; some equipment that is not included in PJM Monitored Facilities is also modeled. This equipment can represent either internal or external (non-PJM) facilities. These facilities are generally not listed on the website.

BES Protective Equipment

PJM routinely completes off-line planning studies to investigate normal conditions, single contingencies as well as the impact of the simultaneous loss of multiple BES elements and delayed clearing and/or failures of interrupting devices. Appropriate measures are taken to upgrade or mitigate the circumstances when problems are identified. PJM also studies breaker duties and assesses Dynamic Stability via off-line studies.

The impact of the action of protective equipment, including the protection associated with or impacting BES facilities is incorporated into near-term and real-time studies by constructing contingencies to simulate expected operations to isolate problems from the system. In addition to studying Normal or Steady-State operating conditions to ensure a secure operating state, PJM constructs and studies outages for periodic evaluation (about two (2) minutes). These outages simulate the operation of primary protection schemes employed by the TOs (consistent with NERC Category B). This is substation specific and presumes that protective relays will operate as designed to open the nearest fault clearing devices. Since the PJM EMS uses real-time status to determine connectivity, the impacts of abnormal opened and closed switches and breakers is automatically reflected in the security analysis models. TOs are responsible for alerting PJM if primary relay schemes are disarmed and/or alternate protection schemes are in place. Using this information, PJM will adjust the periodically monitored contingencies to reflect these conditions.

Bus faults and failures of protective devices (Category C and Category D) can also be modeled and reviewed on an ad hoc basis via the real-time analysis tools.

Appendix D: Deleted

Appendix E: Checklist For New Equipment Energization Process

The following checklist has been created for use by Transmission Owners and Designated Entities as a guideline for what is required by PJM throughout the baseline/supplemental transmission upgrade process from inception to energization.

For more detailed information please refer to the training series: Transmission Planning, Modeling, and Energization which can be accessed from any of the following pages on Pjm.com:

<http://www.pjm.com/planning/rtep-development.aspx>; <http://www.pjm.com/planning/rtep-development/powerflow-cases.aspx>

<http://www.pjm.com/planning/design-engineering.aspx>; <http://www.pjm.com/markets-and-operations/ops-analysis.aspx>

Project Phase ¹	Task	Delivery	Timeframe	PJM Manual Reference	PJM Contact Department	Comments
P	Submit minimum required rating (lines and xfmrs)	Email to contact	Before Project Approval	M-14B	Transmission Planning	
P	Submit planning model parameters	IDEV/ Project File	Before Project Approval	M-14B	Transmission Planning	
P	Submit planning contingency changes	CON File	Before Project Approval	M-14B	Transmission Planning	
P	Submit breaker diagrams	Email to contact	Before Project Approval	M-14B	Transmission Planning	
P	Project Description/Cost/ Time Estimate	Email to contact	Before Project Approval	M-14B	Transmission Planning	
EP	Construction Schedule/Project Sequence	Email to contact	6-8 months prior to UC phase	M-14C	Infrastructure Coordination	
EP	Submit projected outage timeframes	Email to contact	6-8 months prior to UC phase	M-14C	Infrastructure Coordination	

Project Phase ¹	Task	Delivery	Timeframe	PJM Manual Reference	PJM Contact Department	Comments
UC	Quarterly updates	Email to contact	Throughout UC phase	M-14C	Infrastructure Coordination	
EP/UC	Submit as built impedance and all other applicable equipment parameters (i.e. Tap Settings, Capacitor Size etc.)	eDART – Network Model Ticket	6-12 months prior to IS	M-03A; 3.2	Power Systems Modeling	
EP/UC	Submit final In-Service Date	eDART – Network Model Ticket	6-12 months prior to IS	M-03A; 3.2	Power Systems Modeling	
EP/UC	Submit target build date	eDART – Network Model Ticket	6-12 months prior to IS	M-03A; 3.2	Power Systems Modeling	
EP/UC	Submit equipment names	eDART – Network Model Ticket	6-12 months prior to IS	M-03A; 3.2	Power Systems Modeling	
EP/UC	Submit final one-line diagrams	eDART – Network Model Ticket	6-12 months prior to IS	M-03A; 3.2	Power Systems Modeling	
EP/UC	Submit Transmission Outage Tickets	eDART	2-12 months prior to IS	M-03; 4.2	Transmission Operations	
EP/UC	Submit Ratings (Lines and Transformers)	eDART – TERM	No later than 2 weeks prior to IS	M-03A; 3.2	EMS Support TERMTickets@pjm.com	
EP/UC	Submit Telemetry	Email	No later than 2	M-03A; 3.2	EMS Support	

Project Phase ¹	Task	Delivery	Timeframe	PJM Manual Reference	PJM Contact Department	Comments
			weeks prior to IS		PJMTelemetrySupport@pjm.com	
EP/UC	Submit As built date	Project File	IS Date	M14B	Transmission Planning	
UC/IS	Notification of In-Service status	Email	Once facility is energized	M-14C	Infrastructure Coordination	

Exhibit 15: Checklist for New Equipment Energization Process

¹Key: **P** = Pending (or before Pending), **EP** = Engineering and Procurement, **UC** = Under Construction, **IS** = In-Service

Note:

For maximum exposure to various members, identical copies of this table can be found in PJM Manuals 03A, 14B and 14C.

Appendix F: Acronyms & Descriptions

The following table outlines Acronyms and Descriptions referenced throughout M-03A:

Acronym	Description
AGC	Automatic Generation Control
ATC	Available Transfer Capability
BA	Balancing Authority
BES	Bulk Electric System
BtMG	Behind the Meter Generator
CA	Contingency Analysis Program
DER	Distributed Energy Resources
DFAX	Distribution Factors
DMS	Data Management Subcommittee
eDART	Electronic Dispatcher Applications and Reporting Tool
EHV	Extra High Voltage
EMS	Energy Management System
FTR	Financial Transmission Right
GIS	Geographic Information System
GPS	Global Positioning Satellites
ICCP	Inter-Control Center Communication Protocol
IROL	Interconnection Reliability Operating Limit
ISO	Independent System Operator
JOA	Joint Operating Agreement
LCC	Local Control Center
LMP	Locational Marginal Price
LTC or TCUL	Transformer Load Tap Changer
MMWG	Multi-Area Modeling Working Group
NDA	Non-Disclosure Agreement
NERC	North American Electric Reliability Council

Acronym	Description
OASIS	Open Access Same-Time Information System
OATT	Open Access Transmission Tariff
ORNS	Operating Representatives of Northeast Systems
PAT	Phase Angle Regulator
PMU	Phasor Measurement Unit
PSS/E	Power System Simulator Equation
RE	PJM Reliability Engineer
RTEP	Regional Transmission Expansion Plan
RTLMP	Real Time Location Marginal Price
RTO	Regional Transmission Organization
SA	Security Analysis
SCADA	A system of remote control and telemetry used to monitor and control the electric system.
SCED	Security Constrained Economic Dispatch
SE	State Estimator
SERC	South Eastern Electric Reliability Council
SOL	System Operating Limit
SOS	System Operations Subcommittee
SOS-T	System Operations Subcommittee-Transmission
SVC	Static VAR Compensator
TERM	Thermal Equipment Ratings Monitor
TNA	Transmission Network Application
TO	Transmission Owner
TOA	Transmission Owner's Agreement
TOP	Transmission Operator
TPL	Transmission Planner
TSA	Transient Stability Analysis

Acronym	Description
WAV	Wide Area View

Appendix G: Examples of EMS Sub-transmission Modeling

Example 1: 69KV Network in an Area Surrounded by BES Source Stations:

In some locations there are multiple BES sources supplying a 69 kV network which ties the BES system together. This can impact a fairly large geographical area. Typically, the sub-transmission facilities can provide support to the BES under a wide array of situations. Simply using a telemetered load at BES source locations, without recognizing the effects of the sub-transmission network, can prevent PJM dispatchers from observing the same system issues as their member company counterparts (situational awareness). Since PJM practice dictates that the 'most conservative' approach be followed, the system may subsequently operate at sub-optimal levels - unless a decision is made to use the TO's more detailed model. Based on operational experience, PJM and the TO may opt to include models of the sub-transmission facilities in the area to have a consistent situational awareness in the PJM and TO control rooms. Similarly, in locations where planned outages will force additional flows on the sub-transmission network diverting flows to other BES facilities, modeling might be required before an outage request is granted.

Example 2: 69KV Network as Backbone Modeling Considerations:

For some TO systems, a substantial percentage of the system backbone is 69 KV network, requiring an extensive 69 KV model to support an accurate SE solution and calculation of actual flows on BES facilities. PJM can model this sub-transmission in detail with limit checks in place with Monitored Priority 6, Reliability non-BES. Limit checks on these facilities are then customarily performed only as appropriate, or by exception, during outage analysis. These models are important so that PJM and the corresponding TO observe similar results when simulating various outages. The added detail improves correlation between the TO and PJM models, mitigating the need to defer to more conservative result. Without this additional detail, the PJM dispatchers and REs would not have consistent situational awareness as there would be too many missing elements in the PJM system model.

Example 3: Sub-transmission Modeling Complexities – External Company Considerations:

In some cases, under 100 kV facilities constitute a large portion of the company's backbone system with multiple low voltage connections to neighbors. In these cases, sub-transmission elements of neighboring systems will likely impact SE solution accuracy. If the neighbor is not a PJM member, tie-line accounting will also be impacted and employing a detailed sub-transmission model will improve SE and SA numerical stability and EMS performance. Some PJM member stations and their loads can also be interspersed among another neighboring company's stations. Modeling of the sub-transmission can be used to address this type of issue.

Revision History

Revision 22 (10/25/2022)

- Periodic Review
 - Flow Device Language Clarification
 - Tie-Line Link Update (error)
 - Monitoring Priorities Clarifications/Default New Equipment
 - Model Management Department to Power Systems Modeling

Revision 21 (05/25/2022):

- Appendix A: Added information about Dynamic Ratings processing.

Revision 20 (08/25/2021):

- Periodic Review
 - Periodic review is up to date with no changes.
- Compliance Reliance ACA Update
 - Updated Section 2.2 to clarify instructions for a Transmission Owner to add, remove, and/or convert a flow device and submit the associated ratings.

Administrative Change (03/29/2021):

- Updated manual ownership from Ryan Nice to Jeff Schmitt

Revision 19 (11/19/2020):

- Periodic Review:
 - Grammatical change throughout to remove 'Electrical Management System' where EMS acronym appears.
 - Section 1.2.1: Behind The Meter Generation (BTMG) updated to remove text outlining processes and procedures; reference added to refer to Manual 14D, Appendix A as primary source for all BTMG processes and responsibilities.
 - Section 3.4: Updated to reflect eDART Base Data Application as correct location for viewing impedance information (no longer TERM).
 - Section 4.2: Revised to remove out-of-date information.
 - Section 5.3: Text previously removed in error during Rev. 18 added back to section; reference to M03, Section 1.3 removed.
 - Attachment A: TERM Equipment Ratings Update Process revised to reflect current procedures; text streamlined to remove duplication.
 - Attachment D: BTMG Modeling Information Form removed from M03A per revisions made at Section 1.2.1.

- o Exhibits 15, 16, 17 supporting BTMG subject matter removed.

Administrative Change (05/05/2020):

- Updated hyperlinks, in Appendix B eDART Application Functionality Training including Network Model and TERM Applications, to correct path & added language and hyperlink to available training environment:
 - o "The eDART application is available on the web via <https://edart.pjm.com/mui/index.htm>. There is a training environment available: <https://edarttrain.pjm.com/mui/index.htm>.
 - o In addition, eDART Training is online at: <https://pjm.com/markets-and-operations/etools/edart.aspx> (PJM.com # Markets & Operations # PJM Tools # eDART)"
- Deleted "a Quick Reference Guide, which is a shortened version of the User Guide," in Appendix B, from site user guide paragraph.

Administrative Change (01/15/2020):

- Updated manual ownership from Ron DeLoach to Ryan Nice

Revision 18 (12/05/2019):

Periodic Review:

- Overall: Corrected all references to Pseudo-Ties to align with Tariff reference.
- Section 1.2: Formatting changes; generator data descriptions removed; outdated procedure removed.
- Section 1.5: Overall description of PJM's use of 'three concentric model' revised and updated.
- Exhibit 1: Replaced with updated version; layers renamed for clarity.
- Section 1.6: Formatting changes; updates made to text to reflect current procedures. New note added to specify PJM timelines for TOs to provide telemetry and, for members with ICCP connection, a full SCADA file (text moved from 3.5).
- Section 1.7: The words 'Real-Time' removed from title (now reads: PJM's Operations Transient Stability Model); section updated to reflect current procedures.
- Section 2: Opening paragraph revised to reflect updated content. Entire section redesigned to reflect PJM's overall modeling philosophy. New sections added:
 - o 2.2.1 Internal World Modeling Philosophy (BES Facility Modeling, Sub-transmission Modeling)
 - o 2.2.2 Sub-transmission Modeling Criterion and Responsibilities
 - o 2.2.3 PJM External World Modeling (External World Modeling, Model Exchange and Extraction, Pseudo Tie Modeling, Pseudo Tie Eligibility, Pseudo Tie EMS Modeling)
 - o 2.2.4 Naming and Modeling Standards
 - o 2.2.5 Unique Device Consideration in the PJM Model.

- Section 2.2.3.1: Removed criteria to the extent of external BES equipment to be considered for modeling.
- Section 3.2: The following content is moved from Section 4.9 to Section 3.2:
 - o Prepare Initial BES Data to Denote BES Elements of the System
 - o TO and PJM Staff Responsibilities:
 - TO Staff Responsibilities – To Address BES Definitions
 - PJM Staff Responsibilities – To Address Revised BES Definitions
 - PJM Staff Responsibilities – Ongoing Sub-transmission Modeling Considerations
 - o Exhibit 10: Updated screen shot added for Sample TO Facilities List
- Section 3.4: Text revised to reflect updated procedures when changing transformers and shunts.
- Section 3.5: Section removed; content moved to new Section 2.2.4 Naming and Modeling Standards
- Section 4.3: Exhibit 6: One-line Diagram Symbols updated with clearer version (no change to content)
- Section 4.8: DMS section updated to remove stipulation of SOS appointment of DMS members (per revised DMS Charter); requirements for access to DMS SharePoint added (active, signed NDA on file in eDART); content streamlined.
- Section 4.9: Section removed; topics relocated to Sections 2.2, Section 3.2, and (new) Appendix G (Examples of EMS Sub-transmission Modeling).
- Section 5: Section updated, reorganized, and consolidated to reflect updated processes and procedures
- Section 5.1: Formatting and updates made to content
- Section 5.2: Text moved, updated, or deleted to reflect current procedures
- Section 5.3:
 - o Heading changed from ‘New EMS Models Validation and Benchmarking’ to ‘Real-time Contingency Analysis (RTCA) and Solution Quality’
 - o Text addressing PJM’s Security Analysis (SA) Program and RTCA Data Quality moved from Section 5.5
- Section 5.4:
 - o Title changed from ‘Real-time Contingency Analysis (RTCA)’ to ‘New EMS Models Validation and Benchmarking’
 - o Added text addressing changes to PJM EMS and ‘soak test’ prior to moving changes to production (moved from Section 5.3)
 - o Added bullet list of criteria and note addressing readiness for installing new model added (moved from Section 5.3)

- Section 5.5:
 - o Text realigned to Section 5.3 (at section addressing PJM's Security Analysis (SA) Program and RTCA Data Quality)
 - o Section removed
- Appendix F: New entry added for DER: Distributed Energy Resources
- Appendix G: New appendix added for Examples of EMS Sub-transmission Modeling

Revision 17 (10/31/2018):

- Section 3.2.1: Clarity added concerning extent of external BES facilities considered for modeling.
- Section 3.2.1.1: Removed non-official standard

Revision 16 (09/27/2018):

- Section 1.2.1: Reference to Manual 14D added for BtMG reporting and communication

Revision 15 (08/01/2018):

- Cover-to-Cover Periodic Review
- References to Exhibit numbers updated throughout document.
- Section 1.6: Sentence added to note applicability of technical requirements to PJM TOP facilities and facilities outside the PJM TOP area.
- Section 1.6: Reference to Manual 1, Section 3.8.1 added for specifics on coordination efforts and allowable timeframes for ICCP planned outages.
- Section 2.2: New section added for Flow Circuit Breakers outlining description and change instructions.
- Section 2.2: Note modified to reference Manual 1, Control Center and Data Exchange Requirements.
- Section 2.4: Updated steps added to access Transmission Facilities page on pjm.com.
- Section 2.4, Exhibit 2: Updated screenshot from new location of Transmission Facilities pages on pjm.com.
- Section 2.4.3: Section updated to reflect current process steps.
- Section 3.2: New section for Phased Projects added, with accompanying Note providing an example.
- Section 5: Reference to Contingency Analysis (CA) changed to Real-Time Contingency Analysis (RTCA) to identify function by NERC naming convention and Security Analysis (SA) to represent PJM tool used to run contingency analysis.
- Appendix C: Outlined outage reporting requirements on a per priority basis and referenced Manual 03 for latest details.

Revision 14 (04/01/2018):

- New Section 5.6: Quality of Analysis Used in Real-time Assessments

Revision 13 (09/29/2017):

- Cover to Cover Periodic Review
- Non-substantive changes to format and references
- References: eDART Training Presentations link updated
- Section 1.3: Link added for online training presentations on model update related processes & procedures
- Section 2.2: Note added to address process to change to Flow CB
- Section 3.2:
 - Content reordering and reformatting for improved readability and flow
 - o Reference note added to Appendix E: Checklist for New Equipment Energization Process
 - o Referenced Manual 14B and online training for Supplemental Upgrades submission to PJM Planning
 - o Updated list of required items needed for Network Model update submissions
 - o Note added for Exhibit C1 outlining which facilities require ratings
 - o Details added about process to link Network Model Requests to associated Cut-in Transmission Outage Tickets
 - o Details outlined for areas needing TO review in line with the model update process
 - o Removed EHV Modeling as separate section (formerly 3.2.1) and made as Note in Section 3.2
 - Exhibit 5 moved from Section 3.2.1 to Section 3.2
- New Section 3.2.1 - External Modeling
 - o Moved external modeling specific verbiage from Section 3.2 to new Section 3.2.1
 - o New Section 3.2.1.1 – Pseudo-Tie Modeling used to identify PJM model update need for approved Pseudo-Ties
 - Points to Manual 12 for Pseudo-Tie consideration requirements
- Section 3.3: Updated to reflect capability to enter ratings for flow breakers.
- Section 3.5: Clarification added to generator unit naming requirements
- Section 4.4:
 - o Elaboration added on Tie Line process; reference added to M01, Attachment D: Tie Line Meter Placement and Telemetry
 - o New Exhibit 8: Tie Line Update Timeline added
 - Exhibit numbers updated per insertion of new Exhibit 8

- Section 4.8: Updated DMS parent committee & meeting occurrences
- Appendix A: Title changed to 'TERM Equipment Ratings Update Process'
- Appendix C: Reference to NERC BES process and PJM white paper changed to a Note
- Appendix E: Note added with references to Manual 14B and Manual 14C
- Appendix F: Acronyms & Descriptions updated

Administrative Change (09/30/2016):

- Appendix E:
 - Added hyperlinks for Training Series: Transition Planning, Modeling and Energization
 - Removed column entitled "Online Training Links"

Revision 12 (09/30/2016):

- References: Link to PJM Transmission Services added to online reference table.
- Section 2.2: Reference added for new Appendix E: Checklist For New Equipment Energization Process.
- Section 4.4: Reference added to Manual 01 for tie line reference and requirements; text updated for accuracy.
- Appendix E: New appendix added for Checklist For New Equipment Energization Process.
- New Exhibit E1: Checklist For New Equipment Energization Process
- Appendix F: Previously Appendix E, Acronyms & Descriptions, now Appendix F.

Revision 11 (08/25/2016):

- Cover to Cover Periodic Review
- Updated URL for Tariff Facilities List throughout document
- Miscellaneous administrative and formatting updates
- Section 1.2: Submission timelines and detail added for modeling updates specific to Generators.
- Section 1.2.1: New section outlining Electrical Model Responsibilities for Behind the Meter Generation (BtMG).
- Section 2.4: Text and Exhibit 12 moved from Section 4.9.3 to Section 2.4 (new Exhibit number is 2); link added to Transmission Services Tariff Facilities list.
- Section 3.1: The word 'document' replaced with 'section'; grammar clarified.
- Section 3.2: Submit-on-time functionality and process outlined; (old) Exhibit 3 deleted (redundant/confusing); (new) Exhibit 3 (General Schedule for Submitting Modeling Data) enhanced distinguish between Required and Preferred In Service Date for Project; Exhibit 4 (Network Model Data Submission and Model Validation Timeline) enhanced

to display corrected timelines, and new timelines added for 'Preferred In Model Build' and 'PJM Tests New Model'.

- Section 3.2.1: New section added for EHV Modeling.
- Section 3.3: Grammar clarified.
- Section 3.4: Paragraph added to outline non-automated process for submitting fixed tap changes to PJM.
- Section 4.1: Paragraph 5 updated to reflect current practices and reference to DMS SharePoint postings added.
- Section 4.8.1: Sharing of data and one-lines across DMS members outlined.
- Section 4.9: Reference added for PJM Sub-Transmission Modeling White Paper.
- Section 4.9.3: Instructions added for BES notification of BES exceptions; Exhibit 12 and preceding paragraph moved to Section 2.4 (now Exhibit 2).
- Appendix C: New paragraph added to outline BESNet process with supporting web links.
- Appendix D: New Appendix added for new Behind the Meter Generation (BtMG) Submission Form and outlining procedure for form submission.
- New Exhibit D1: Blank PJM Behind the Meter Generation Submission Form
- New Exhibit D2: Sample PJM Behind the Meter Generation Submission Form for Distribution, with supporting one-line diagram
- New Exhibit D3: Sample PJM Behind the Meter Generation Submission Form for Transmission, with supporting one-line diagram
- Appendix E: Acronyms & Descriptions moved from Appendix D to Appendix E to accommodate new Appendix D for BtMG

Revision 10 (06/25/2015):

- Section 1.4: Updated to point to Manuals 3 and 37 as source for operating guidelines and system limitation processes and procedures.
- Section 1.6: Real-Time Telemetry Data Requirements for System Reliability – change 34kV references to 69kV. Under Status Data requirement, third bulleted item deleted (incorrect).
- Section 3.2: Identified energization date as basis for submission dates for phased project updates. Also cleaned up and simplified language around model types.
- Section 3.5: Naming Conventions: added SC: Synchronous Condenser to list of units.
- Section 4.2: Administrative change required to update link to FTR Model page and add new link to CEII Access Request form Section 4.3: Updated Exhibit 7
- Section 4.9: New Sub-Transmission Modeling section added
- Section 4.9.3: New Exhibits 11 and 12 and Examples section added to support Sub-Transmission Modeling.

- Section 5.2: Combined sub-sections 5.2.1 and 5.2.2; renamed section 5.2
- Section 6: No member-related business processes tied to this section.
- Appendix A: TERM section revised/updated.
- Appendix A: New Exhibit A1 added (TERM Ticket Submission Process)
- Appendix A: New Exhibit A2 added (Examples of TERM ticket submissions (Permanent and Temporary) and resulting status changes)
- Appendix A: New Exhibit A3 added (Sample TERM Bulk Upload file)
- Appendix C: Exhibit C1 table updated with clearer version of the same table of types of monitored equipment
- Appendix D: Two acronyms added to table (IROL, SOL)

Revision 09 (01/22/2015):

- Formatting changes made throughout entire document
- References Section: New table added for 'Important Links'
- Section 1.5: Keeping the Steady-state Model Current section enhanced
- Section 2.2:
 - o Reference information added to Network Model Submissions section
 - o Specific SVC Modeling Requirements added
- Section 2.4.2: Responsibilities of DMS Officers and format revisions made to Congestion Management Change Process
- Section 3.2:
 - o Exhibits 2, 3, & 5 updated
 - o New Exhibit 4 added
 - o GIS Data Submission detail added
 - o Additional mention of SVC Modeling Requirements
- Section 4.1: Text updated, Exhibit 6 updated
- Section 4.3: Exhibit 7 deleted (replaced with new Exhibit 4 in Sec. 3.2)
- Section 4.5: Cut-in
 - o Tracking/Review/Notification clarified
 - o Exhibits 9, 10, & 11 updated
- Section 4.8:
 - o DMS section re-written/updated
 - o New section 4.8.1 added re: new DMS SharePoint site
- Section 5: Section headings edited/streamlined

- Section 7: Removed (redundant information)
- Appendix C: Exhibit C1 added
- New Appendix D added: Acronyms & Descriptions
- Appendix A: Administrative revision to correct TERM access steps

Revision 08 (01/02/2014):

- Model Management Manager & Manual Owner changed to Ron DeLoach
- Updated Exhibit 4 to include EKPC in detailed, SE model
- Revised sections 4.1 to note that a PJM will make a detailed, preliminary model difference report available to TOs with admonition to use with caution
- Revised section 5.1.2 to include model validation and benchmark tests incorporated in response to FERC Audit Recommendation 13
- Added another sub-section to Appendix A: Processing Ratings in Short Notice, Emergency Situations
- Modified Appendix C: Bulk Electric System (BES) Definition Implementation at PJM to accommodate new NERC definition

Revision 07 (07/10/2013):

- Engineering Support to Model Management, John Baranowski, mgr
- Responsibility for ratings to RealTime Data Management, Chris Smart, mgr
- References from DMWG to DMS0020
- Numerous edits throughout the entire document for clarity
- Section 1.2, specifies auxiliary loads, generator step-ups & telemetry model requirements to support BES
- Inserted new section 1.7 discussing TSA and data requirements
- Section 2.2 & 3.1 added references to transient stability data requirements including contingency definitions and clearing times in sections involving data requirements
- Section 3.3 defines emergency ratings as capability up to 4 hours and emergency ratings as capability up to 15 minutes
- Section 3.3 eliminated statement that 3% separation is required between emergency & load dump
- Added new Exhibit 5 illustrating the level of model detail in the overall PJM EMS model
- Added Solar Park to generator naming conventions in Section 3.5
- Provided reference locations for LMP and FTR load flow data in section 4.2 Bus Connectivity and Engineering Data
- Inserted new section 4.4 explaining Tie-line cut-in process requirements
- Section 4.5 (was 4.4) revised to describe Cut-in flags & reports

- Section 5.1 removed references to theory and reality
- Section 5.1.2 clarified to state that PJM's SE solution & dumps are provided to TOs upon request
- In Appendix A, TERM Processing Data Ratings Check List removed references to forced differentials between Normal, Emergency, and Load Dump ratings (see Section 3.3 changes)

Revision 06 (01/24/2011):

- Section 2.2 was expanded to include the physical location of substation equipment, including state and GPS coordinates.
- The Electrical Models section of Appendix C 'Bulk Electric System (BES) Implementation at PJM' was modified to discuss modeling and monitoring very low impedance equipment.
- Appendix A, TERM processing ratings data information concerning processing of temporary ratings changes was expanded.

Revision 05 (05/03/2010):

- Appendix A 'TERM Processing' was re-written and re-named 'Processing Ratings in TERM'. An explanation of new TERM Bulk Upload capability scheduled for implementation 2Q10 was also included.
- Appendix C 'Bulk Electric System (BES) Implementation' revised as follows:
- Removed indents from section headers to improve readability
- Added special modeling discussion to the Electrical Models section
- Inserted 'an' before ad hoc in last sentence

Revision 04 (05/05/2009):

- Denoted David Schweizer as manager of Power System Coordination Department, formerly Ken Seiler
- Added Appendix C Bulk Electric System (BES) Definition Implementation at PJM. A reference to the appendix was placed in Section 2 under the heading PJM Bulk Electric Transmission Facilities.
- In Section 3, PJM Ratings Data (Thermal Equipment Ratings Monitor – TERM), a paragraph was added to reference the ratings update procedures found in M3, Transmission Operating Guidelines.
- In Appendix A, TERM Processing Ratings data check list revised the monitored facility flag descriptions to be consistent with PJM's BES Implementation. Also noted that PJM's implementation of the Bulk Electric System definition requirement is outlined in M03 Appendices.

Revision 03 (09/25/2008):

- Section 2 Model Information and Transmission Facility Requirements was revised to remove duplication between M3, Section 1 and M3A, Section 2.
- Also clarified that the terms Congestion Management and Reliability & Markets are interchangeable.
- Added Background and Highlights of what TERM is and How It is Used at PJM to Appendix 1
- Updated references to other manuals.

Revision 02 (08/14/2008):

- BES Implementation
- The References section was updated to clarify that this manual references M-14D, Generator Operational Requirements.
- Terminology and references throughout the document were modified to ensure compliance with recently developed ReliabilityFirst & SERC definitions of the Bulk Electric System (BES). Note that the system facilities modeled, managed and monitored by PJM include, but are not limited to, those defined by the ReliabilityFirst & SERC definition.
- References to PJM model responsibilities throughout the document were modified to reflect current organizational structures/names.
- Section 1 was updated to clarify telemetry requirements for load-tap-changing (known as LTC or TCUL).
- Section 4 was updated to clarify that the transmission owner is responsible for verifying modifications to their models are accurate using feedback provided by PJM.

Revision 01 (05/15/2007):

- Changed the name of author from Mike Bryson to Ken Seiler.

Revision 00 (03/01/07):

This revision is the preliminary draft of the PJM Manual for EMS Model Updates and Quality Assurance (QA).