



BOLD®

Efficiency never looked so good®

ABOUT BOLD®



The logo for BOLD, featuring a white curved line above the word "BOLD" in a bold, sans-serif font. A registered trademark symbol (®) is located to the upper right of the word.



BOLD[®]

(Breakthrough Overhead Line Design[®])

The BOLD Challenge:

- Achieve greater capacity and efficiency at native voltages
 - Avoid series compensation and specialized equipment
 - Increase utilization of existing and future ROW's
- Reduce environmental and visual impacts
- Deliver technology that consumers and regulators desire
- Achieve the above – AND be cost competitive

If we could start from a blank page, what would transmission look like?



BOLD Delivers

- **Higher Capacity & Efficiency**
 - Significantly increases capacity (up to 60%)
 - Avoids complexity and cost of compensation
 - Avoids SSR issues with rotating generation
 - Reduces Line Losses (up to 33%)
- **Environmentally Friendly**
 - Mitigates electromagnetic field effects (up to 50%)
 - Reduces structure heights (as much as 30%)
 - Provides simple, elegant, low-profile design
 - Built-in avian protection features
- **Regulatory Answers**
 - Addresses need for Advanced Transmission Technology
 - More rapidly brings new and replacement circuits into service
 - Maximizes right-of-way utilization
- **BOLD is Cost Competitive**
 - BOLD competes on a first-cost basis
 - BOLD excels on a \$/MW basis



BOLD Survey Summary

Public concerns regarding transmission include property value, health impacts, visual impacts

- **79%** value advanced technology
- **75%** would pay more for advanced technology
- **70%** preferred **BOLD** structures versus traditional double-circuit design

Acceptable monthly premium for advanced technology:

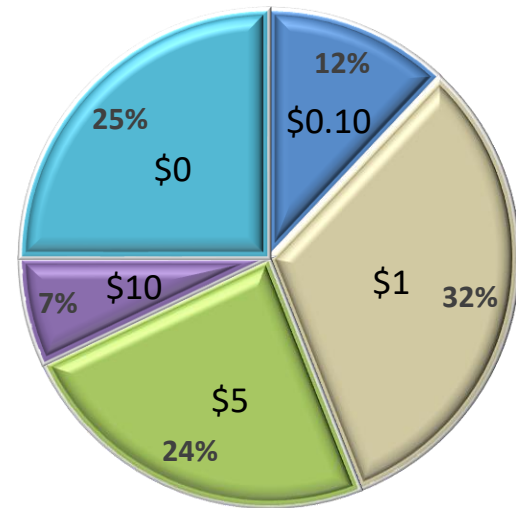

Survey conducted with 1,000 U.S. customers and 500 European customers.



BOLD Award-winning Technology

- 2017 Recipient of Edison Electric Institute's
EDISON AWARD



- 2017 Recipient of NARUC's
INNOVATION IN ELECTRICITY AWARD



- 2017 Grand Prize Recipient of CIGRE/KEPCO's
INTERNATIONAL TOWER DESIGN AWARD





BOLD Project Deployment

as of Aug. 2024

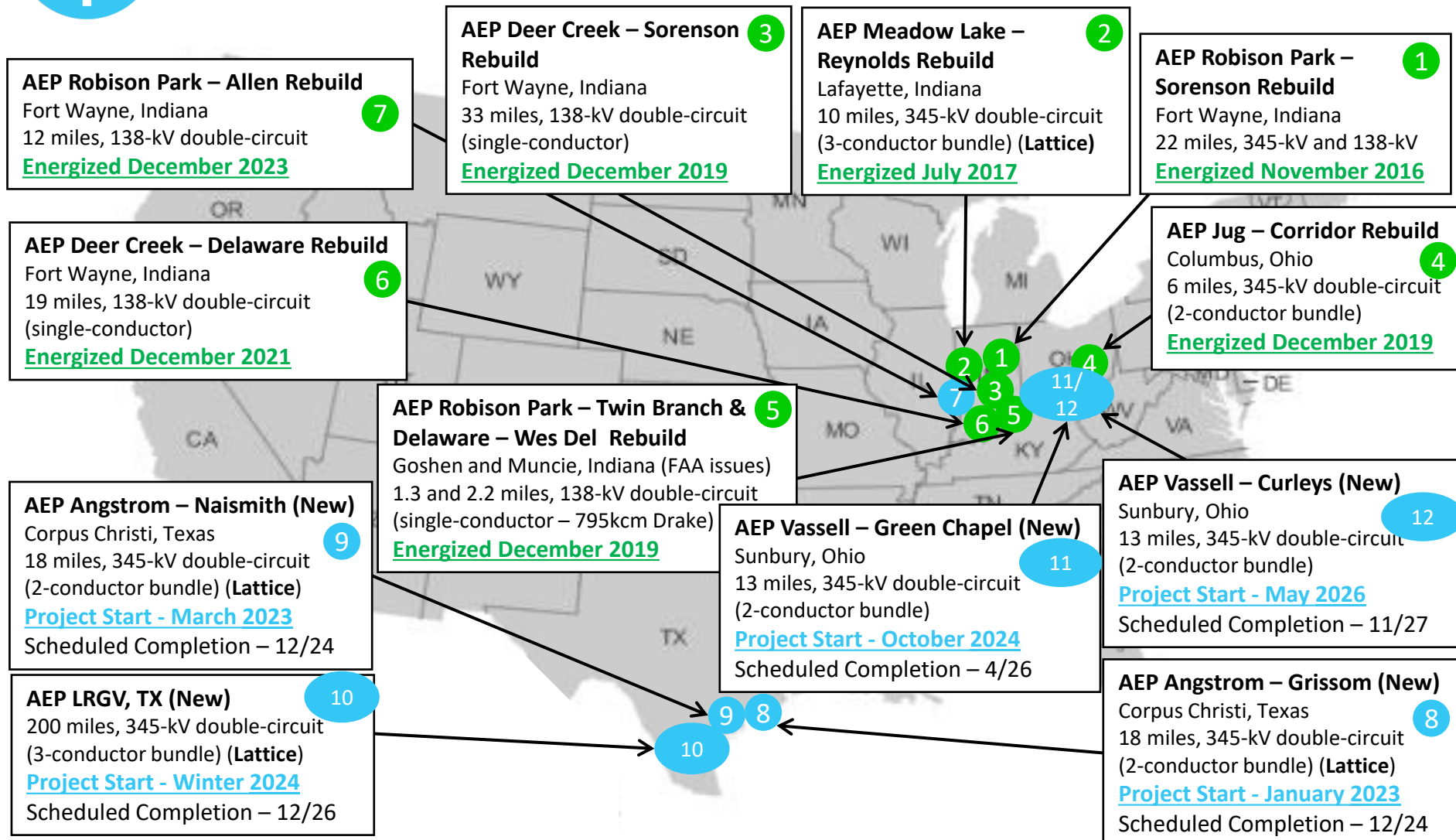

Over 100 miles installed (In Indiana and Ohio), meeting or exceeding design criteria. An additional 250+ miles in construction or design.





HOW IT WORKS

BOLD®



BOLD Development

Surge Impedance changes with $\sqrt{L^+/C^+}$ (ohm)

- $L^+ \approx \frac{\mu_0}{2\pi} \ln\left(\frac{d_{eq}}{R_{eq}}\right) = 0.3219 \ln\left(\frac{d_{eq}}{R_{eq}}\right) \text{ mH/mi}$
- $C^+ \approx \frac{2\pi\epsilon_0}{\ln\left(\frac{d_{eq}}{R_{eq}}\right)} = 89.41 \ln\left(\frac{d_{eq}}{R_{eq}}\right) \text{ nF/mi}$
- $Z^+ \approx 60 \ln\left(\frac{d_{eq}}{R_{eq}}\right) \Omega$
- Where:
 - $d_{eq} = \sqrt[3]{d_{ab}d_{bc}d_{ca}}$ Eq. Phase Spacing (ft)
 - $R_{eq} = \sqrt[3]{NrR^{N-1}}$ Eq. Bundle Radius (ft)
 - d_{ab}, d_{bc}, d_{ca} = Phase spacings (ft)
 - N = Number of subconductors per phase
 - r = Subconductor radius (ft)
 - R = Subconductor bundle radius (ft)

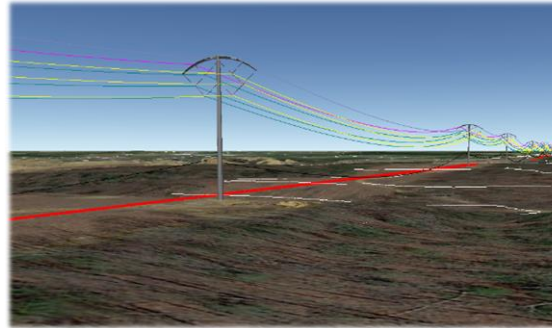

Structural



Electrical

Theory

Modeling

Testing



Field Validation





How BOLD Works

- **Leverage physics to maximize electrical performance:**
 - (1) Reduce phase separation into a “delta” configuration
 - (2) Optimize conductor size and bundle diameter
- **Reduces inductance (L) and impedance (Z) and increases capacitance (C)**
- **Higher degree of intrinsic “self-compensation”**
- **Arched cross arm and inter-phase insulators**

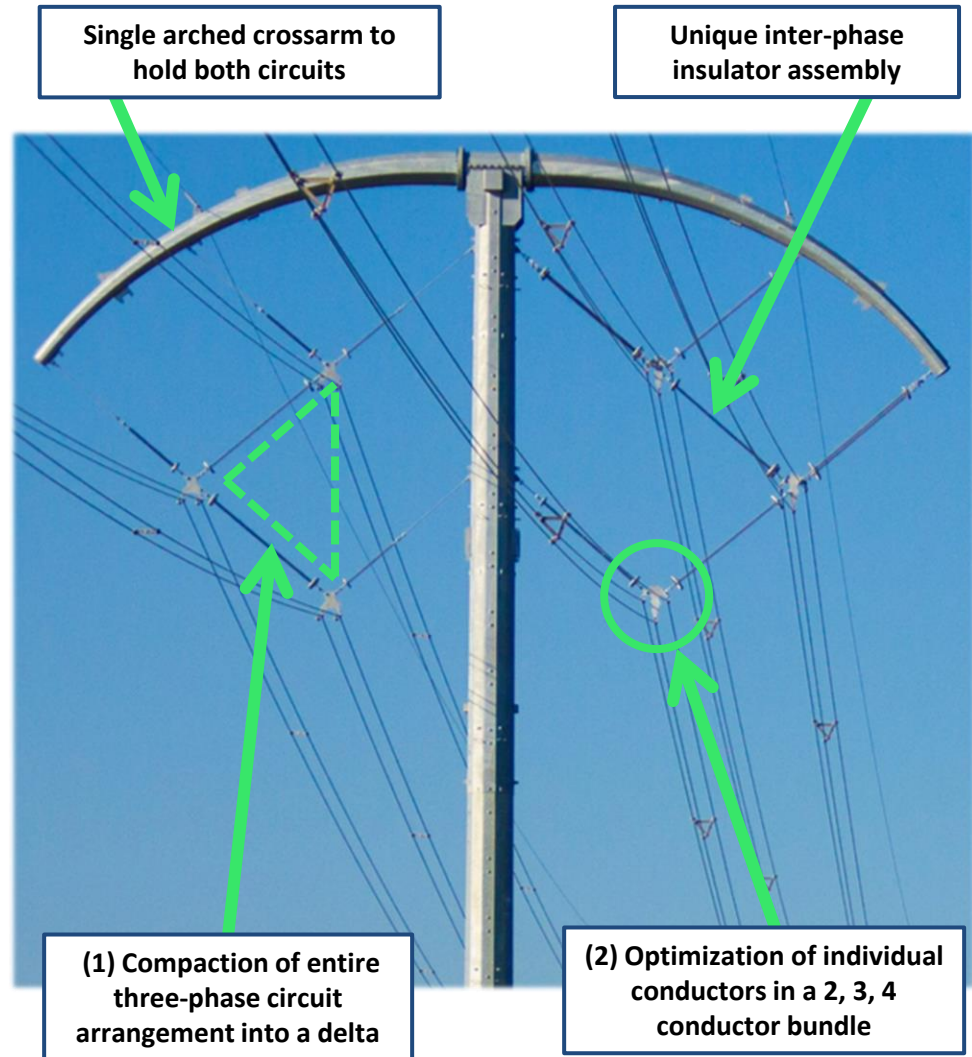



BOLD ADVANTAGE – THE MATH

- Surge Impedance changes with $\sqrt{L^+ / C^+}$ (ohm)

- $L^+ \approx \frac{\mu_0}{2\pi} \ln\left(\frac{d_{eq}}{R_{eq}}\right) = 0.3219 \ln\left(\frac{d_{eq}}{R_{eq}}\right) \text{ mH/mi}$

- $C^+ \approx \frac{2\pi\epsilon_0}{\ln\left(\frac{d_{eq}}{R_{eq}}\right)} = 89.41 / \ln\left(\frac{d_{eq}}{R_{eq}}\right) \text{ nF/mi}$

- $Z^+ \approx 60 \ln\left(\frac{d_{eq}}{R_{eq}}\right) \Omega$

- Where:

- $d_{eq} = \sqrt[3]{d_{ab}d_{bc}d_{ca}}$ **Eq. Phase Spacing (ft)**

- $R_{eq} = \sqrt[N]{NrR^{N-1}}$ **Eq. Bundle Radius (ft)**

- $d_{ab}, d_{bc}, d_{ca} = \text{Phase spacings (ft)}$

- $N = \text{Number of subconductors per phase}$

- $r = \text{Subconductor radius (ft)}$

- $R = \text{Subconductor bundle radius (ft)}$

L, Z decrease; C increases with:

- Closer phase spacing
- More sub-conductors
- Larger bundle diameter
- Larger conductor diameter

BOLD leverages these principles



LINE LOADABILITY BASED ON: SURGE IMPEDANCE LOADING (SIL)

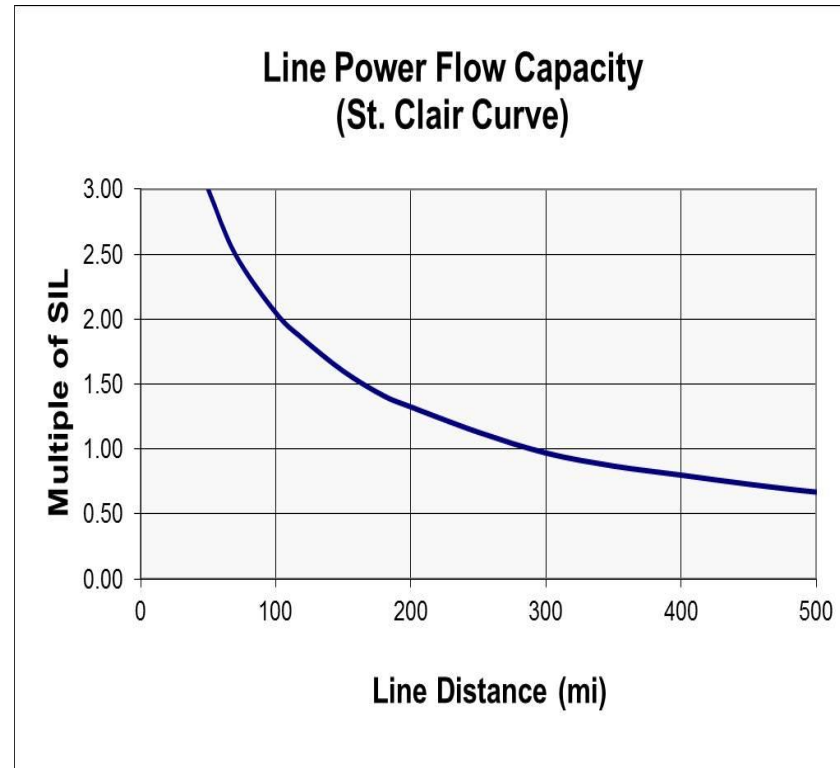

The St. Clair Curve represents a transmission line's power delivery capability over distance without reactive compensation.



EXAMPLE

Meadow Lake – Reynolds 345-kV

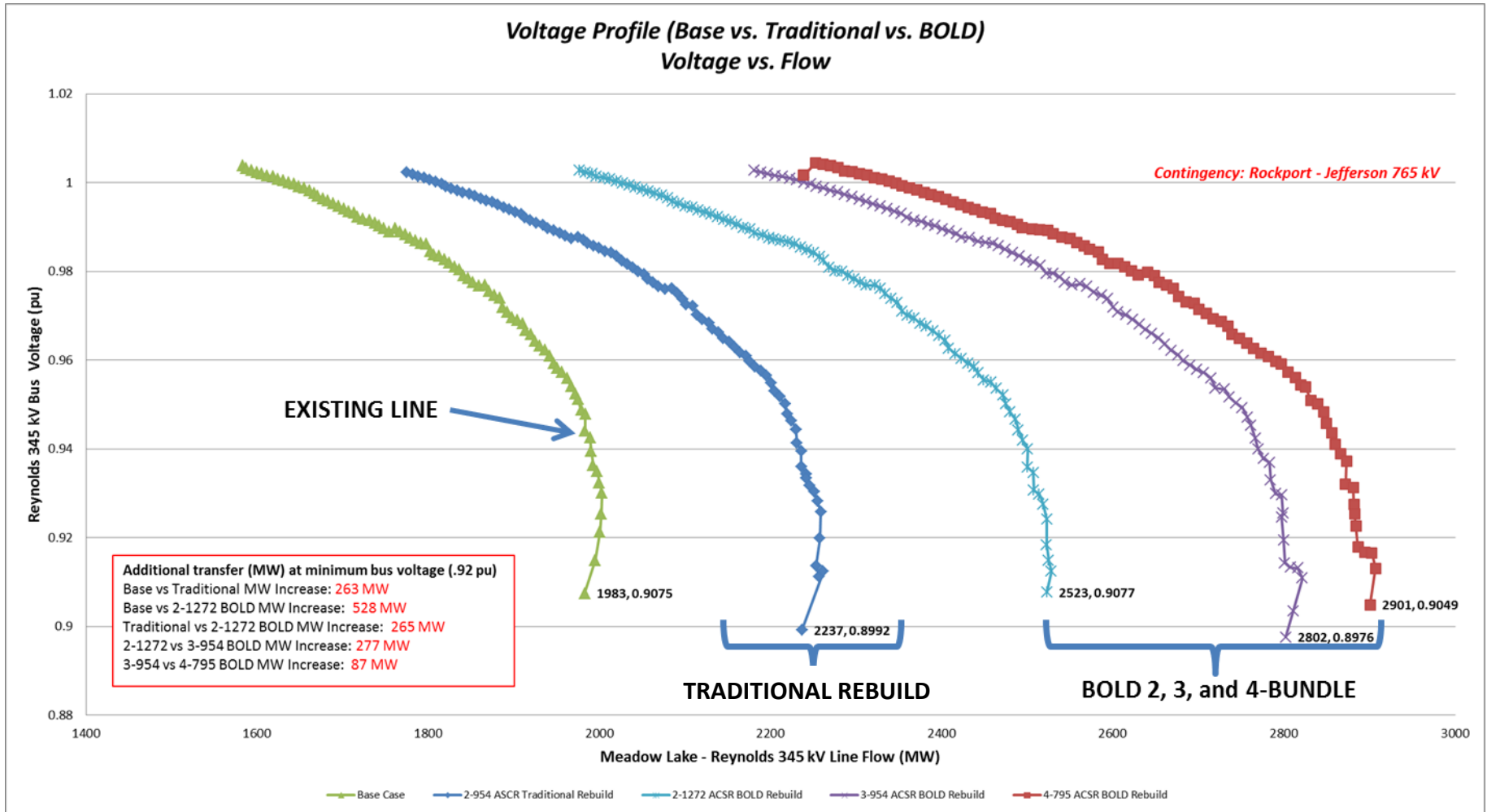



Higher Capacity – 345 kV

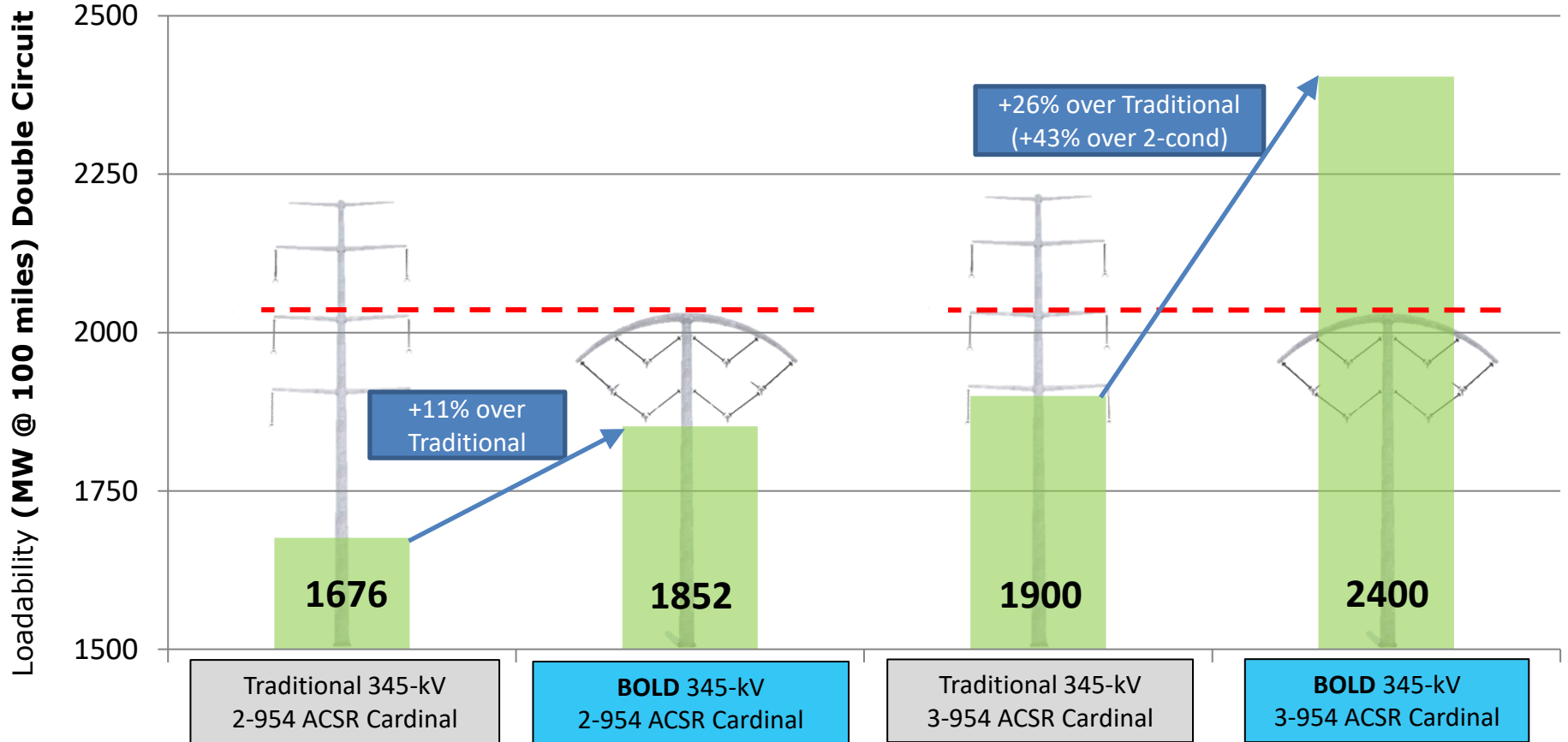

(Values are approximate)



Higher Capacity – 230 kV

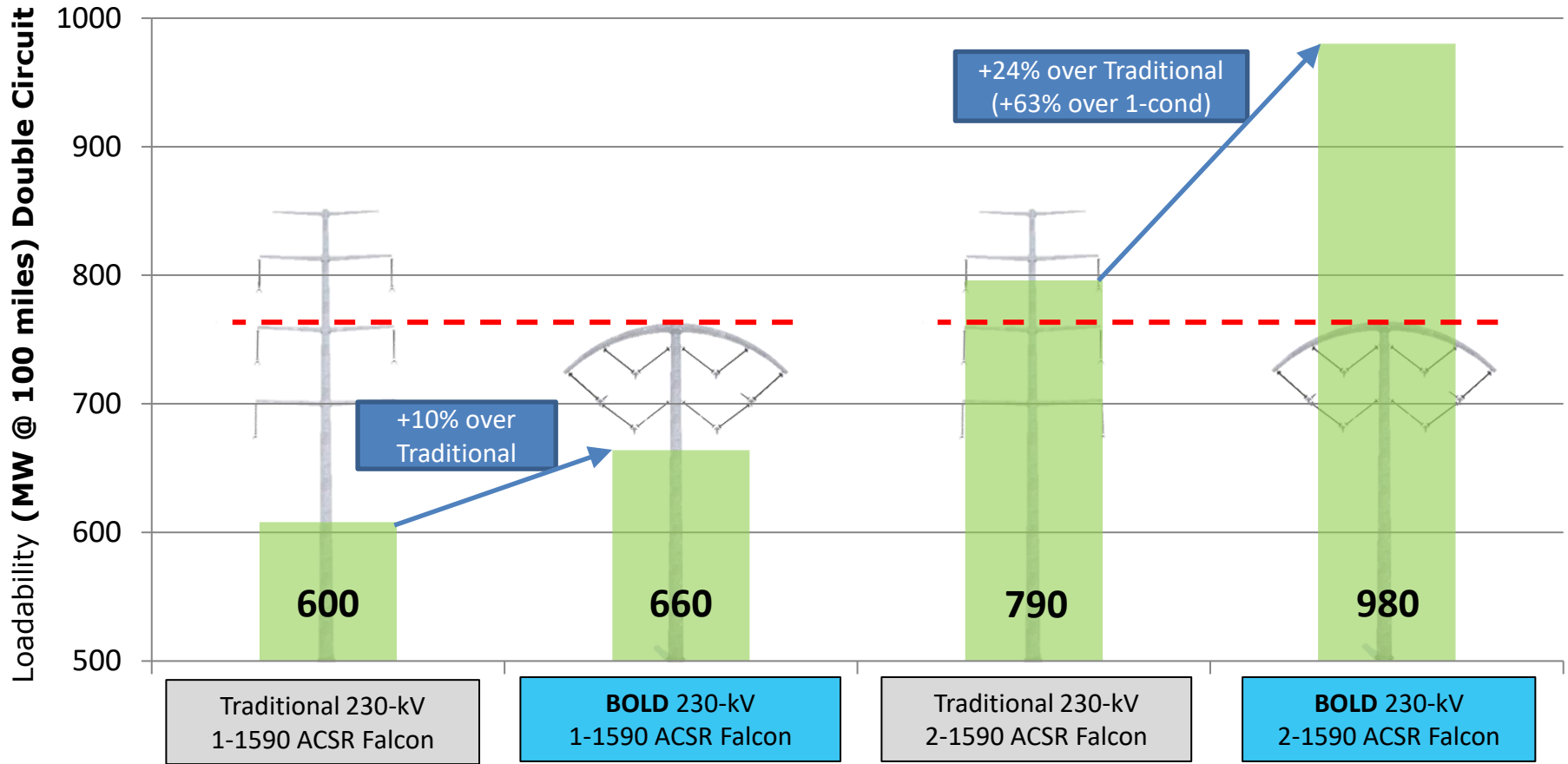

(Values are approximate)



SIL Comparisons



765kV Single-circuit
(6-conductor)

~2,400 MW

200' ROW



345kV **BOLD** Double-circuit
(3-conductor)

~1,200 MW

150' ROW



345kV Traditional Double-circuit
(3-conductor)

~950 MW

345kV Traditional Double-circuit
(2-conductor)

~850 MW

150' ROW



500kV Single-circuit
(3-conductor)

~950 MW

175' ROW

BOLD is a relevant option for long-haul power Transmission





Better Use of RoW

BOLD allows you to deliver **more** power in a given right-of-way when compared to traditional transmission line designs. That means less land is needed to fulfill capacity needs.

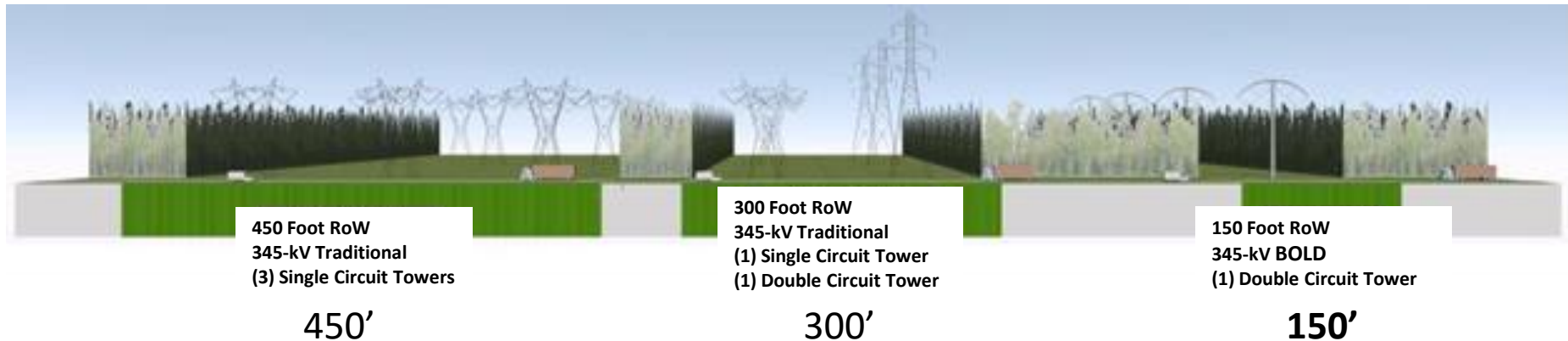

One **BOLD** 345-kV double-circuit line can deliver the same power carrying capacity as three traditional 345-kV single-circuit lines creating a smaller environmental footprint of roughly 1/3 by comparison





Magnetic Field Mitigation

Traditional 345-kV

Magnetic Field Profile @1000MVA Per Circuit
Traditional 345-kV 2-Falcon 25.5ft Phase Spacing 18" Bundle Diameter
Super Bundle Arrangement (A-B-C / A-B-C)

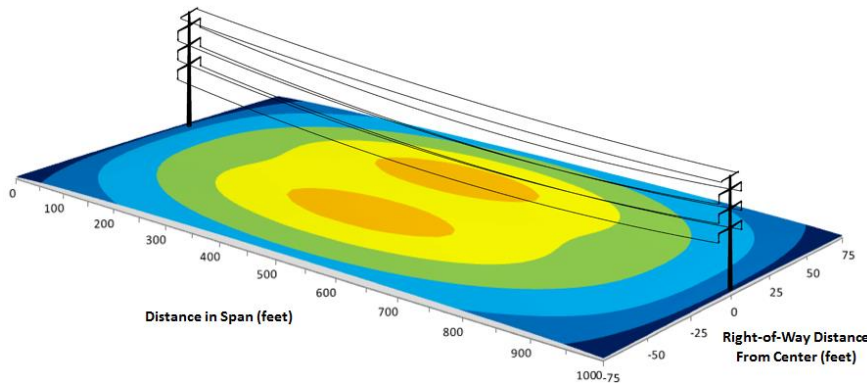

Min = 34.5 mG
Max = 193.4 mG

BOLD 345-kV

Magnetic Field Profile @1000MVA Per Circuit
BOLD 345-kV 3-Cardinal 15ft Phase Spacing 29" Bundle Diameter
Super Bundle Arrangement (A-B-C / A-B-C)

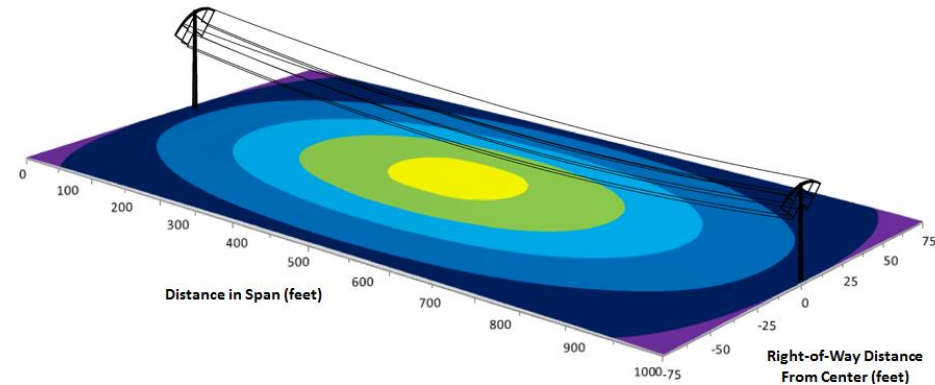

Min = 16.2 mG
Max = 157.6 mG

Magnetic Field Intensity (mG)

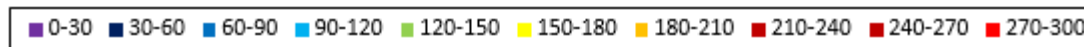

1000' Span Lengths

BOLD reduces Magnetic Field values by up to 50%!



Structure Comparison – 345 kV

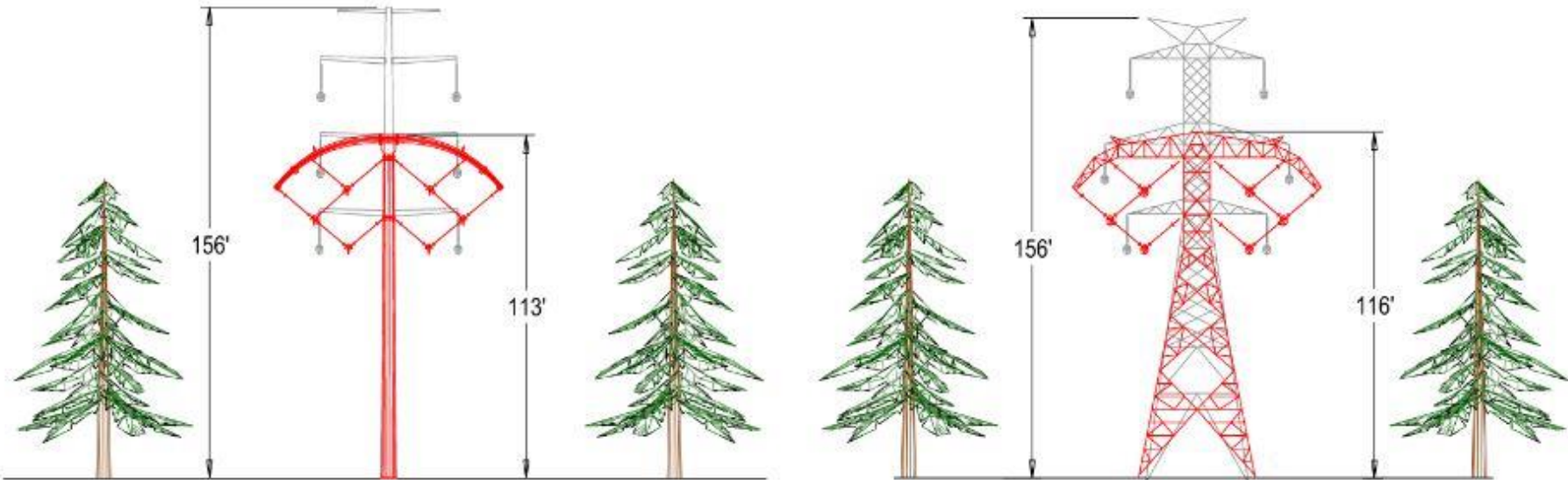

1000' Span Lengths



Structure Comparison – 230 kV

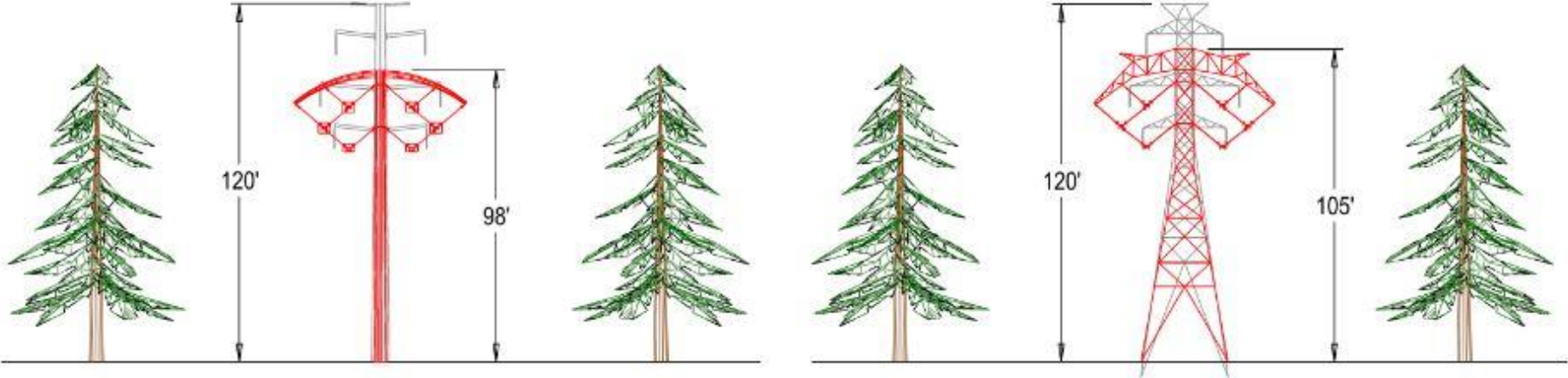

1000' Span Lengths



BOLD Reduces Avian Interaction*

- **Nesting**
 - **BOLD** eliminates cavity nests and should minimize corvid and raptor stick nests due to the unique arch-shaped cross member.
- **Collision**
 - **BOLD** has design elements to reduce collision risk
- **Feces**
 - **BOLD** should reduce pollution outages by limiting perching and creating a barrier; it may also reduce streamer outages.
- **Predation Management**
 - **BOLD** may minimize avian predation on sensitive species by reducing nesting on transmission structures.
- **Electrocution**
 - **BOLD** can be implemented as eagle friendly



* Source: EDM International, Inc. study (2018)

BOLD STRUCTURE FAMILY

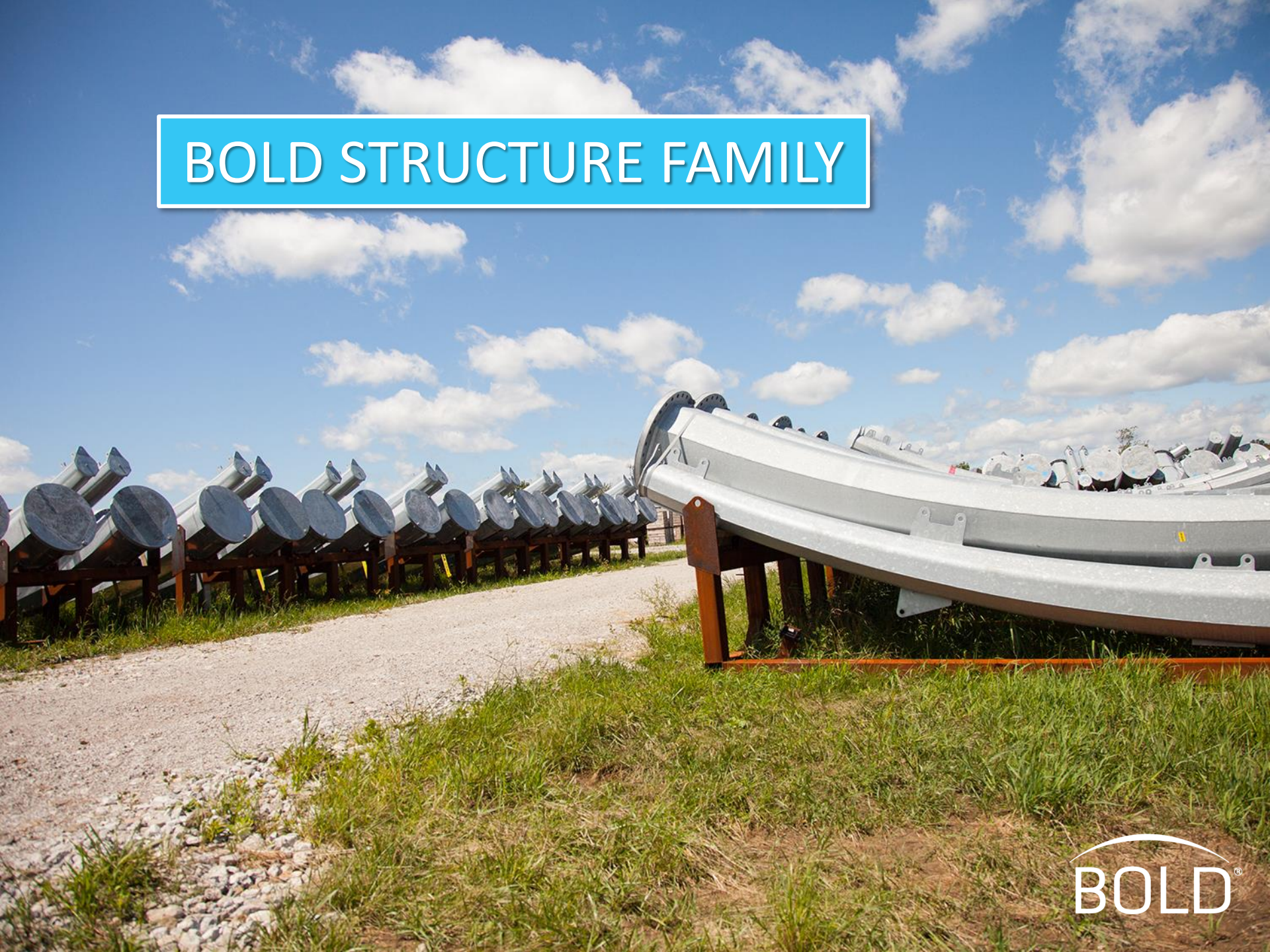



BOLD Structure Families

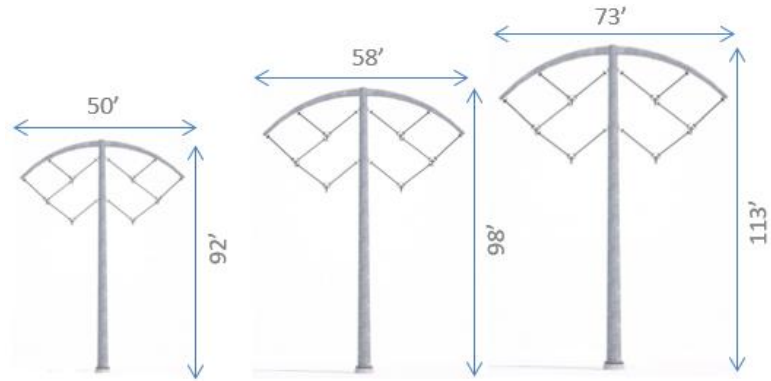

OPTIONS	115/138-kV	230-kV	345-kV
Single Circuit	✓	✓	✓
Double Circuit	✓	✓	✓
Various Conductor Options	✓	✓	✓

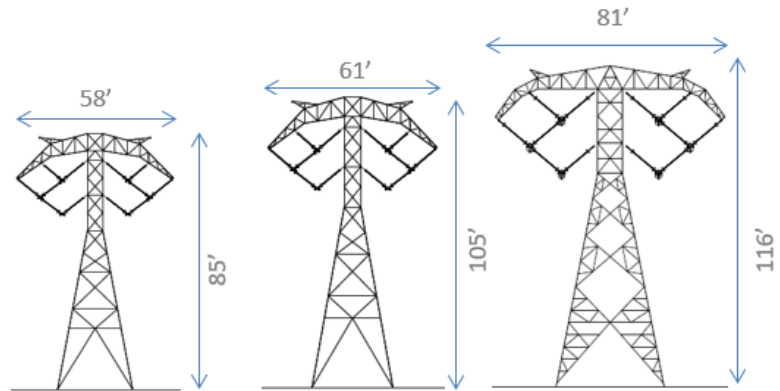

1000' Span Lengths



BOLD Conductor Options

	3-954 BOLD Lattice	3-954 Traditional Lattice	2-1590 BOLD Lattice	2-1590 Traditional Lattice	2-954 BOLD Lattice	2-954 Traditional Lattice
Average Line Cost* (\$/mile)	100%	105%	97%	102%	87%	92%
Tangent Structure Weight (lbs.)	100%	118%	95%	108%	85%	97%
Foundation (cu. yd)	100%	106%	97%	103%	91%	97%
Impedance (Ω)	100%	+127%	+122%	+136%	+130%	+145%

*Indicative cost comparison, using common assumptions and unit pricing.



BOLD is the optimal design for cost and impedance.



A Cost Competitive **BOLD** Solution

Traditional

Pole Weight	36,600 lbs
Arm Weight	10,378 lbs
GL Moment	6,000 ft-K
Foundation Size	6.5 ft x 25ft

Pole Cost	100%
Arm Cost	100%
Anchor B Cost	100%
<u>Foundation Cost</u>	<u>100%</u>
Total Cost	100%

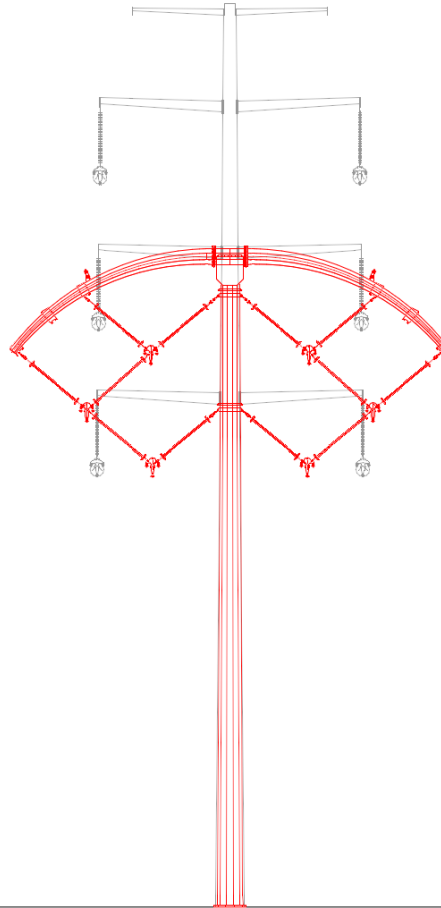

BOLD

Pole Weight	33,098 lbs
Arm Weight	11,070 lbs
GL Moment	4,600 ft-K
Foundation Size	6 ft x 22 ft

Pole Cost	90%
Arm Cost	157%
Anchor B Cost	60%
<u>Foundation Cost</u>	<u>75%</u>
Total Cost	99%

Typical 345-kV Tangent Structure

2-1590 ACSR Falcon



A Cost Competitive **BOLD** Solution

Traditional

Pole Weight	42,100 lbs
Arm Weight	10,500 lbs
GL Moment	6,150 ft-K
Foundation Size	6.5 ft x 25ft

Pole Cost	100%
Arm Cost	100%
Anchor B Cost	100%
<u>Foundation Cost</u>	<u>100%</u>
Total Cost	100%

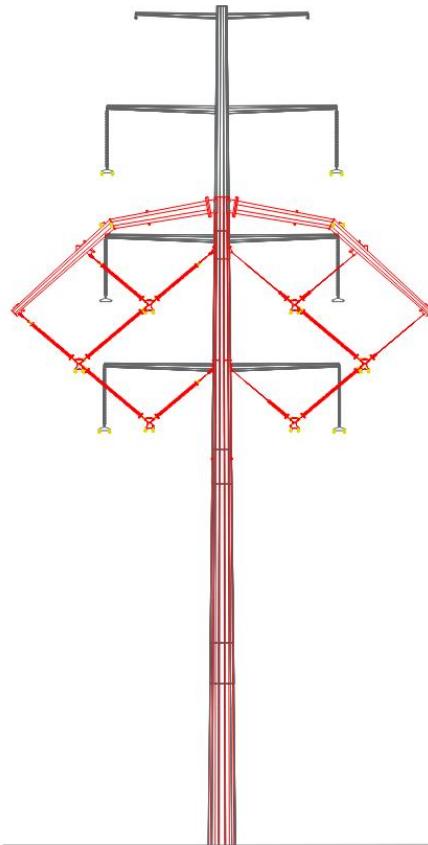

BOLD

Pole Weight	33,700 lbs
Arm Weight	11,100 lbs
GL Moment	4,650 ft-K
Foundation Size	6.0 ft x 22 ft

Pole Cost	82%
Arm Cost	132%
Anchor B Cost	82%
<u>Foundation Cost</u>	<u>75%</u>
Total Cost	93%

Typical 345-kV Tangent Structure

2-1590 ACSR Falcon

Span Length: 1100'

NESC Medium



A Cost Competitive **BOLD** Solution

Traditional

Tower Weight 31,000 lbs
Uplift force 114 kips
Foundation Size 4.0 ft x 13ft

Tower Cost 100%
Foundation Cost 100%
Total Cost 100%

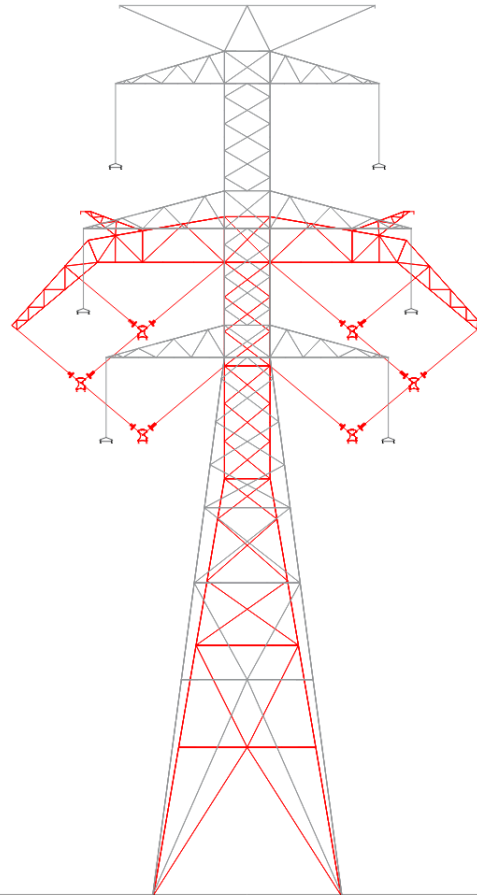

BOLD

Tower Weight 25,700 lbs
Uplift force 94 kips
Foundation Size 4.0 ft x 12ft

Tower Cost 82%
Foundation Cost 92%
Total Cost 86%

Typical 345-kV Tangent Structure

2-1590 ACSR Falcon

Span Length: 1200'

NESC Medium



BENEFITS

BOLD[®]



BOLD Benefits Summary





BOLD Benefits Summary

Higher Capacity

- Up to 60%
- Can avoid costly and complex compensation



BOLD Benefits Summary

Higher Capacity

- Up to 60%
- Can avoid costly and complex compensation

Increased Efficiency

- Reduces Line Losses (up to 33%)



BOLD Benefits Summary

Mitigates EMF Effects

- Up to 50%

Higher Capacity

- Up to 60%
- Can avoid costly and complex compensation

Increased Efficiency

- Reduces Line Losses (up to 33%)



BOLD Benefits Summary

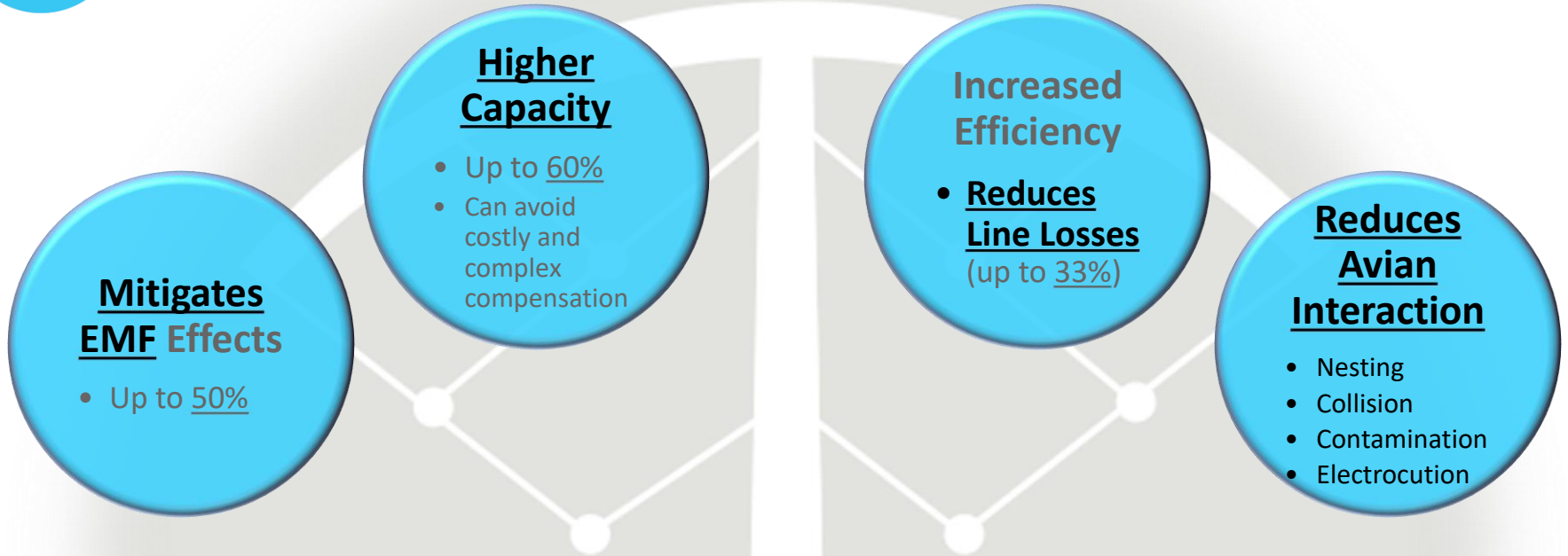



BOLD Benefits Summary

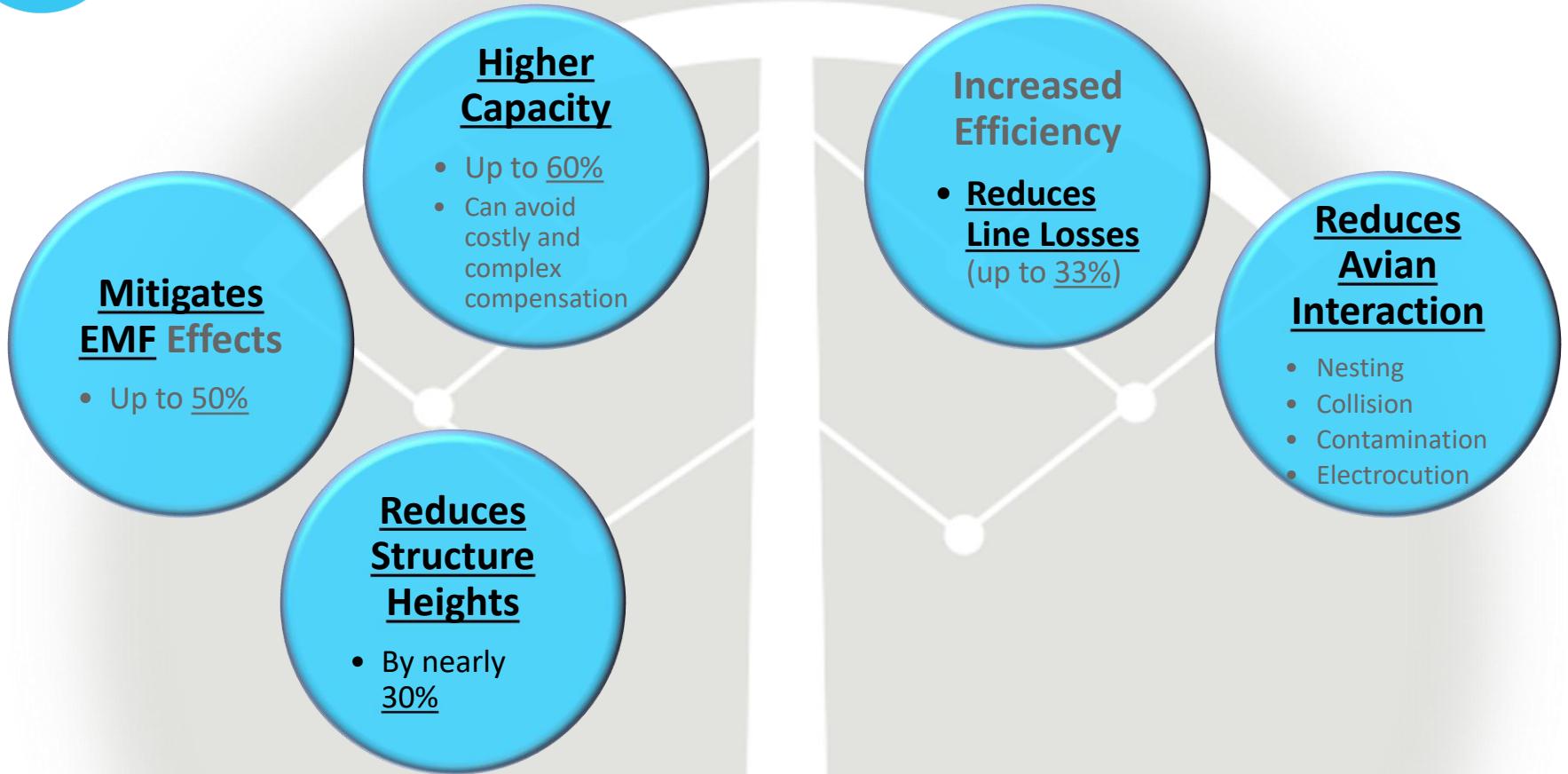



BOLD Benefits Summary

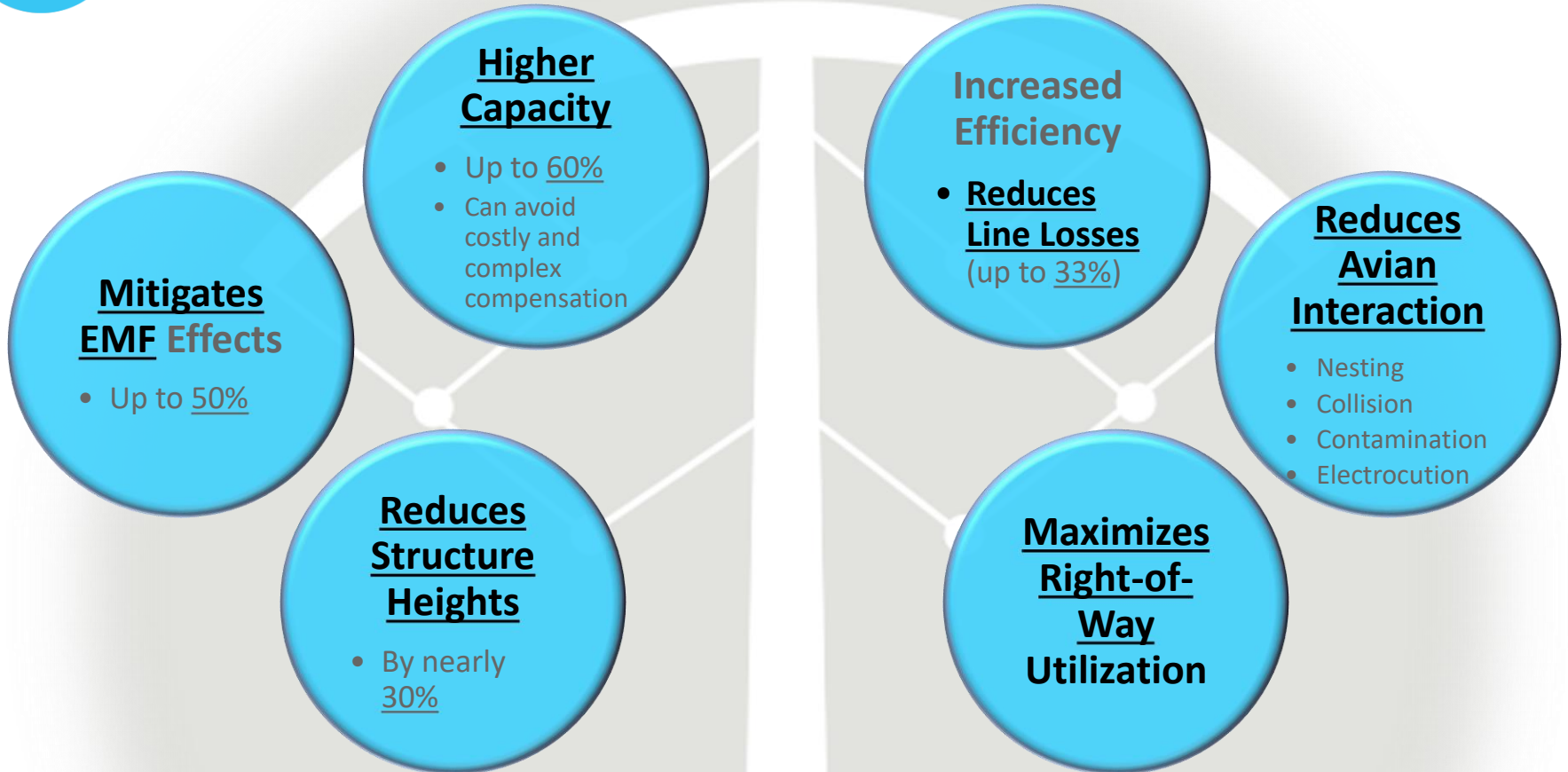



BOLD Benefits Summary

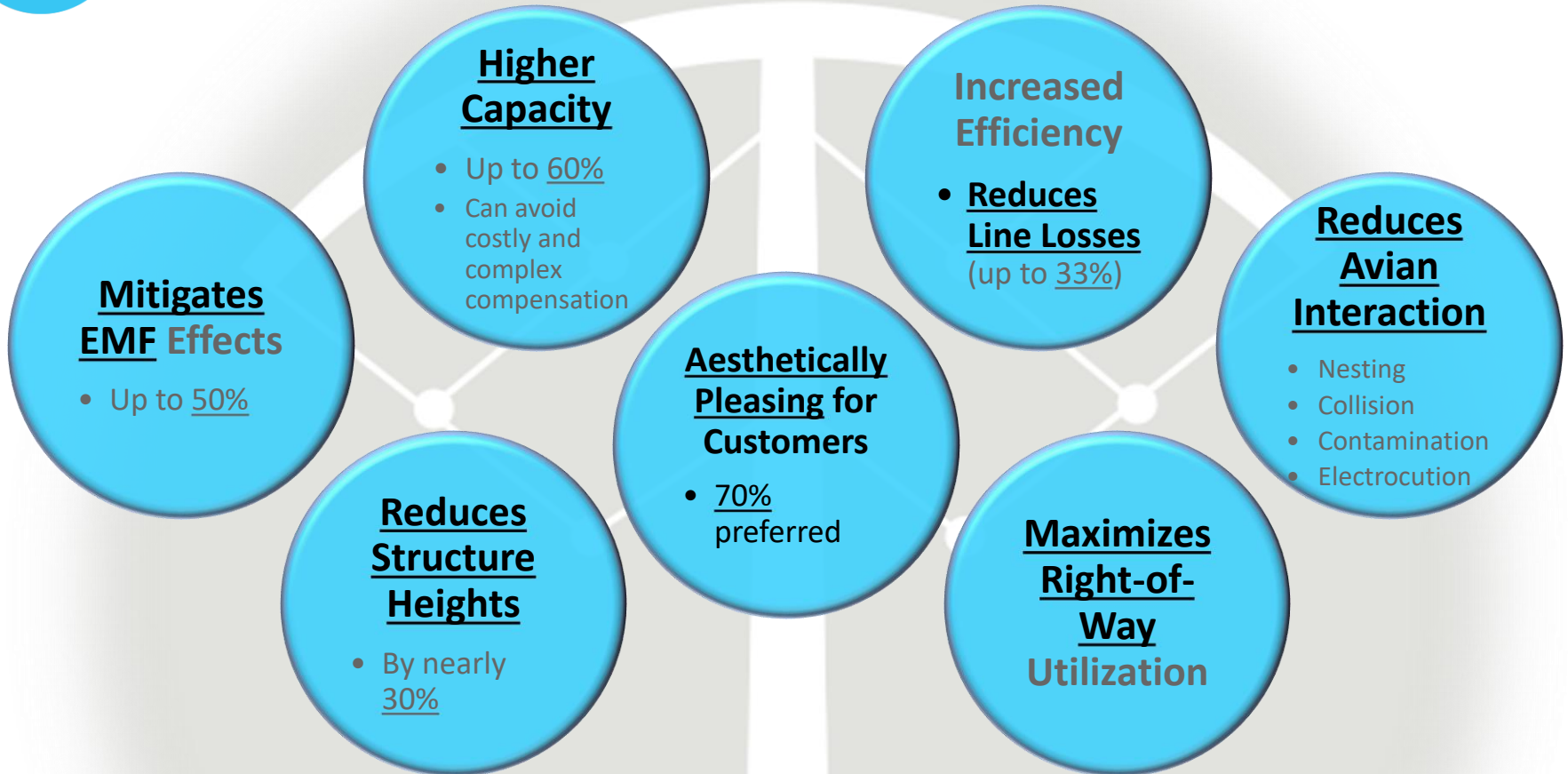



BOLD Benefits Summary

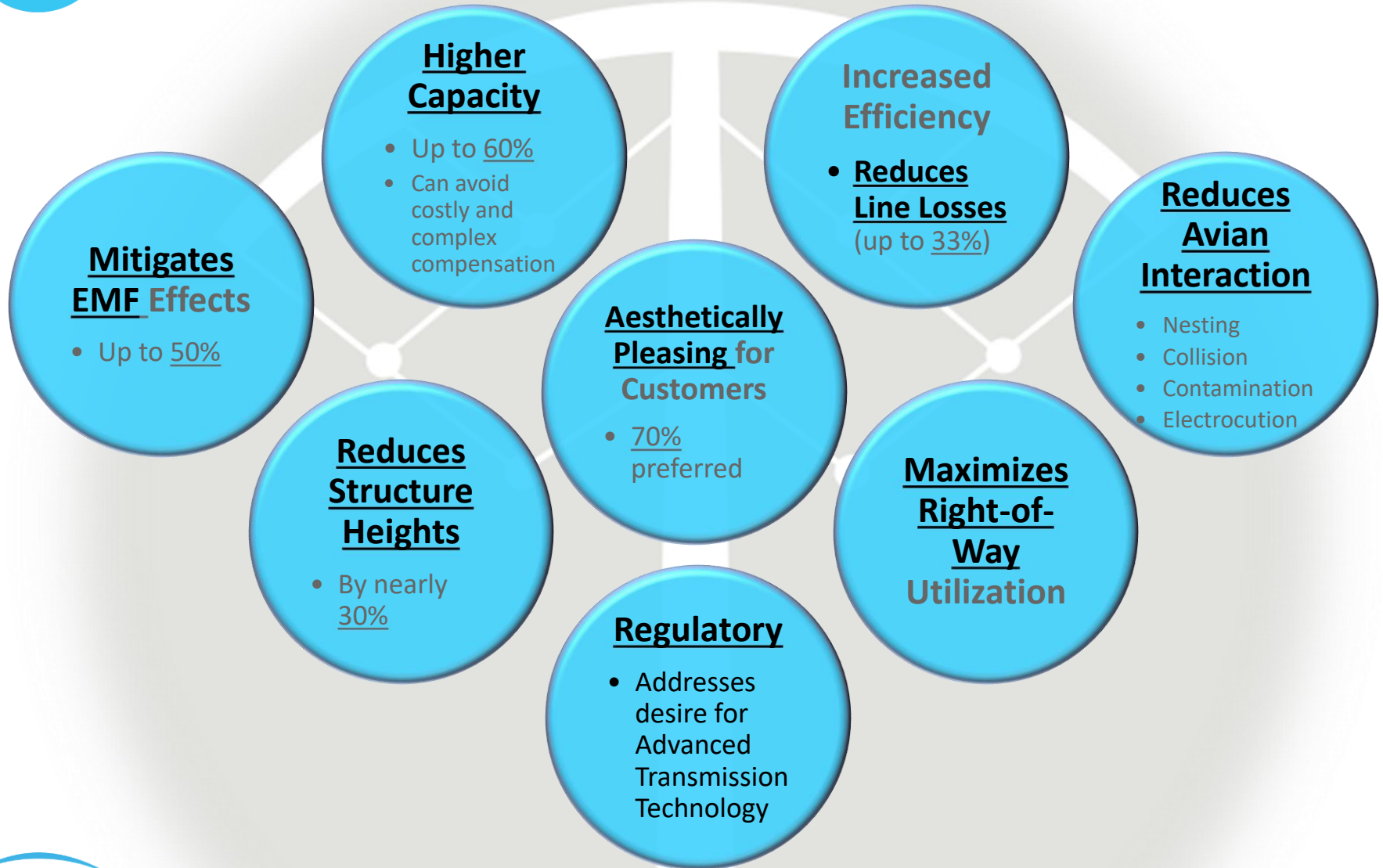



BOLD Benefits Summary

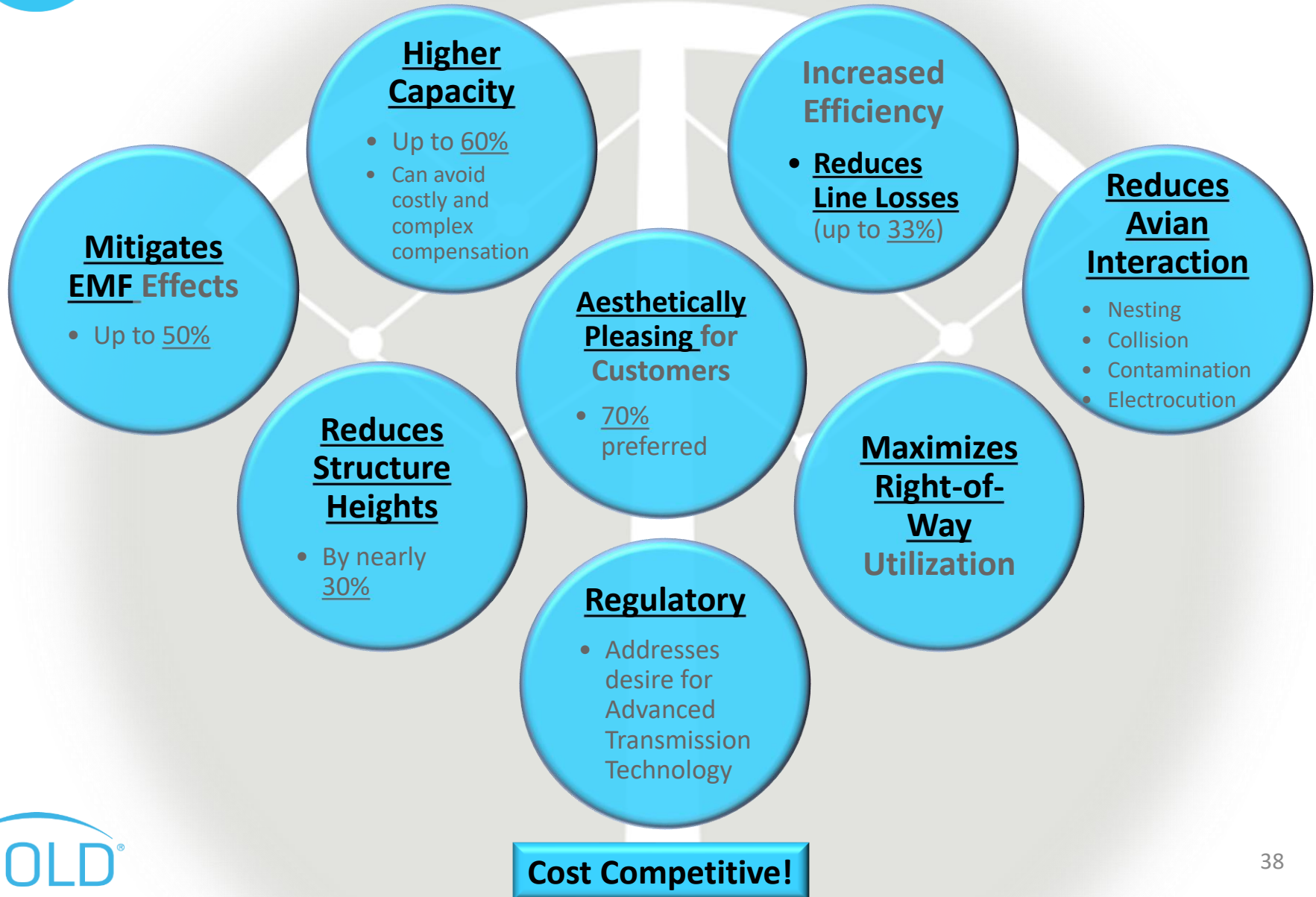



Efficiency never looked so good.®

Presentation to PJM TEAC – Special Session, Order 1920
September 6, 2024

Thank You!

David E. Rupert
President & CEO
1 Riverside Plaza
Columbus, OH 43215

614-716-2529 (office)
614-302-8297 (cell)
derupert@aep.com
vimeo.com/boldtransmission

Learn more at: BOLDTransmission.com

