

Transmission Expansion Advisory Committee: AEP Supplemental Projects

December 5, 2023

Solutions

Stakeholders must submit any comments within 10 days of this meeting in order to provide time necessary to consider these comments prior to the next phase of the M-3 process

Process Stage: Solutions Meeting 5/9/2023, 12/5/2023

Reason for review:

In March 2023, AEP informed stakeholders of its intent to acquire ROW for two 345 kV transmission lines to New Albany in recognition of the interest AEP has received in the area. AEP is now coming back to recommend the supplemental build of these lines to address the amount of load that has signed an LOA. PJM has confirmed in its DNH analysis that these lines do not cause other issues and address the build out of the loads in the area.

Need Number: AEP-2022-OH071

Process Stage: Solution Meeting 5/9/2023, 12/5/2023

Previously Presented: Need Meeting 10/14/2022

Project Driver: Customer Service

Specific Assumption Reference:

AEP Guidelines for Transmission Owner Identified Needs (AEP Assumptions Slide 13)

Problem Statement:

- A customer has requested additional 138 kV deliveries to their site in Columbus, Ohio near AEP's proposed Cyprus station (s2526).
- The initial peak demand at these new delivery points will be approximately 200 MW and the ultimate capacity of the customer will be up to 675 MW at the site.



Need Number: AEP-2022-OH071

Process Stage: Solutions Meeting 5/9/2023, 12/5/2023

Proposed Solution:

The following work is all direct connect facilities to physically connect demand to the grid.

- **Cyprus 345/138 kV:** Cyprus is the station that was originally developed (s2526) to serve 675 MW of demand with room for 345 kV expansion based on LOA with the customer. Cut into the Beatty – Bixby 345 kV circuit and construct ~1.6 miles of double circuit line, utilizing 2-bundled ACSR Bittern 1272 conductor, SE rating 2278 MVA, to a new 345 kV ring bus at Cyprus station with (4) 5000 A, 63kA circuit breakers, (2) 345/138/34.5 kV, 675 MVA transformers, (12) 4000 A, 63kA, 138 kV circuit breakers, (1) 69.1 MVAR 138 kV Cap bank. Construct (2) 138 kV single circuit, ~0.4 miles, & (2) double circuit, ~0.9 miles, tie lines to the customers dead end structures utilizing ACSR Drake 795 (26/7) conductor SE 360 MVA. Modify the existing Cyprus 138kV Extension & Parsons 138kV circuits #1 & 2 structures to accommodate a fence relocation. Remote end relay upgrades are required at Beatty & Bixby 345 kV stations. Cost: **\$46.9 M (Projected ISD : 11/13/2024)**
- **Parsons 138 kV:** Install (1) 69.1 MVAR cap bank to resolve N-1-1 voltage issues. Cost: **\$2.0 M (Projected ISD : 7/24/2025)**

AEP Transmission Zone M-3 Process South Columbus, OH



Need Number: AEP-2022-OH071

Process Stage: Solutions Meeting 5/9/2023, 12/5/2023

Proposed Solution:

The following components are system reinforcements required to serve the load and meet applicable TPL-001, PJM, and AEP planning criteria:

- **Beatty – Canal 138 kV line Sag Re-rate:** The Beatty – Canal 138 kV line flagged as overloading under N-1-1 scenarios after the addition of the new load at Cyprus. The line will be flown to address sag issues that are limiting its current rating. It is anticipated that several structures will need to be replaced in order to raise the rating of the line. Cost: **\$5.5 M (Projected ISD : 7/24/2025)**
- **Waverly Reactor 138 kV:** Install a 4% series reactor towards Rozelle at Waverly station to address a N-1-0 scenario related to the loss of a nearby 345 kV line. Cost: **\$3.0 M (Projected ISD : 12/1/2026)**
- **Saint Clair Avenue Reactor 138 kV:** Adjust tap settings on reactors towards Mound and Clinton stations to 3%. Cost: **\$0.0 M (Projected ISD : 12/1/2026)**
- **Marion Station:** Replace switch and line riser at Marion station towards Obetz to address loading concern under certain N-1-1 scenario related to customer interconnections in the area. **\$0.1M (Projected ISD : 12/1/2027)**

System Upgrades: \$8.6M

Direct Connect Facilities: \$48.9M

Total Estimated Transmission Cost: \$57.5M

Existing:

Legend	
765 kV	
345 kV	
138 kV	
69 kV	
34.5 kV	
23 kV	
New	

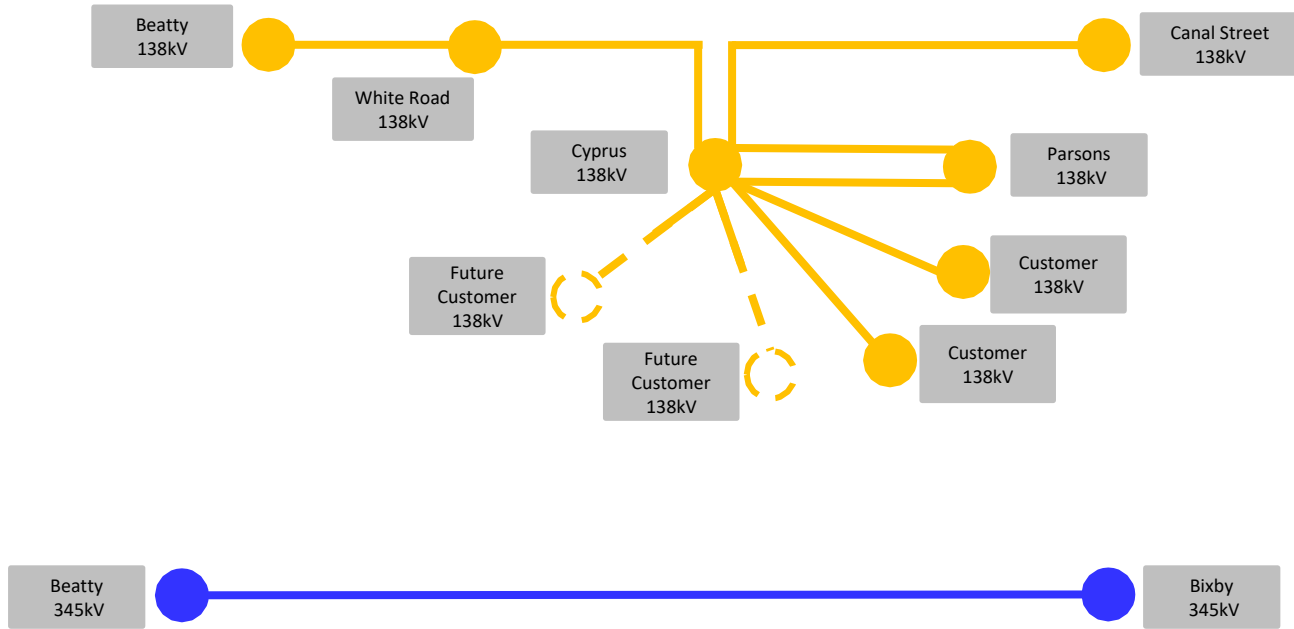

Proposed:

Legend	
765 kV	
345 kV	
138 kV	
69 kV	
34.5 kV	
23 kV	
New	

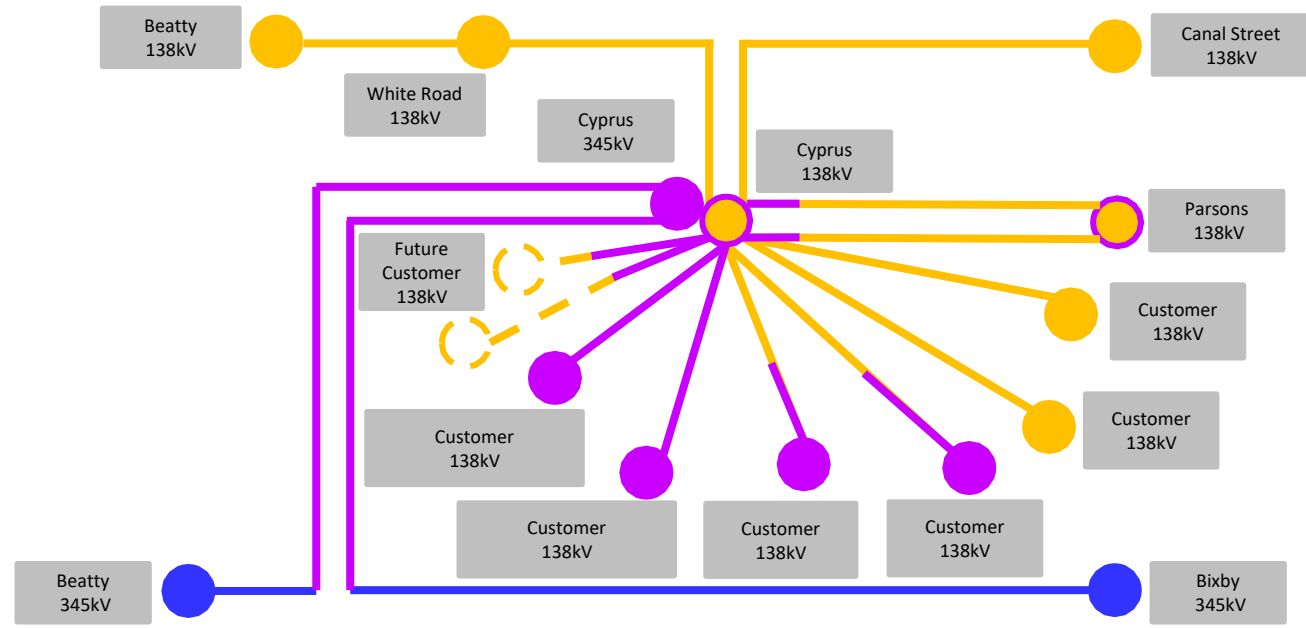

AEP Transmission Zone M-3 Process Jerome

Need Number: AEP-2021-OH049

Process Stage: Solution Meeting 5/9/2023, 12/5/2023

Previously Presented: Needs Meeting 7/16/2021, Need Meeting 9/17/2021 & Need Meeting 2/17/2023

Project Driver: Customer Service

Specific Assumption Reference: AEP Connection Requirements for the AEP Transmission System (AEP Assumptions Slide 12)

Problem Statement:

Jerome Delivery Point (AEP) 138 kV:

- A customer has requested new transmission service in Plain City, Ohio.
- The delivery point will be used to serve a customer with high potential for rapid load growth. The initial load will be 106 MW with a potential future peak load demand of 203 MW.
- Service is requested by June 2024.
- The customer communicated a much more aggressive load ramp/build out schedule that would put their peak load at approximately 160 MW by early 2025 at the site.
- This Need was originally presented as a Buckeye Power request; The customer has since requested service from AEP Ohio at the site. As part of this request, the customer has indicated the need for additional feeds at the delivery which will bring the load amount up to 203 MW.

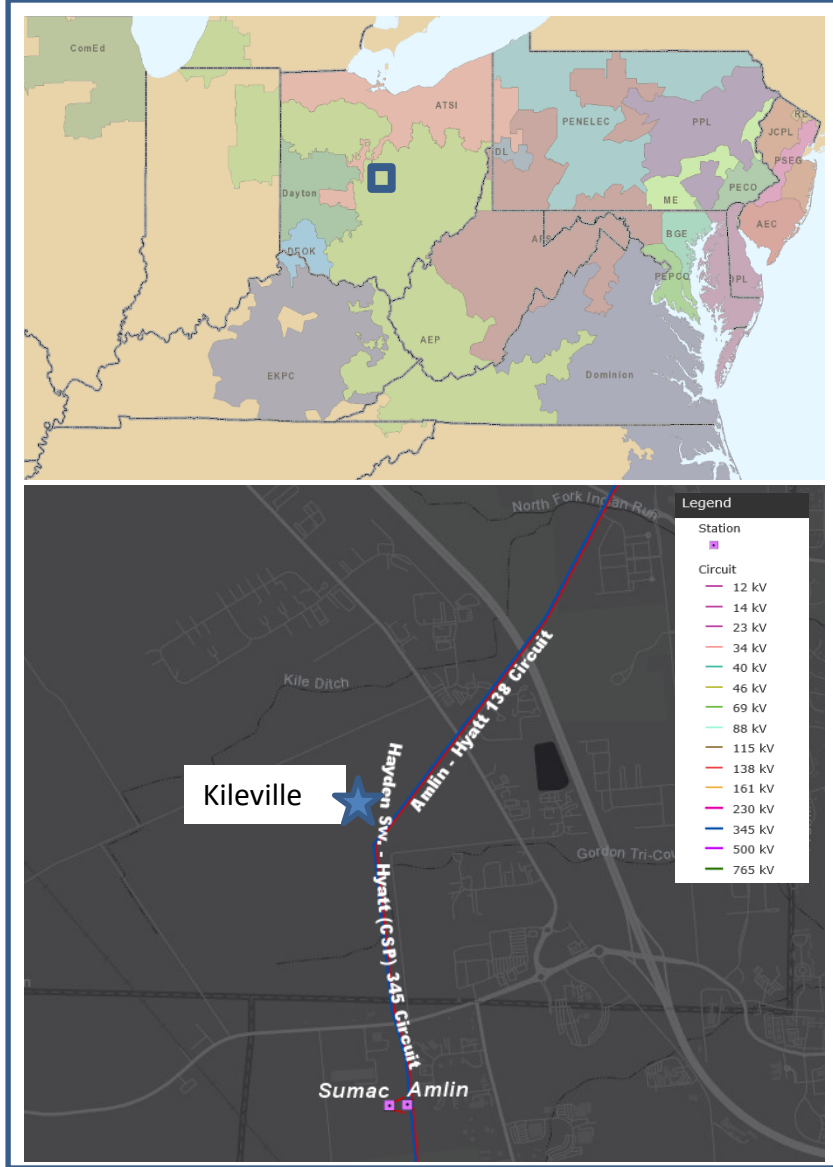

Need Number: AEP-2021-OH049

Process Stage: Solutions Meeting 5/9/2023, 12/5/2023

Proposed Solution:

The following scope of work is all direct connect facilities to physically connect demand to the grid.

- **Jerome 138 kV:** Construct a greenfield Jerome station with (11) 138kV 63kA 4000A circuit breakers in breaker and half bus configuration. Construct ~ 2.5 miles of double circuit 138kV transmission line extending from Celtic & Kileville stations utilizing 2-bundled ACSS Cardinal 954 (45/7) conductor, SE rating 1061 MVA. Construct ~1.6 miles of double circuit 138kV transmission line extending from Jerome to cut-in back to Hyatt – Amlin line utilizing 2-bundled ACSS Cardinal 954 (45/7) conductor, SE rating 1061 MVA. Construct (4) 138 kV tie lines to the customers dead end structures ~0.05 miles utilizing ACSR Dove 556.5 (26/7) conductor SE 284 MVA. Customers will be directly connected at this station. Cost: **\$30 M (Projected ISD : 6/1/2024)**

Need Number: AEP-2022-OH024

Process Stage: Solutions Meeting 5/9/2023, 12/5/2023

Previously Presented: Need Meeting 2/18/2022

Project Driver: Customer Service

Specific Assumption Reference:

AEP Connection Requirements for the AEP Transmission System (AEP Assumptions Slide 12)

Problem Statement:

Customer Service:

- A customer has requested transmission service at a site North of AEP's existing Roberts station in Columbus, OH.
- The customer has indicated an initial peak demand of 125 MW with an ultimate capacity of up to 328 MW at the site.
- Initial customer requested in-service date of June 1, 2024.

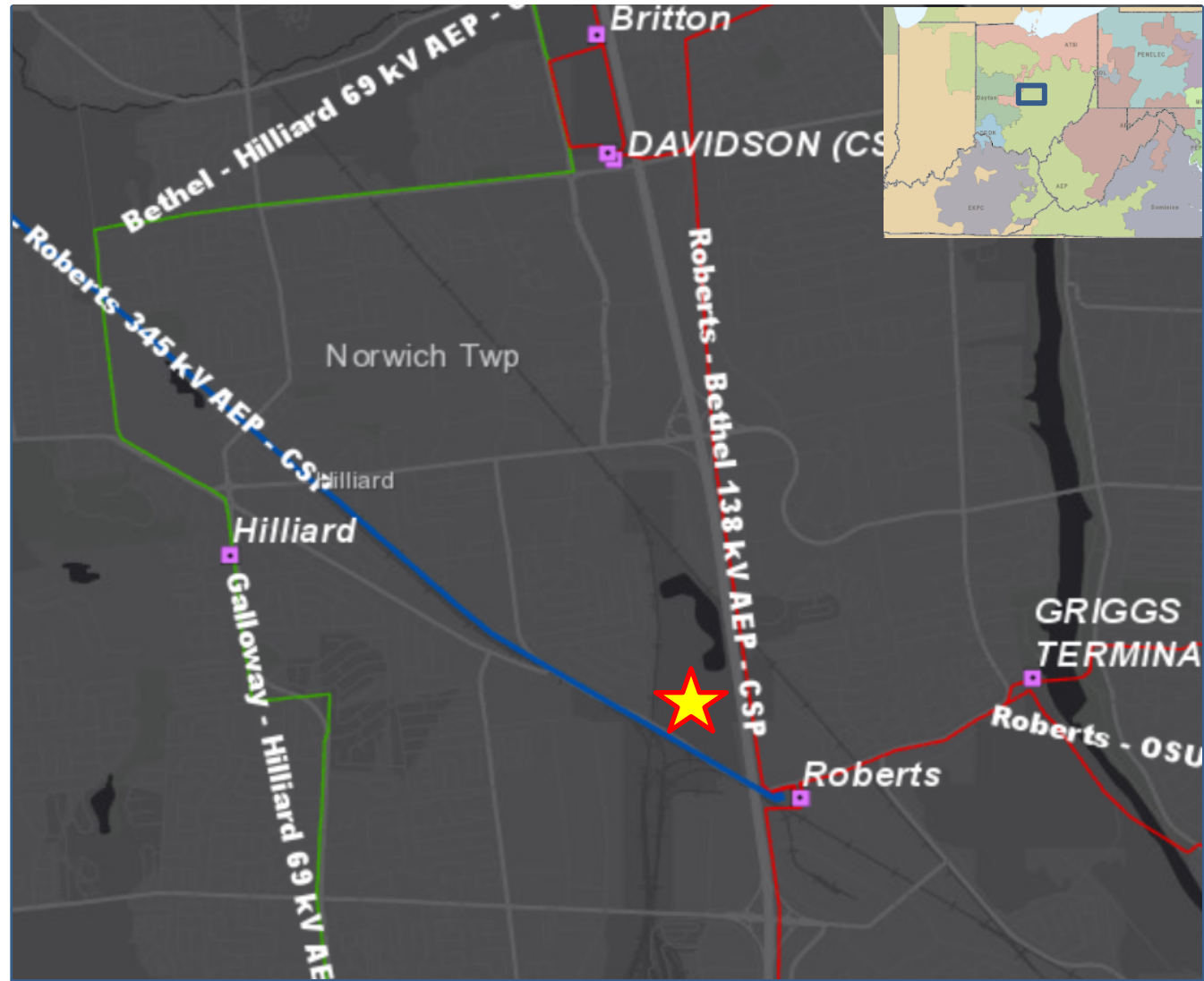

Need Number: AEP-2022-OH024

Process Stage: Solutions Meeting 5/9/2023, 12/5/2023

Proposed Solution:

The following scope of work is all direct connect facilities to physically connect demand to the grid.

- **Beacon 345 kV:** Construct a greenfield station with (8) 5000 A, 345 kV, 63 kA circuit breakers & & (1) 158.4 MVAR 345 kV Cap bank in a breaker and a half configuration. Cut into the 345 kV Hayden – Roberts No. 2 circuit with two single circuit 345 kV lines ~0.2 miles terminating into Beacon station; utilizing 2-bundle ACSR Rail 954 (45/7) conductor SE 1887 MVA. A structure will need be installed to raise the Hayden – Roberts No 1 circuit. Construct three single circuit lines ~0.1 miles, between Beacon and the customer; utilizing 2-bundle ACSR Drake 795 (26/7) conductor SE 1800 MVA. Cost: **\$40.0 M (Projected ISD : 11/21/2024)**

Need Number: AEP-2022-OH035

Process Stage: Solutions Meeting 5/9/2023, 12/5/2023

Previously Presented: Need Meeting 4/22/2022

Project Driver: Customer Service

Specific Assumption Reference:

AEP Connection Requirements for the AEP Transmission System
(AEP Assumptions Slide 12)

Problem Statement:

Customer Service:

- The customer Served out of Cosgray station (S2653) has requested additional transmission service to their existing site southeast of AEP's existing Hayden station in Hilliard, OH.
- The customer has indicated a peak demand of 218 MW at the site.
- The customer has requested an ISD of 4/1/2024

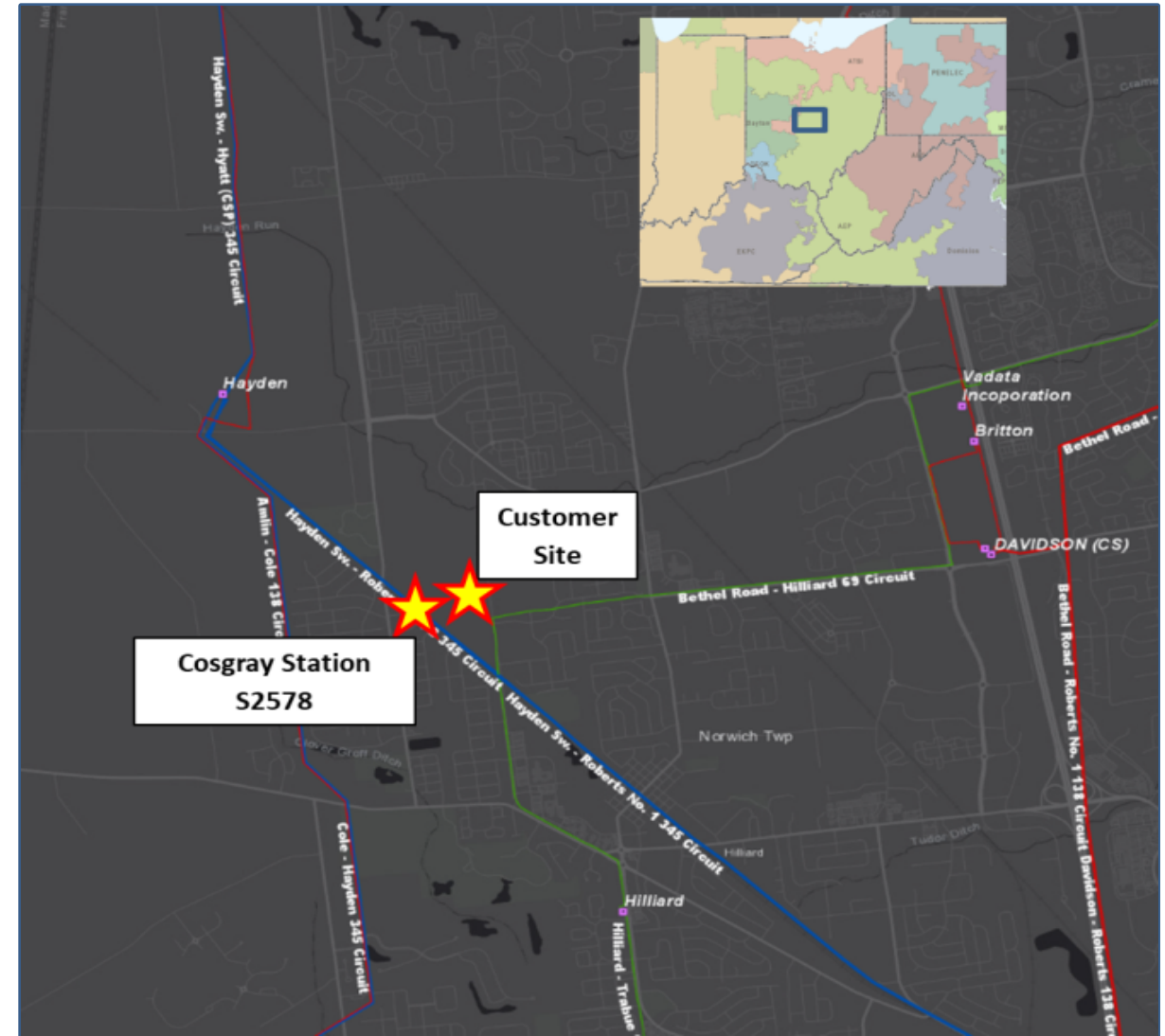

Need Number: AEP-2022-OH035

Process Stage: Solutions Meeting 5/9/2023, 12/5/2023

Proposed Solution:

The following scope of work is all direct connect facilities to physically connect demand to the grid.

- **Cosgray 345 kV:** Expand the existing Cosgray ring bus (originally proposed under s2653) station by installing (2) 5000 A, 63 kA, 345 kV circuit breakers . Construct two ~0.06 miles single circuit lines to connect the new customer deliveries to Cosgray. Cost: **\$5.1 M (Projected ISD : 6/14/2024)**

AEP Transmission Zone M-3 Process Kileville

Need Number: AEP-2023-OH041

Process Stage: Solutions Meeting 5/9/2023, 12/5/2023

Previously Presented: Needs Meeting 2/17/2023

Project Driver: Customer Service

Specific Assumption Reference:

AEP Connection Requirements for the AEP Transmission System (AEP Assumptions Slide 12)

Problem Statement:

Customer Service:

- An existing customer planned to be served out of AEP's proposed Kileville Station in Union Count, OH, has requested service for an incremental bulk load addition of 96 MW. This will bring the total & ultimate load for the customers site to 258 MW.
- Customer requested in-service date of 4/1/2024.

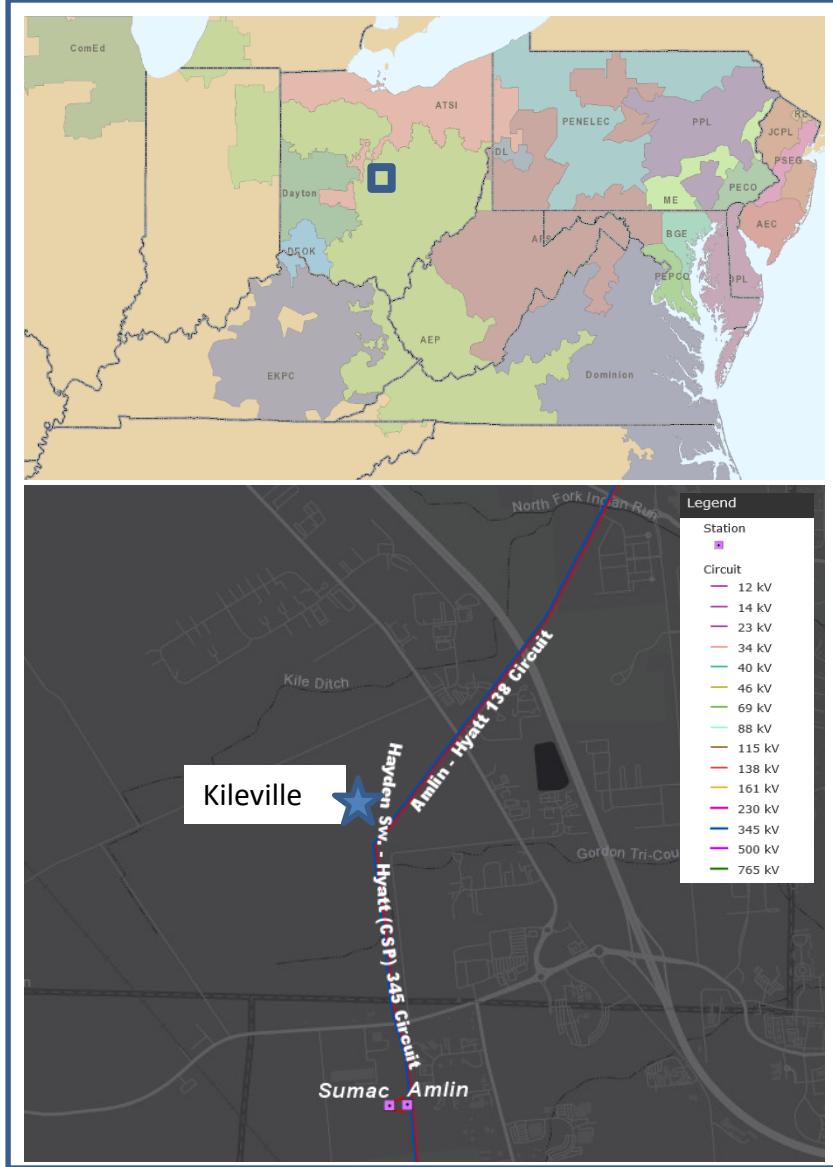

Need Number: AEP-2023-OH041

Process Stage: Solutions Meeting 5/9/2023, 12/5/2023

Proposed Solution:

The following scope of work is all direct connect facilities to physically connect demand to the grid.

- **Celtic 345/138 kV:** Originally, Kileville is the station that was envisioned (s2855) to serve 461 MW of demand with room for 345 kV expansion based on LOAs with the customer. However, land in the area of the proposed Kileville station was not available for expansion to install 345/138 kV transformation. Therefore, a new station site called Celtic is being proposed to serve as the 345 kV source for the 461 MW of load to be served in this area. Cut into the Hayden – Hyatt 345 kV circuit, reroute ~0.8 miles of the circuit and extend ~1.1 miles of new double circuit line, utilizing 2-bundled ACSR Pheasant 1272 (54/19) conductor, SE rating 2413 MVA, to the greenfield Celtic 345/138 kV station with (4) 345 kV, 63 kA, 5000 A breakers laid out as ring bus configuration on high side. Install two 675MVA-345/138 kV power transformers. Install (6) 138kV, 63 kA, 4000 A breakers & (2) 69.1 MVAR 138 kV Cap bank on low side configured as ring bus with provisions for future breaker and half configuration. The proposed Kileville – Jerome 138 kV circuit will be brought in and out of the station. Cost: **\$60 M (Projected ISD : 6/1/2025)**
- **Kileville 138 kV:** Expand Kileville station (originally proposed under s2855) with (4) additional 63 kA, 4000A circuit breakers in breaker and half bus configuration. Construct (2) 138 kV tie lines to the customers dead end structures ~0.05 miles utilizing ACSR Dove 556.5 (26/7) conductor SE 284 MVA. Customers will be directly connected at this station. Cost: **\$4.1 M (Projected ISD : 4/1/2024)**

AEP Transmission Zone M-3 Process Dublin & Hilliard, OH

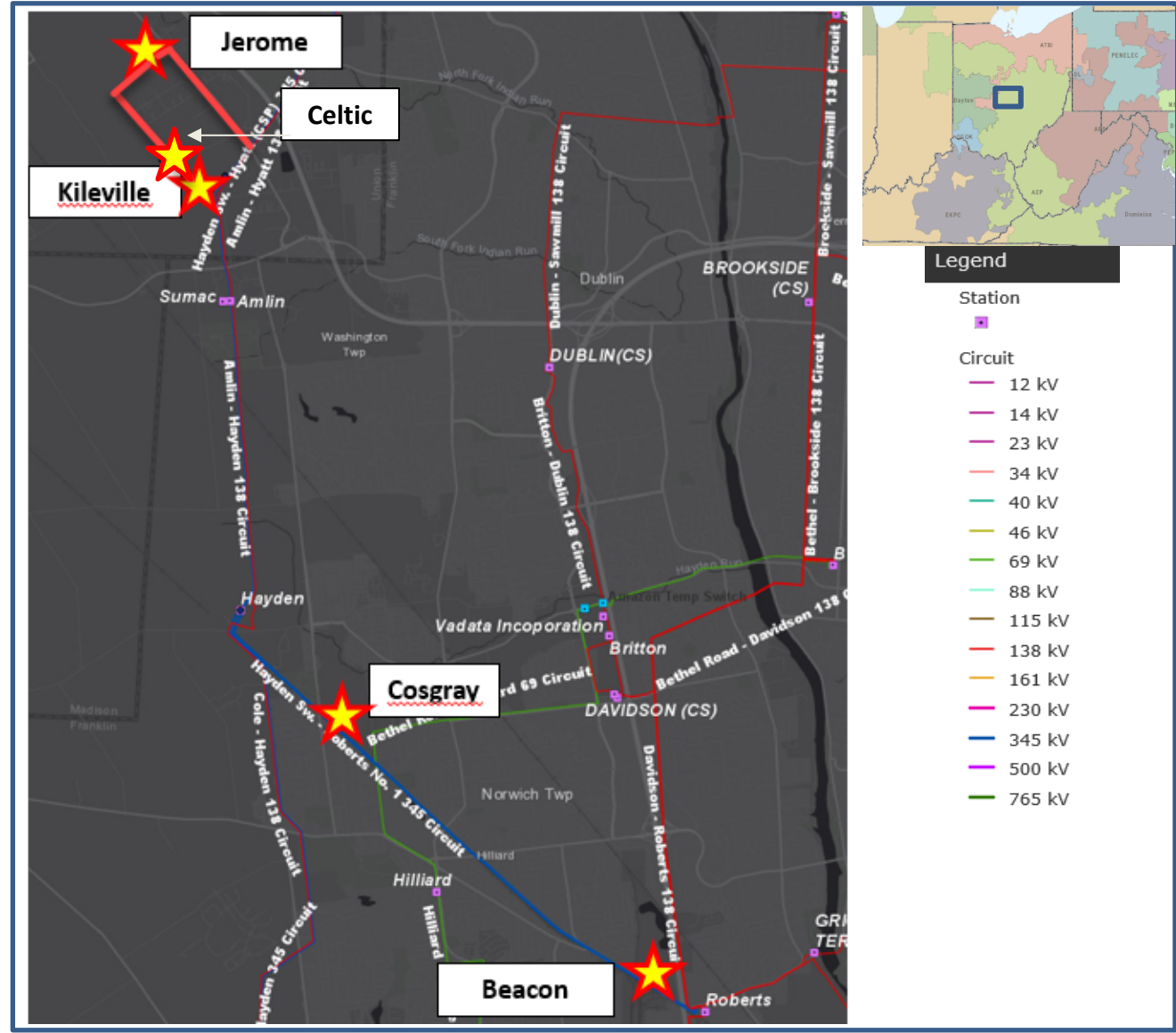

Need Number: AEP-2021-OH049, AEP-2022-OH024, AEP-2022-OH035, AEP-2023-OH041

Process Stage: Solutions Meeting 5/9/2023, 12/5/2023

Proposed Solution:

The following components are system reinforcements required to serve the load and meet applicable TPL-001, PJM, and AEP planning criteria:

- **Beatty – Wilson 138 kV line Sag Re-rate:** Due to new customer interconnections in the area the Beatty – Wilson, Beatty – Bolton, Bolton – Hall and Hall - Wilson 138 kV circuits will overload for certain N-1-1 scenarios. Structures will be replaced on the line to address distribution clearance issue in order to allow the lines to operate to their conductor’s designed maximum operating temperature. Cost: **\$1.5 M (Projected ISD : 12/1/2026)**
- **Dublin Reactor 138 kV:** Install a 4% series reactor towards Sawmill at Dublin station to address a N-1-1 scenario as a result of the new load interconnections in the area. Cost: **\$3.0 M (Projected ISD : 12/1/2026)**

System Upgrades: \$4.5M

Direct Connect Facilities: \$139.2M

Total Estimated Transmission Cost: \$143.7M

Existing:

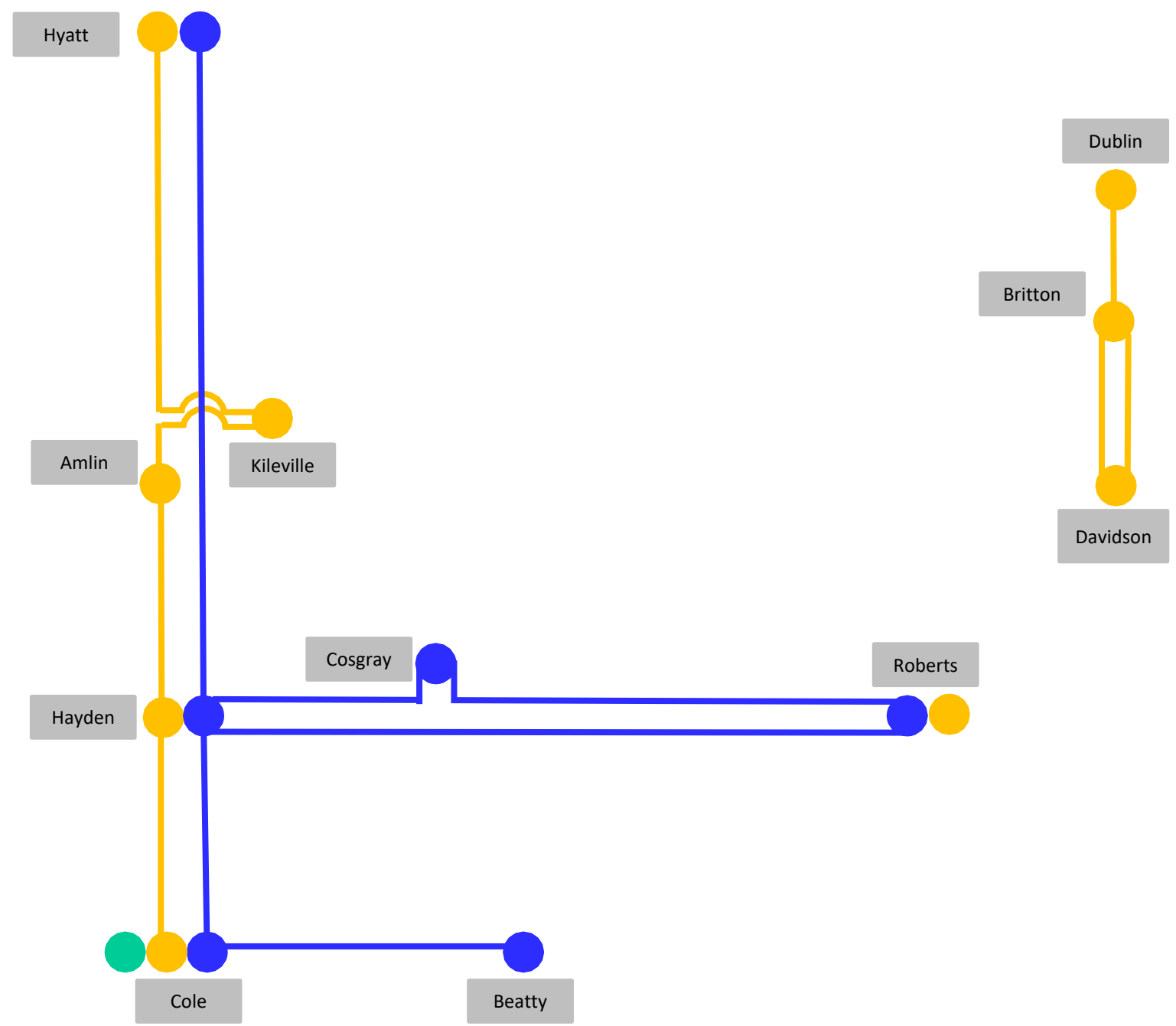

Legend	
765 kV	
345 kV	
138 kV	
69 kV	
34.5 kV	
23 kV	
New	

Existing:

Proposed:

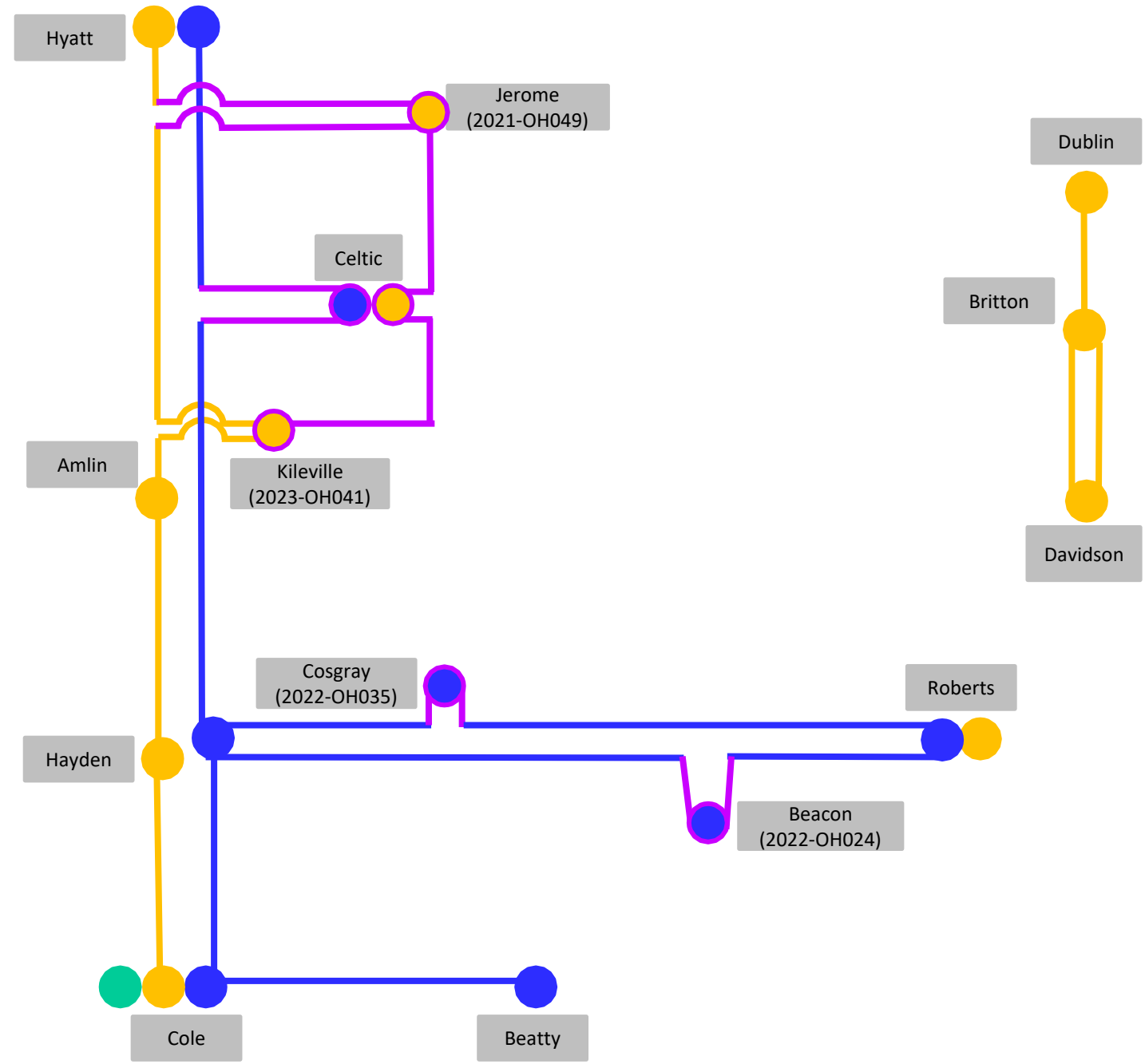

Legend	
765 kV	—
345 kV	—
138 kV	—
69 kV	—
34.5 kV	—
23 kV	—
New	—

Proposed:

Need Number: AEP-2022-OH023

Process Stage: Solutions Meeting 5/9/2023, 12/5/2023

Previously Presented: Need Meeting 2/18/2022

Project Driver: Customer Service

Specific Assumption Reference:

AEP Connection Requirements for the AEP Transmission System
(AEP Assumptions Slide 12)

Problem Statement:

Customer Service:

- A customer has requested transmission service at a site North of AEP's existing Jugg Street station in Columbus, OH.
- The customer has indicated an initial peak demand of 125 MW with an ultimate capacity of up to 290 MW at the site.
- Initial customer requested in-service date of June 1, 2024.

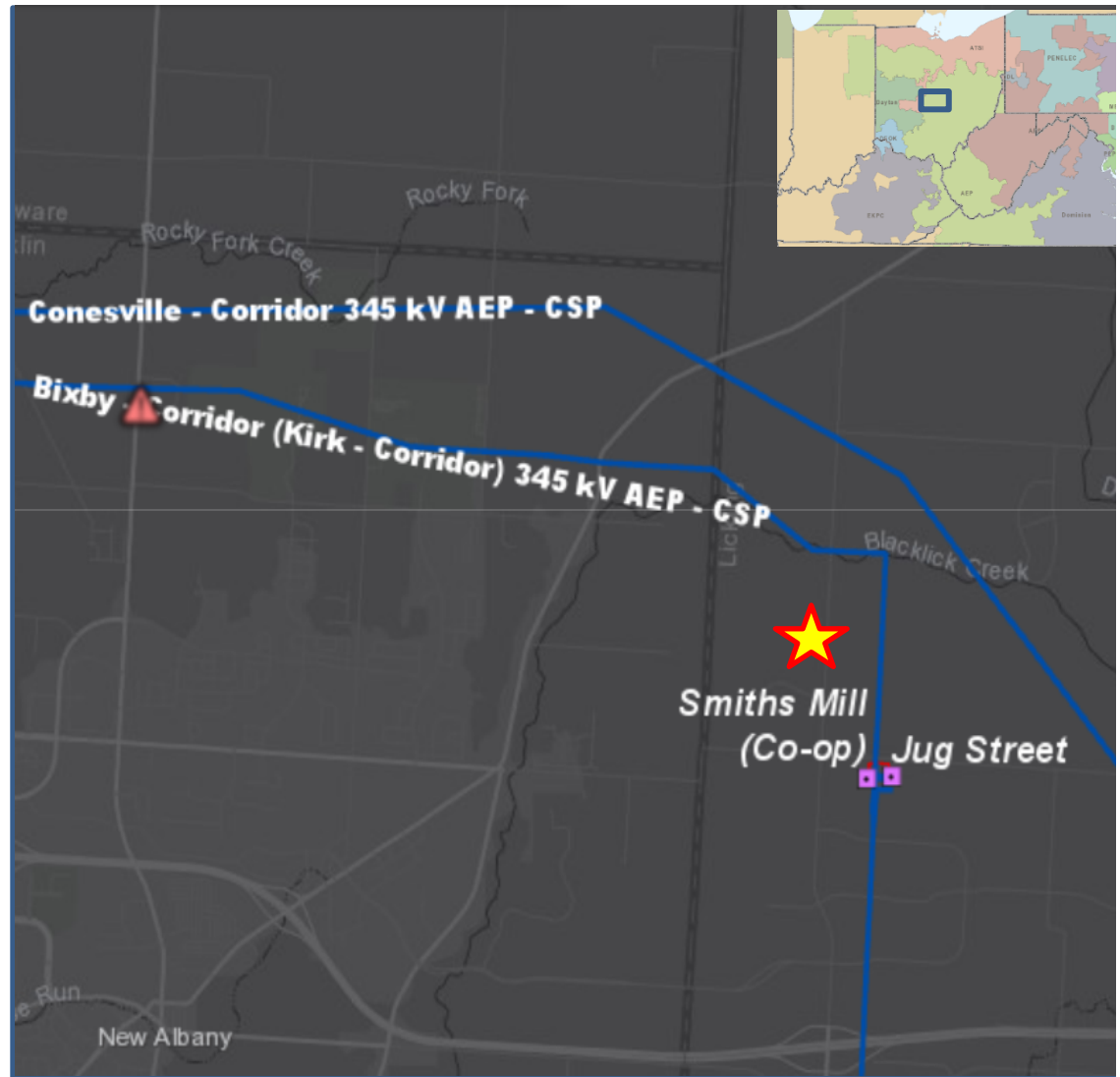

Need Number: AEP-2022-OH023

Process Stage: Solutions Meeting 5/9/2023, 12/5/2023

Proposed Solution:

The following work is all direct connect substation to physically connect demand to the grid.

- **Badger 138 kV:** Cut into the Green Chapel – Jug 138 kV circuit and extend ~ 0.1 miles of new double circuit line, utilizing 2-bundled ACSR Falcon 1590 (54/19) conductor, SE rating 1118 MVA , to the greenfield Badger station with (10) 80 kA, 4000 A breakers & (1) 69.1 MVAR 138 kV Cap bank, laid out as breaker and a half for future expansion to 6 strings. Construct 4 - 138 kV tie lines to the customers dead end structures ~.05 miles utilizing ACSR Dove 556.5 (26/7) conductor SE 284 MVA. Cost: **\$18.43 M (Projected ISD : 11/24/2024)**

Need Number: AEP-2022-OH034

Process Stage: Solutions Meeting 5/9/2023, 12/5/2023

Previously Presented: Need Meeting 4/22/2022

Project Driver: Customer Service

Specific Assumption Reference:

AEP Connection Requirements for the AEP Transmission System (AEP Assumptions Slide 12)

Problem Statement:

Customer Service:

- A customer has requested transmission service at a site East of AEP's existing Anguin station in New Albany, OH.
- The customer has indicated a peak demand of 216 MW at the site.
- The customer has requested an ISD of 5/31/2023

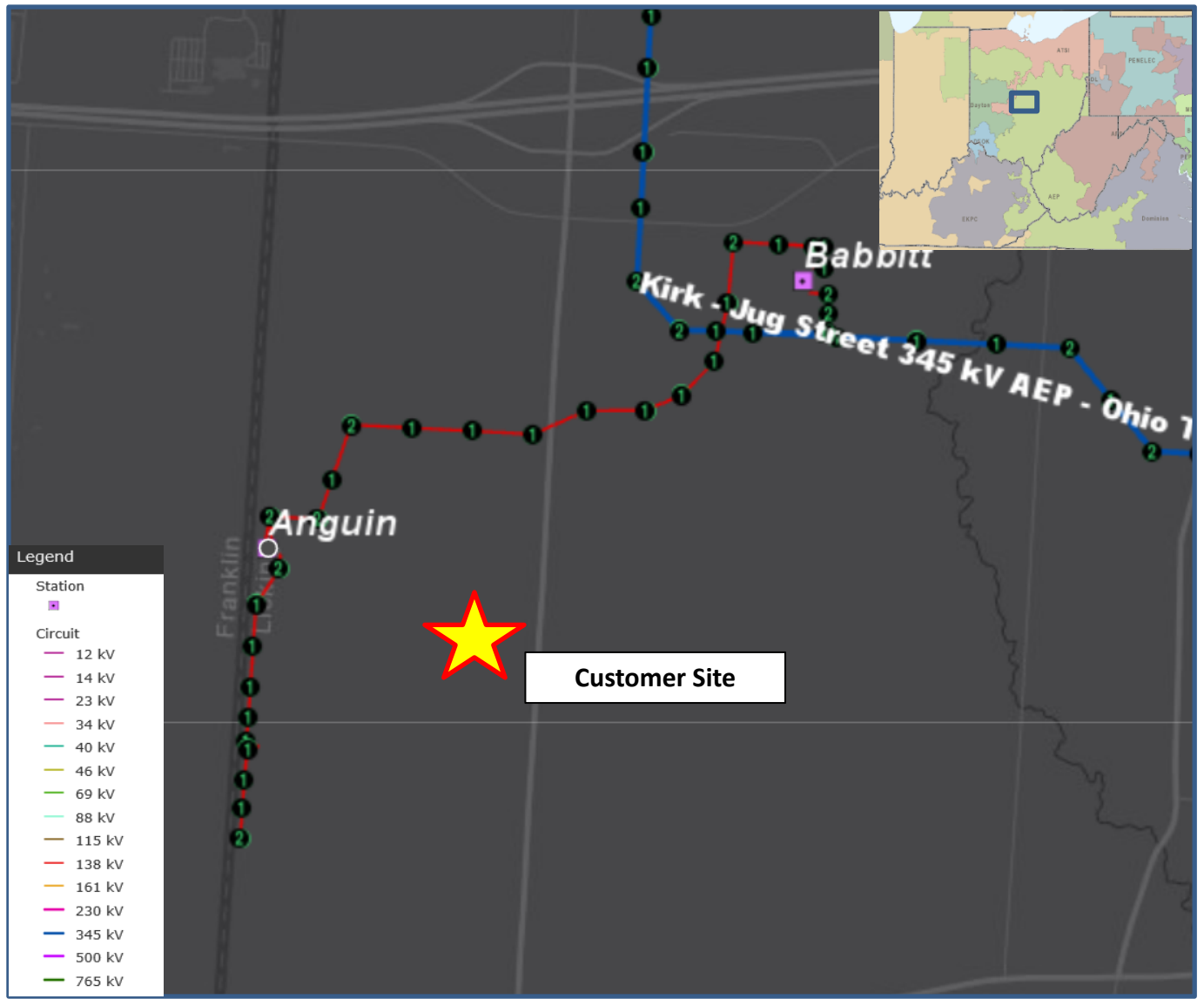

Need Number: AEP-2022-OH034

Process Stage: Solutions Meeting 5/9/2023, 12/5/2023

Proposed Solution:

The following work is all direct connect substations to physically connect demand to the grid.

- **QTS North 138 kV:** Construct ~0.3 miles of double circuit & a single circuit radial 138 kV tie lines from Anguin station to QTS Customer's site dead-end structures serving transformers #1, #2 # 3, each utilizing ACSR Dove 556.5 (26/7) conductor SE 284 MVA. Cost: **\$1.8 M (Projected ISD : 3/25/2024)**

Need Number: AEP-2022-OH036

Process Stage: Solutions Meeting 5/9/2023, 12/5/2023

Previously Presented: Need Meeting 04/22/2022

Project Driver: Customer Service

Specific Assumption Reference:

AEP Connection Requirements for the AEP Transmission System (AEP Assumptions Slide 12)

Problem Statement:

Customer Service:

- The customer served out of Innovation station (S2578) has requested additional transmission service at their existing site just south of the existing Conesville – Corridor 345 kV circuit in New Albany, OH.
- The customer has indicated a peak demand of 247 MW at the site.
- The customer has requested an ISD of 4/1/2024



Need Number: AEP-2022-OH036

Process Stage: Solutions Meeting 5/9/2023, 12/5/2023

Proposed Solution:

The following work is all direct connect substations to physically connect demand to the grid.

- **Innovation 345/138 kV:** Cut into the Corridor - Conesville 345 kV circuit and construct ~0.1 miles of double circuit line, utilizing 2-bundled ACSR Bittern 1272 conductor, SE rating 2278 MVA, to a new 345 kV ring bus at Innovation station (s2578) with (4) 5000 A, 63kA circuit breakers, (2) 345/138/34.5 kV, 675 MVA transformers, (15) 4000 A, 80, kA, 138 kV circuit breakers, (2) 69.1 MVAR, 138 kV Cap banks. Upgrade the line protection relays at Conesville & Corridor 345 kV. Construct (2) 138 kV tie lines to the customers dead end structures ~0.04 miles utilizing ACSR Dove 556.5 (26/7) conductor SE 284 MVA. Cost: **\$53.7 M**
(Projected ISD : 6/24/2026)

Need Number: AEP-2022-OH045

Process Stage: Solutions Meeting 5/9/2023, 12/5/2023

Previously Presented: Need Meeting 06/15/2022

Project Driver: Customer Service

Specific Assumption Reference:

AEP Connection Requirements for the AEP Transmission System (AEP Assumptions Slide 12)

Problem Statement:

Customer Service:

- A customer has requested distribution service at a site North of AEP's existing Jug Street station in New Albany, OH. In addition, AEP Ohio has requested an additional delivery point from this location.
- The customer has indicated their initial load demand of 50 MW with an ultimate peak demand of 200 MW at the site.
- The customer has requested an ISD of 4/30/2024

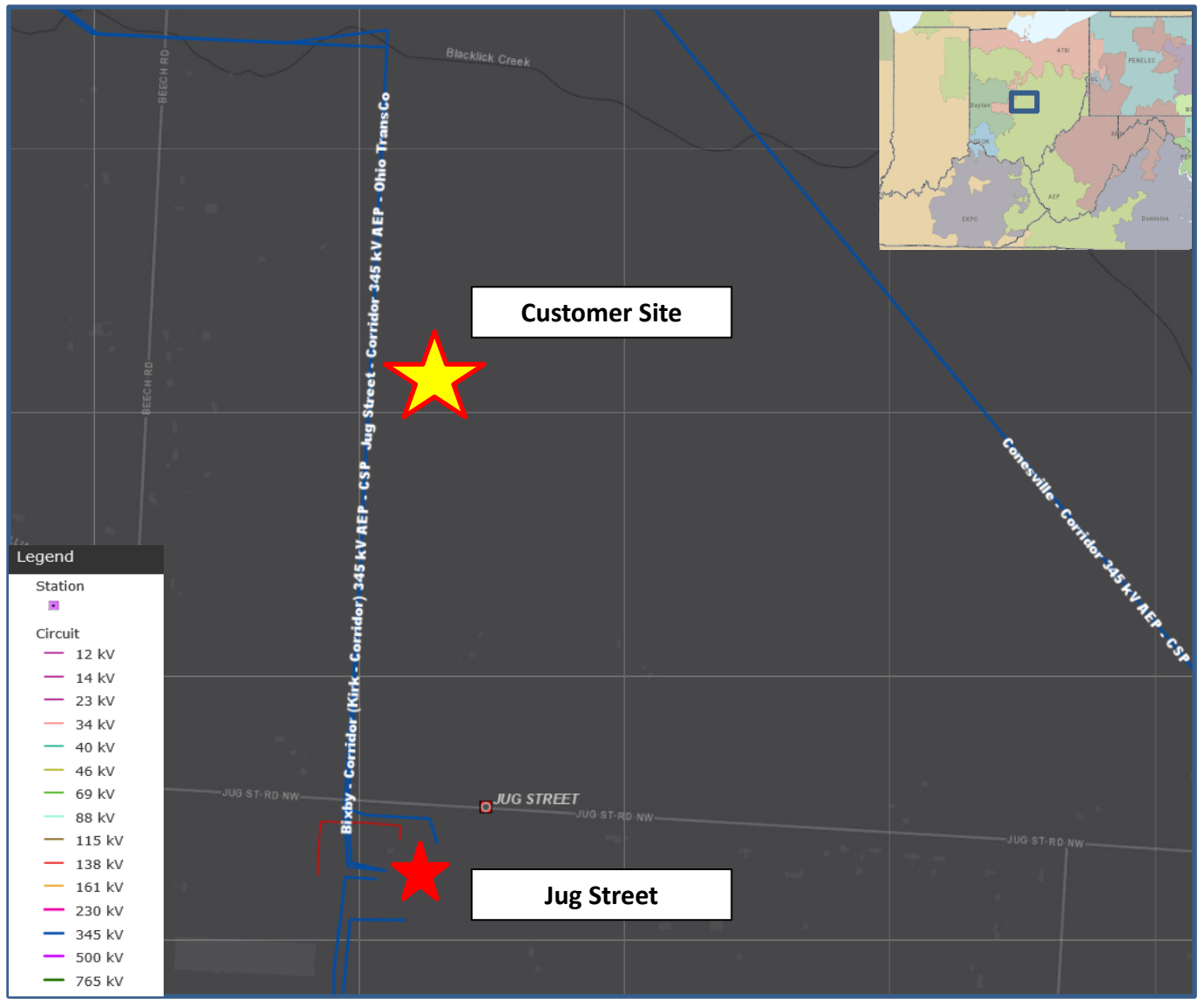

Need Number: AEP-2022-OH045

Process Stage: Solutions Meeting 5/9/2023, 12/5/2023

Proposed Solution:

The following work is all direct connect substations to physically connect demand to the grid.

- **Horizon 138 kV:** Construct a greenfield station with (8) 80 kA, 4000 A circuit breakers in breaker and half bus configuration. Construct ~ 0.05 miles of double circuit 138kV transmission line extending from the Jug St.- Green Chapel 138 kV circuit to Horizon station utilizing 2-bundled ACSR Falcon 1590 (54/19) conductor, SE rating 1118 MVA. Cost: **\$10.81 M (Projected ISD : 6/1/2025)**

Need Number: AEP-2022-OH046

Process Stage: Solutions Meeting 5/9/2023, 12/5/2023

Previously Presented: Need Meeting 6/15/2022

Project Driver: Customer Service

Specific Assumption Reference:

AEP Connection Requirements for the AEP Transmission System (AEP Assumptions Slide 12)

Problem Statement:

Customer Service:

- A customer has requested transmission service at a site East of AEP's existing Jug Street station in New Albany, OH.
- The customer has indicated their initial demand of 50 MW with an ultimate peak demand up to 270 MW in the future.
- The customer has requested an ISD of 6/28/2024



Need Number: AEP-2022-OH046

Process Stage: Solutions Meeting 5/9/2023, 12/5/2023

Proposed Solution:

The following work is all direct connect substations to physically connect demand to the grid.

- **Jorden 138 kV:** Cut into the Innovation – Kirk 138 kV circuit with two single circuit 138 kV lines ~0.35 miles terminating into Jorden station, utilizing 2-bundled ACSS Curlew 1033.5 (54/7) conductor, SE rating 1123 MVA, to Construct a greenfield 138 kV 4-CB ring bus station, configurable to 4-strings breaker and half station in future, with (4) 4000 A, 80 kA circuit breakers. Construct two single circuit 138kV lines ~0.1 miles, between Jorden and the customer. Cost: **\$12.5 M (Projected ISD : 7/10/2026)**

Need Number: AEP-2022-OH075

Process Stage: Solutions Meeting 5/9/2023, 12/5/2023

Previously Presented: Needs Meeting 12/6/2022

Project Driver: Customer Service

Specific Assumption Reference:

AEP Connection Requirements for the AEP Transmission System (AEP Assumptions Slide 12)

Problem Statement:

Customer Service:

- A customer has requested transmission service at a site Southeast of AEP’s existing Anguin station in New Albany, OH.
- The customer has indicated a peak demand of 125 MW at the site.
- The customer has requested an ISD of 8/1/2024

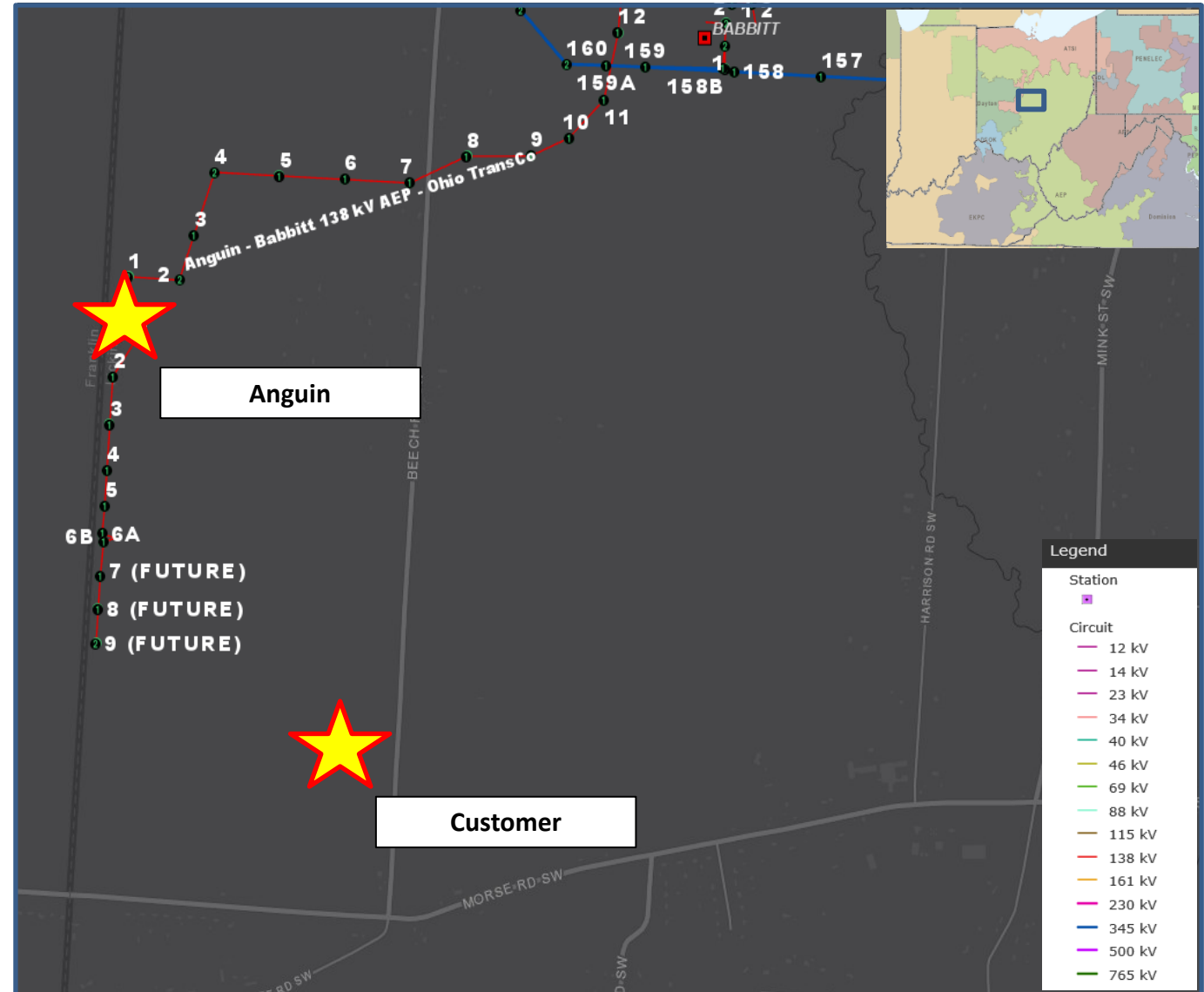

Need Number: AEP-2022-OH075

Process Stage: Solutions Meeting 5/9/2023, 12/5/2023

Proposed Solution:

The following work is all direct connect substations to physically connect demand to the grid.

- **QTS South 138 kV:** Cut into one of the circuits of Anguin – Brie 138 kV line and extend ~0.1 miles of two single circuit lines, utilizing 2-bundled ACSS Curlew 1033.5 (54/7) conductor, SE rating 1123 MVA, to the greenfield Macy station with (4) 80 kA, 4000 A breakers laid out as 4-CB ring bus. Construct (2) 138 kV tie lines to the customers dead end structures ~0.04 miles utilizing ACSR Dove 556.5 (26/7) conductor SE 284 MVA. Cost: **\$9.54 M (Projected ISD : 7/31/2024)**
- **Brie – Innovation 138 kV Tie:** Construct a greenfield ~1.75 mile of double circuit line, utilizing 2-bundled ACSS Curlew 1033.5 (54/7) conductor, connecting Brie and Innovation stations as well as re-establish the Babbitt - Kirk 138 kV circuit. At Brie 138 kV station will install four 138 kV circuit breakers in two partial strings breaker and half configuration along with a 69.1 MVAR capacitor. Perform remote end work at Innovation, Babbitt, and Kirk 138 kV stations. This project addresses a consequential (for a N-1-1 contingency) load drop event of more than 300 MW for the loads served out of AEP's Anguin and Brie stations while also addressing an overload on the Babbitt – Innovation 138 kV circuit in relation to new customer interconnections in the area. Cost: **\$10.8 M (Projected ISD : 7/31/2025)**

Need Number: AEP-2022-OH077

Process Stage: Solutions Meeting 5/9/2023, 12/5/2023

Previously Presented: Needs Meeting 12/6/2022

Project Driver: Customer Service

Specific Assumption Reference:

AEP Connection Requirements for the AEP Transmission System (AEP Assumptions Slide 12)

Problem Statement:

Customer Service:

- A customer has requested transmission service at a site north of AEP's existing Jug Street station in New Albany, OH.
- The customer has indicated an initial peak demand of 226 MW with an ultimate capacity of up to 968 MW at the site.
- The customer has requested an ISD of 5/1/2026

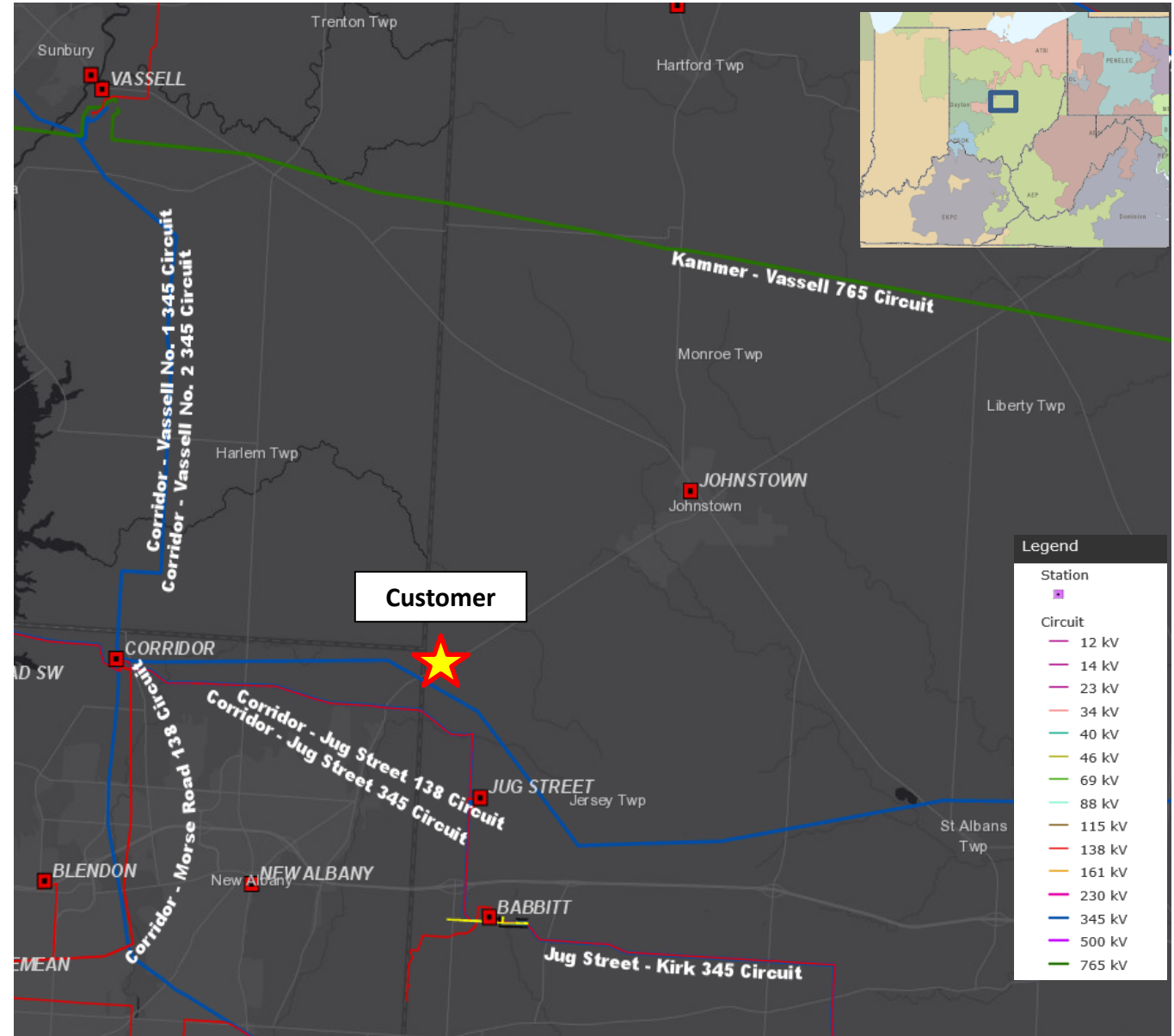

Need Number: AEP-2022-OH077

Process Stage: Solutions Meeting 5/9/2023, 12/5/2023

Proposed Solution (continued):

The following work is all direct connect facilities to physically connect demand to the grid.

- **Curleys 345 kV:** Cut into the rerouted Corridor – Innovation 345 kV circuit, utilizing 2-bundled ACSR Falcon 1590 (54/19) conductor, SE rating 2278 MVA, to a new 345 kV Curleys station with (14) 5000 A, 63kA circuit breakers & (2 ±) 158.4 MVAR 345 kV Cap bank, laid out as breaker and a half for future expansion to 3 strings with future configurations to build up to total (10) breaker and half strings. Construct four single circuit lines ~0.1 miles, between Curleys station and the customer; utilizing 2-bundle ACSR Drake 795 (26/7) conductor SE 1800 MVA. The rerouted line, built as double circuit, will establish two 345 kV ties between Bermuda and Curleys stations. Cost: ~~\$55.2 M~~ **\$57.2 M (Projected ISD : 12/1/2027)**

Reason For Update: As part of further engineering reviews it was determined that the previously proposed capacitor bank at Bermuda would be more efficiently accommodated at Curleys station. The scope update adds the 2nd capacitor at Curleys and removes it from the scope at Bermuda.

Need Number: AEP-2023-OH016

Process Stage: Solutions Meeting 5/9/2023, 12/5/2023

Previously Presented: Need Meeting 2/17/2023

Supplemental Project Driver: Customer Service

Specific Assumption Reference: AEP Guidelines for Transmission Owner Identified Needs (AEP Assumptions Slide 8)

Problem Statement:

AEP Ohio is requesting a new 138kV delivery point near the Corridor - Jug 138kV circuit by June 2025 to support continued growth in and around the New Albany, Ohio area. Initial load is anticipated to be approximately 24.0 MVA with a future projected load of approximately 100 MVA.

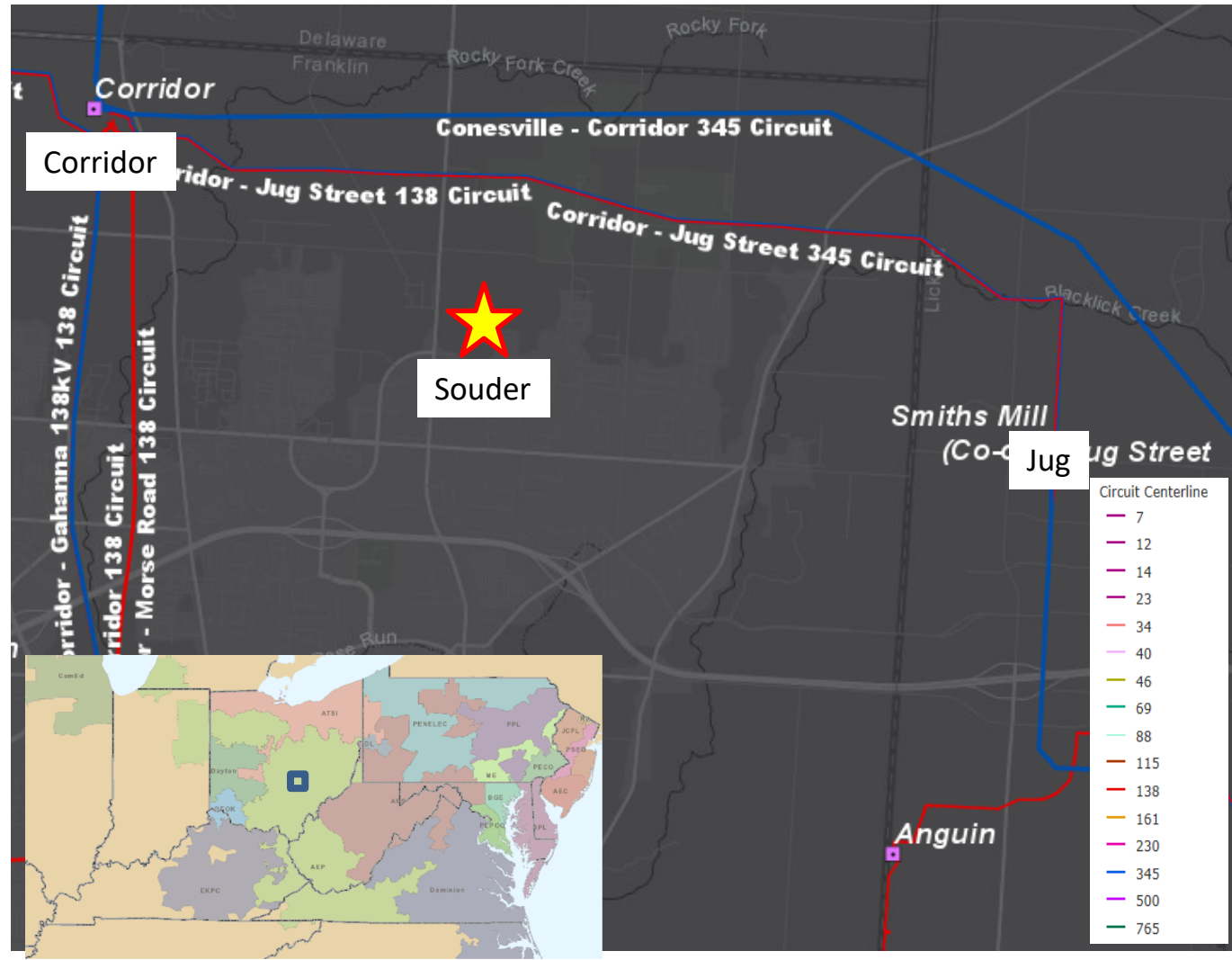

Need Number: AEP-2023-OH016

Process Stage: Solutions Meeting 5/9/2023, 12/5/2023

Proposed Solution:

The following work is all direct connect substations to physically connect demand to the grid.

- **Souder 138 kV:** Cut into the Corridor – Green Chapel 138 kV circuit and extend ~1.0 mile of new double circuit line, utilizing 2-bundled ACSR Falcon 1590 (54/19) conductor, SE rating 1118 MVA , to the greenfield Souder station with (5) 80 kA, 4000 A breakers laid out as 5-CB ring bus for future expansion to 6-CB ring. Cost: **\$14.31 M (Projected ISD : 10/22/2025)**

Need Number: AEP-2023-OH019

Process Stage: Solutions Meeting 5/9/2023, 12/5/2023

Previously Presented: Needs Meeting 2/7/2023

Project Driver: Customer Service

Specific Assumption Reference:

AEP Connection Requirements for the AEP Transmission System (AEP Assumptions Slide 12)

Problem Statement:

Customer Service:

- A customer has requested transmission service at a site north of AEP's existing Jug Street station in New Albany, OH.
- The customer has indicated that their initial and ultimate peak demand will be 337 MW at the site.
- The customer has requested an ISD of 12/15/2025

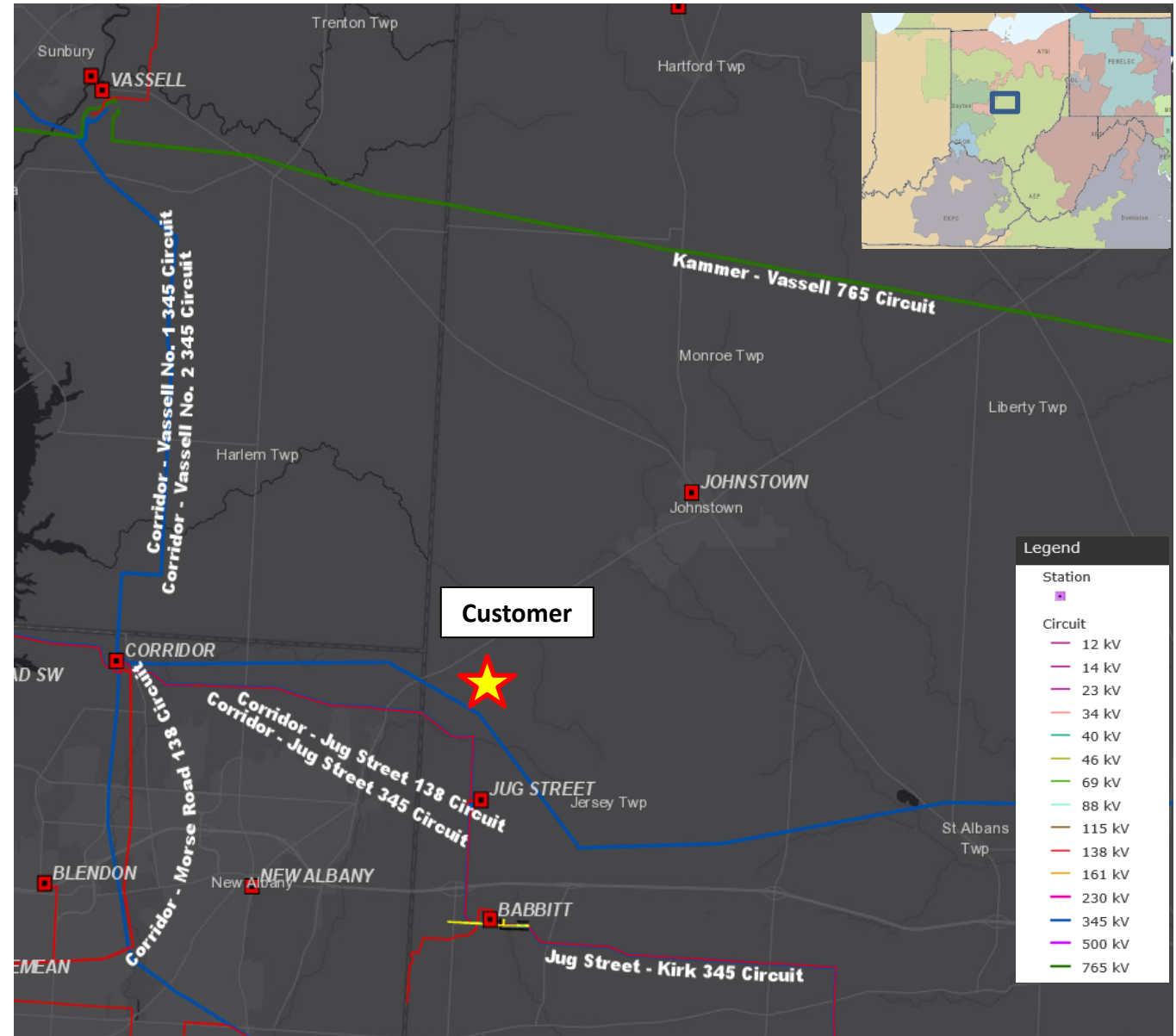

Need Number: AEP-2023-OH019

Process Stage: Solutions Meeting 5/9/2023, 12/5/2023

Proposed Solution (continued):

The following work is all direct connect facilities to physically connect demand to the grid.

- **Bermuda 345 kV:** Reroute the Corridor – Innovation 345 kV circuit across the customer’s site utilizing 2-bundled ACSR Falcon 1590 (54/19) conductor, built with double circuit structures, SE rating 2278 MVA, to a new 345 kV Bermuda station with (11) 5000 A, 63kA circuit breakers & ~~(1) 158.4 MVAR 345 kV Cap bank~~, laid out as breaker and a half configuration. Construct four single circuit lines ~0.1 miles, between Bermuda station and the customer; utilizing 2-bundle ACSR Drake 795 (26/7) conductor SE 1800 MVA. Cost: ~~\$60.3 M~~ **\$58.3 M (Projected ISD : 9/12/2025)**

Reason For Update: As part of further engineering reviews it was determined that the previously proposed capacitor bank at Bermuda would be more efficiently accommodated at Curleys station. The scope update adds the 2nd capacitor at Curleys and removes it from the scope at Bermuda.

Need Number: AEP-2023-OH032

Process Stage: Solutions Meeting 5/9/2023, 12/5/2023

Previously Presented: Needs Meeting 2/17/2023

Project Driver: Customer Service

Specific Assumption Reference:

AEP Connection Requirements for the AEP Transmission System (AEP Assumptions Slide 12)

Problem Statement:

Customer Service:

- A customer has requested transmission service at a site North of AEP's existing Jug Street station in Columbus, OH.
- The customer has indicated an initial peak demand of 50 MW with an ultimate capacity of up to 300 MW at the site.
- Initial customer requested in-service date of January 1, 2026

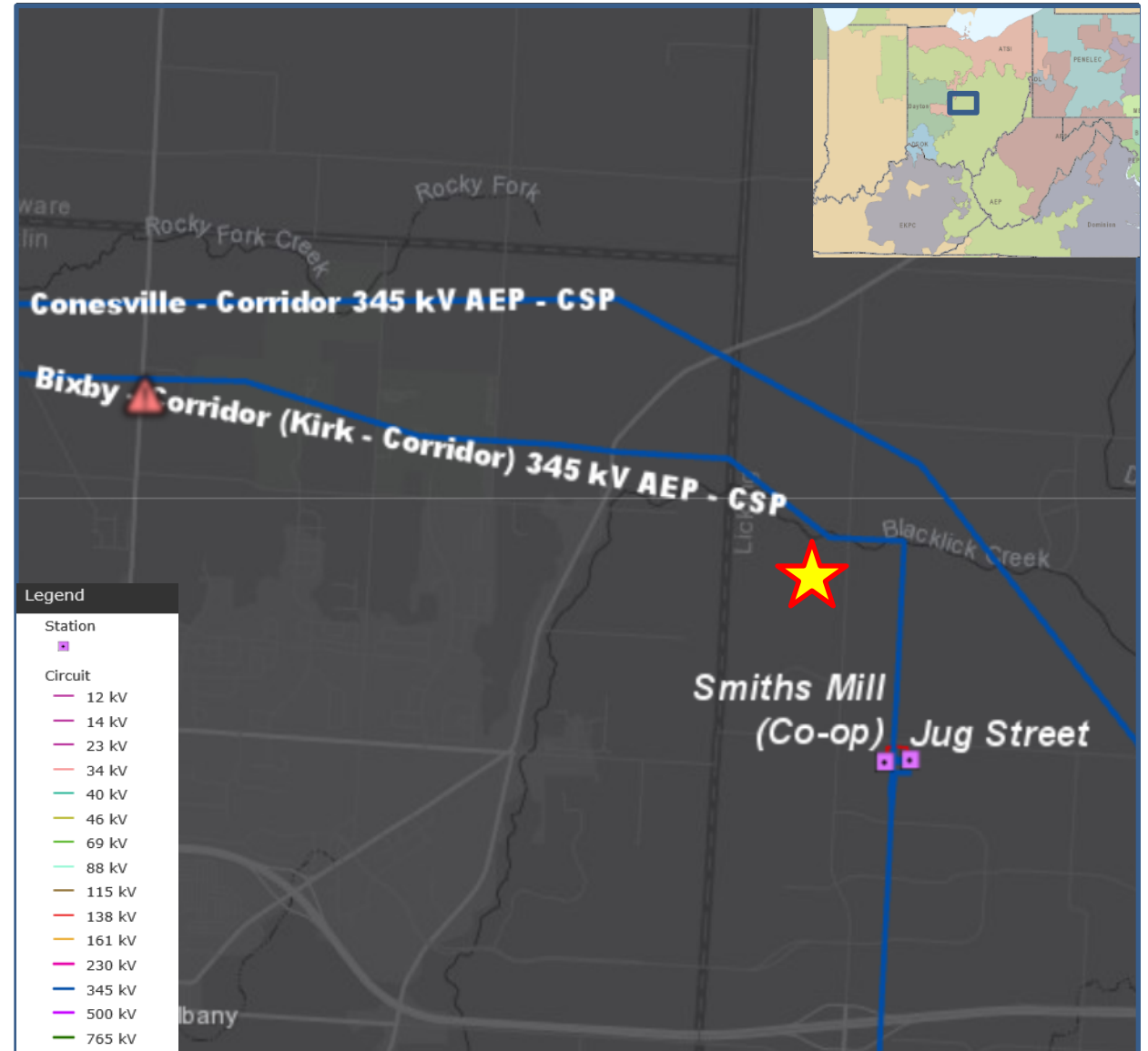

Need Number: AEP-2023-OH032

Process Stage: Solutions Meeting 5/9/2023, 12/5/2023

Proposed Solution (continued):

The following work is all direct connect facilities to physically connect demand to the grid.

- **Fiesta 138 kV:** Cut into the Corridor – Green Chapel 138 kV circuit and extend ~ 0.75 miles of new double circuit line, utilizing 2-bundled ACSR Falcon 1590 (54/19) conductor, SE rating 1118 MVA , to the greenfield Fiesta station with (10) 80 kA, 4000 A breakers laid out as breaker and a half for future expansion to 6 strings. Construct 4 - 138 kV tie lines to the customers dead end structures ~0.05 miles utilizing ACSR Drake 795 (26/7) conductor SE 360 MVA. Cost: **\$22.3 M (Projected ISD : 1/2/2026)**

AEP Transmission Zone M-3 Process Rockhopper

Need Number: AEP-2023-OH040

Process Stage: Solutions Meeting 5/9/2023, 12/5/2023

Previously Presented: Need Meeting 2/17/2023

Project Driver: Customer Service

Specific Assumption Reference:

AEP Connection Requirements for the AEP Transmission System (AEP Assumptions Slide 12)

Problem Statement:

Customer Service:

- An existing customer served out of AEP's Anguin Station in New Albany, OH, has requested an additional service for a new bulk load addition of 100 MW. This will bring the total load for the customers site to 350 MW with an ultimate capacity of up to 720 MW.
- Customer requested in-service date of 5/31/2023.

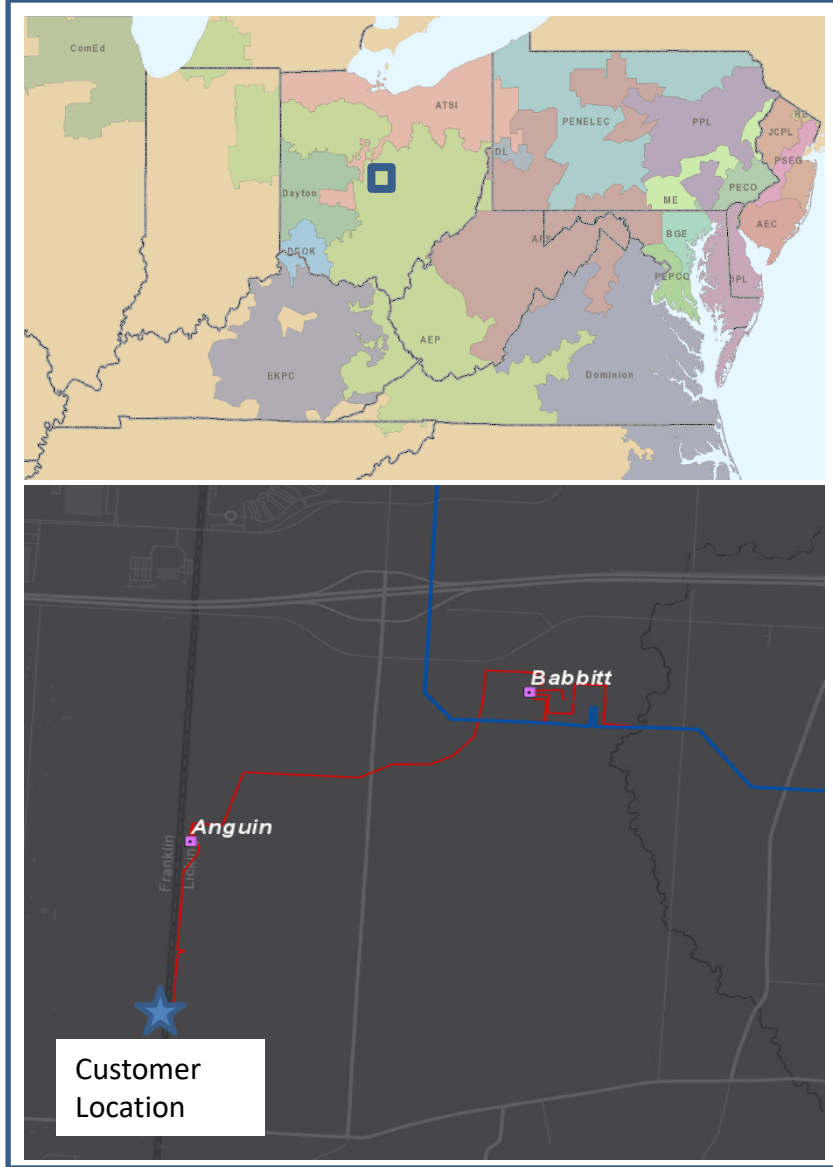

Need Number: AEP-2023-OH040

Process Stage: Solutions Meeting 5/9/2023, 12/5/2023

Proposed Solution (continued):

The following work is all direct connect facilities to physically connect demand to the grid.

- **Anguin – Rockhopper 138 kV:** Reconfigure existing Anguin station and install (10) 138 kV, 4000A, 80 kA circuit breakers to feed customer stations at Penguin and QTS North. Build out strings G & H and construct a new greenfield ~0.6 miles double circuit line to customer’s Rockhopper station. Install (2) 69.1 MVAR cap banks at Anguin station Cost: **\$13.2 M (ISD : 2/20/2024)**

Need Number: AEP-2023-OH044

Process Stage: Solutions Meeting 5/9/2023, 12/5/2023

Previously Presented: Needs Meeting 3/17/2023

Project Driver: Customer Service

Specific Assumption Reference:

AEP Connection Requirements for the AEP Transmission System (AEP Assumptions Slide 12)

Problem Statement:

- A customer has requested service to a new delivery point in New Albany Ohio, just east of Jug Street Station.
- The projected demand for the site is 54 MW with an ultimate capacity of up to 150 MW.
- Customer requested in-service date of 12/19/2025.

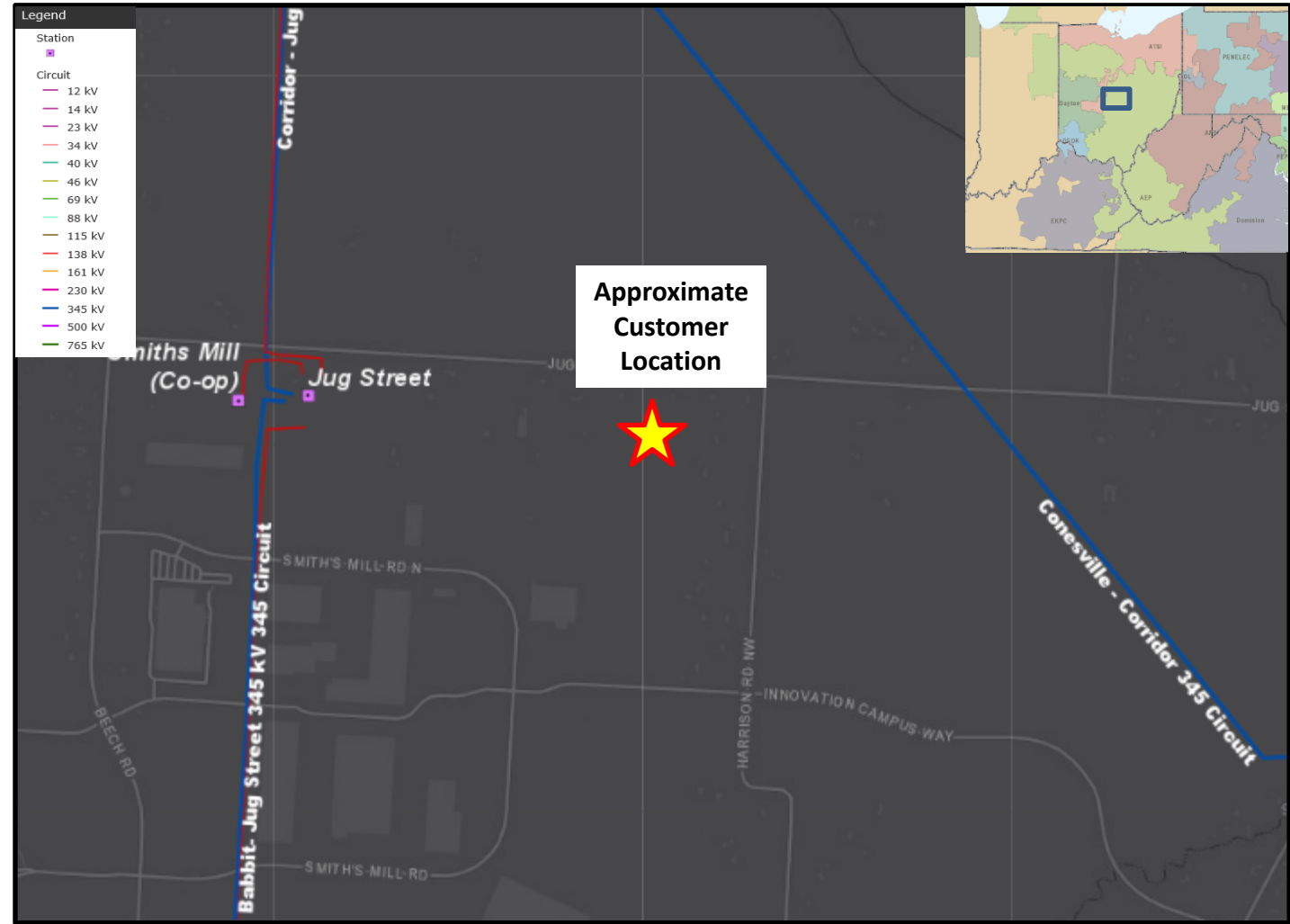

Need Number: AEP-2023-OH044

Process Stage: Solutions Meeting 5/9/2023, 12/5/2023

Proposed Solution (continued):

The following work is all direct connect facilities to physically connect demand to the grid.

- **Tasjan 138 kV:** Cut into the Innovation – Green Chapel 138 kV circuit #1 and extend ~ 0.75 miles of new double circuit line, utilizing 2-bundled ACSS Curlew 1033.5 (54/7) conductor, SE rating 1123 MVA, to the greenfield Tasjan station with (4) 80 kA, 4000 A breakers laid out 4-CB ring bus. Construct (2) 138 kV tie lines to the customers dead end structures ~0.05 miles utilizing ACSR Drake 795 (26/7) conductor SE 360 MVA. Cost: **\$18.95 M (Projected ISD : 11/19/2025)**

Need Number: AEP-2023-OH052

Process Stage: Solutions Meeting 5/9/2023, 12/5/2023

Previously Presented: Needs Meeting 4/21/2023

Project Driver: Customer Service

Specific Assumption Reference:

AEP Connection Requirements for the AEP Transmission System (AEP Assumptions Slide 12)

Problem Statement:

- An existing customer served out of AEP’s Anguin Station in New Albany, OH, has requested an additional service for a new bulk load addition of 100 MW. This will bring the total load for the customers site to 450 MW with an ultimate capacity of up to 720 MW.
- Customer requested in-service date of 3/31/2024.

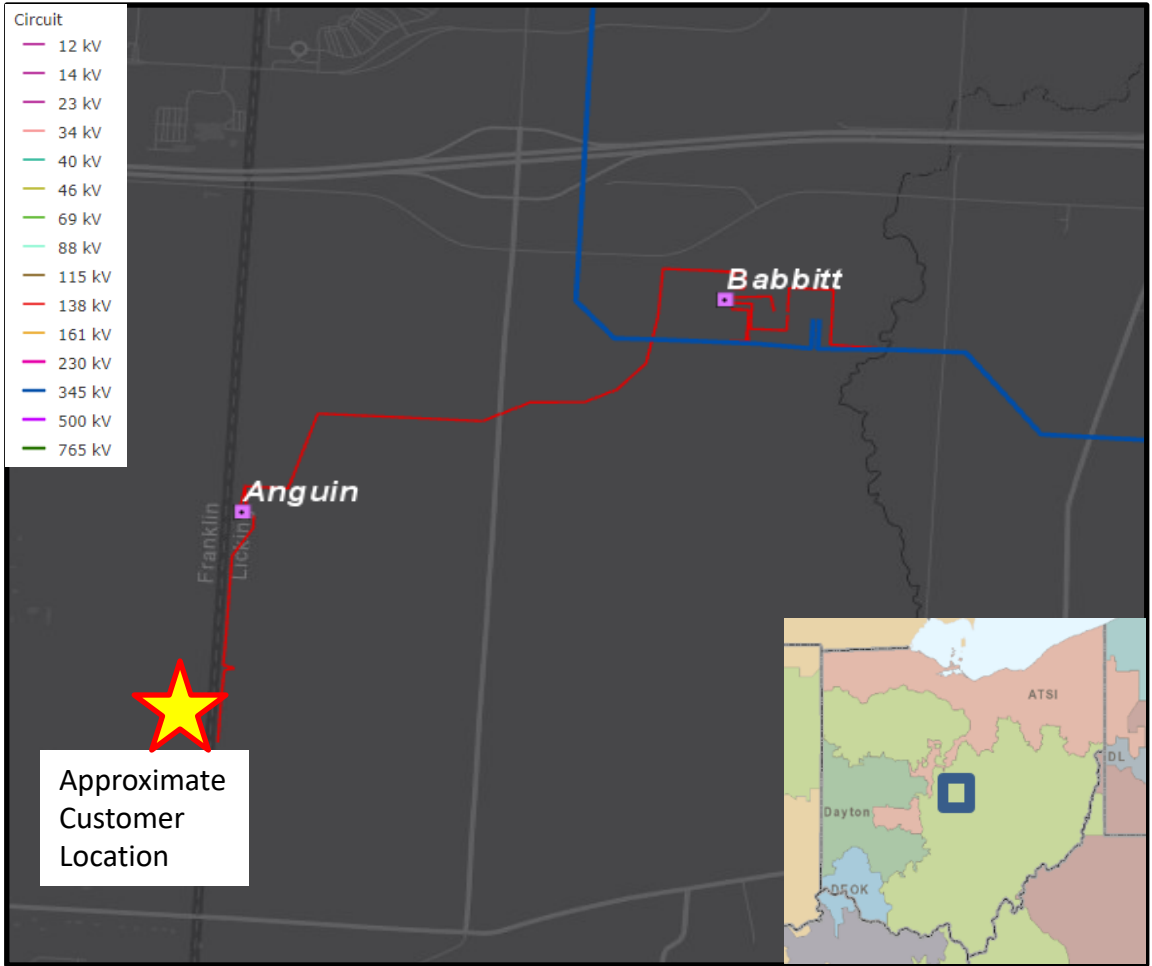

Need Number: AEP-2023-OH052

Process Stage: Solutions Meeting 5/9/2023, 12/5/2023

Proposed Solution (continued):

The following work is all direct connect facilities to physically connect demand to the grid.

- **Anguin – Chinstrap 138 kV:** Extend the 138 kV double circuit line to Rockhopper by ~0.22 miles to the new Chinstrap (customer) station. Cost: **\$1.01 M**
(Projected ISD : 4/4/2024)

Need Number: AEP-2023-OH063

Process Stage: Solutions Meeting 5/9/2023, 12/5/2023

Previously Presented: Needs Meeting 4/21/2023

Project Driver: Customer Service

Specific Assumption Reference:

AEP Connection Requirements for the AEP Transmission System (AEP Assumptions Slide 12)

Problem Statement:

- An existing customer served out of AEP’s Anguin Station in New Albany, OH, has requested an additional service for a new bulk load addition of 100 MW. This will bring the total load for the customers site to 550 MW with an ultimate capacity of up to 720 MW.
- Customer requested in-service date of 7/31/2024.

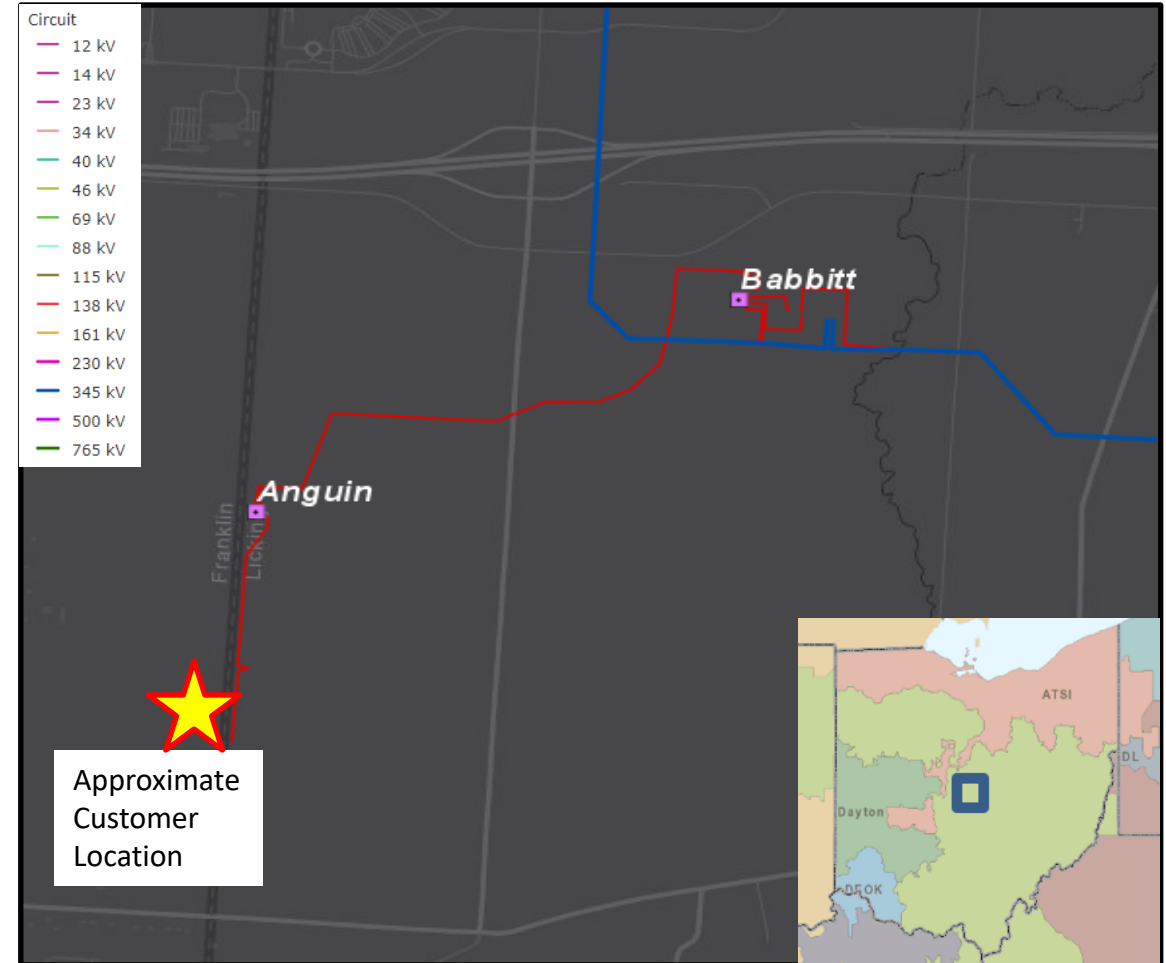

Need Number: AEP-2023-OH063

Process Stage: Solutions Meeting 5/9/2023, 12/5/2023

Proposed Solution (continued):

The following work is all direct connect facilities to physically connect demand to the grid.

- **Anguin – NBY-6A 138 kV:** Install (3) 138 kV, 4000A, 80 kA circuit breakers and construct a new greenfield ~0.9 miles double circuit line to customer's new NBY-6A station. Cost: **\$6.92 M (Projected ISD : 1/31/2025)**

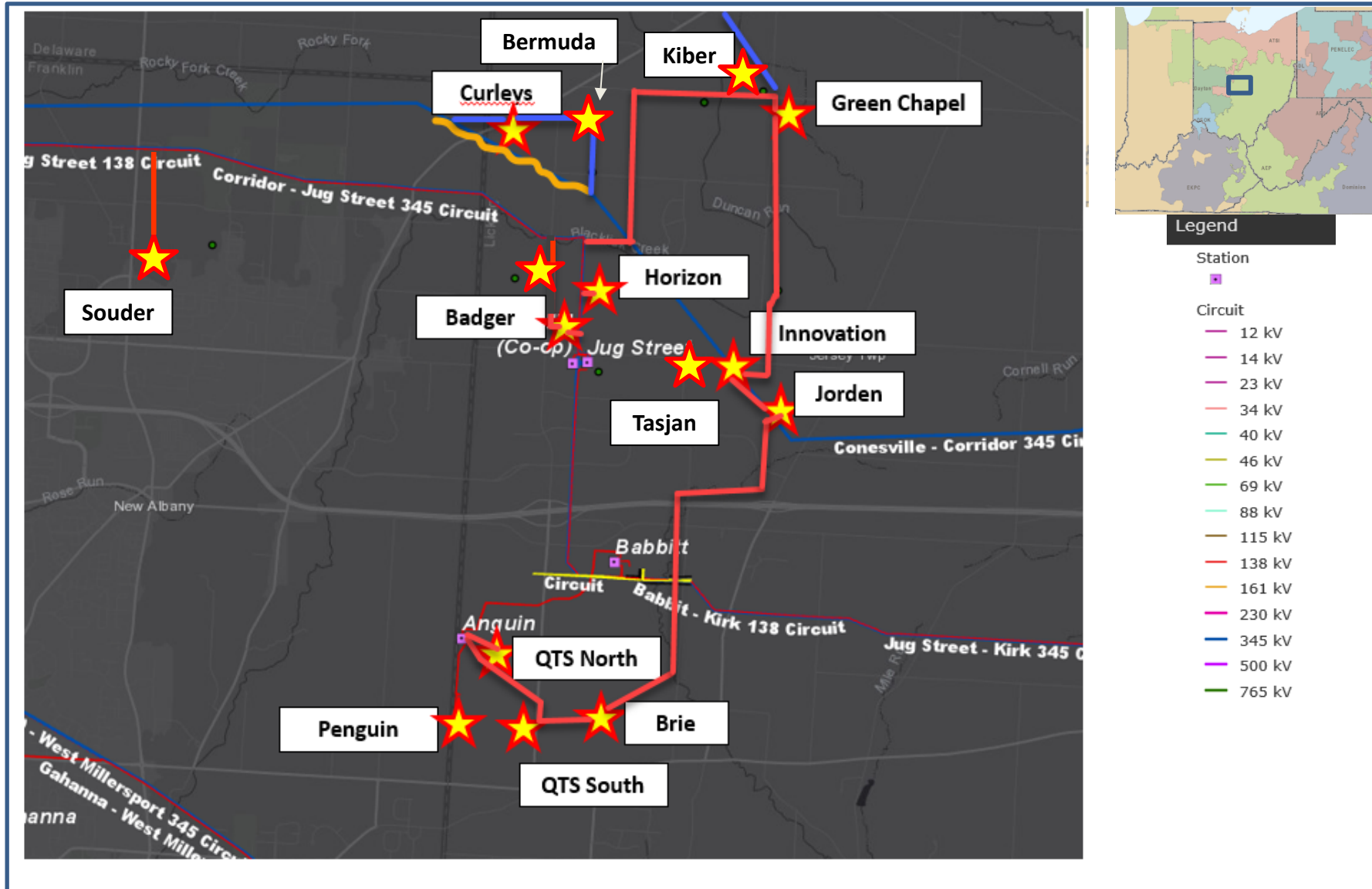

AEP Transmission Zone M-3 Process Central/NW OH, Indiana.

Need Number: AEP-2022-OH023, AEP-2022-OH034, AEP-2022-OH036, AEP-2022-OH045, AEP-2022-OH046, AEP-2022-OH075, AEP-2022-OH077, AEP-2023-OH016, AEP-2023-OH019, AEP-2023-OH032, AEP-2023-OH040, AEP-2023-OH044, AEP-2023-OH052, AEP-2023-OH063

Process Stage: Solutions Meeting 5/9/2023, 12/5/2023

Proposed Solution (continued):

The following components are system reinforcements required to serve the load and meet applicable TPL-001, PJM, and AEP planning criteria:

- **Corridor – Vassell 345 kV #1 & #2 Circuits Sag Re-rate:** Replace two structures to mitigate sag issues on the line in order to allow the line to operate to its conductor’s designed maximum operating temperature. Cost: **\$1.88 M (Projected ISD : 10/14/2025)**
- **Kiber Station 138 kV:** Cut-into Green Chapel – Corridor 138 kV circuit to a new Kiber station with (8 ~~3~~) 80 kA 138 kV circuit breakers laid out in a breaker and a half arrangement to install a ~~300~~ 2x150 MVAR STATCOM to support the significant amount of load added to the area. Cost: **\$35 M (Projected ISD : 5/2/2027)**

Reason For Update: As part of further engineering analysis it was determined that in order to be able to physically accommodate the line exits along with two feeds to the STATCOM when taking into account future needs at the station that a total of 8 138 kV breakers would need to be installed initially

- **Green Chapel Cap Banks 138 kV:** Upgrade proposed cap banks at Green Chapel station from (2) 69.1 MVAR to (2) 115.2 MVAR. Cost: **\$3.6 M (Projected ISD : 10/2/2026)**
- **Corridor 138 kV:** Replace (12) 63 kA circuit breakers & cap breakers with 80 kA circuit breakers to improve interrupting capabilities as a result of the new sources in the area. Cost: **\$12.6 M (Projected ISD : 6/1/2025)**
- **Babbitt 138 kV:** Replace (2) 63 kA bus-tie circuit breakers with 80 kA circuit breakers to improve interrupting capabilities as a result of the new sources in the area. Cost: **\$2.15 M (Projected ISD : 2/17/2026)**
- **Jug Street:** Replace CB-C which is an existing 40 kA breaker with a 4000A 80kA 138 kV breaker to address interrupting capability concerns related to the introduction of the new 345 kV source at Innovation. Cost: **\$0.8 M (Projected ISD : 4/8/2025)**

AEP Transmission Zone M-3 Process Central/NW OH, Indiana.

Need Number: AEP-2022-OH023, AEP-2022-OH034, AEP-2022-OH036, AEP-2022-OH045, AEP-2022-OH046, AEP-2022-OH075, AEP-2022-OH077, AEP-2023-OH016, AEP-2023-OH019, AEP-2023-OH032, AEP-2023-OH040, AEP-2023-OH044, AEP-2023-OH052, AEP-2023-OH063

Process Stage: Solutions Meeting 5/9/2023, 12/5/2023

Proposed Solution (continued):

The following components are system reinforcements required to serve the load and meet applicable TPL-001, PJM, and AEP planning criteria:

- **Anchor Hocking – Lancaster 69 kV line Rebuild:** Rebuild ~1.16 miles of 69 kV line utilizing ACSR Dove 556.5 (26/7) conductor, SE 142 MVA. As a result of the new customer interconnections in the area, this line will overload under certain N-1-1 scenarios. Cost: **\$2.5 M (Projected ISD : 6/29/2026)**
- **Newark Center 138 kV:** Install high and low side sectionalizing on the 138/69 kV transformer to address overloading of 69 kV lines in the area related to the new customer interconnections under certain N-1-1 scenarios. Cost: **\$2.5 M (Projected ISD : 5/3/2027)**
- **Fremont – West Fremont Sag re-rate 138 kV:** Sag re-rate the 138 kV circuit & upgrade 1200 A switches at Fremont to address a Generation deliverability violation related to the new customer interconnections in the area. Cost: **\$2.0 M (Projected ISD : 12/1/2026)**
- **Fremont – Fremont Center Sag re-rate 138 kV:** Sag re-rate the 138 kV circuit to address a Generation deliverability violation related to the new customer interconnections in the area. Cost: **\$1.5 M (Projected ISD : 12/1/2026)**
- **Dumont 765 kV:** Replace 3000 A circuit breaker at Dumont to address a generation deliverability violation on the Dumont – Sorenson 765 kV branch related to the new customer interconnections in the area. Cost: **\$4.0 M (Projected ISD : 12/1/2026)**

System Upgrades: 68.53M

Direct Connection Cost: 309.77M

Total Estimated Transmission Cost: \$378.3M

AEP Transmission Zone M-3 Process Central/NW OH, Indiana.

Need Number: AEP-2022-OH023, AEP-2022-OH034, AEP-2022-OH036, AEP-2022-OH045, AEP-2022-OH046, AEP-2022-OH075, AEP-2022-OH077, AEP-2023-OH016, AEP-2023-OH019, AEP-2023-OH032, AEP-2023-OH040, AEP-2023-OH044, AEP-2023-OH052, AEP-2023-OH063

Process Stage: Solutions Meeting 5/9/2023, 12/5/2023

Proposed Solution (continued):

The following components are system reinforcements that were initially identified by AEP and later confirmed by PJM through their DNH analysis:

- **Vassell – Green Chapel 345 kV line:** Install approximately 12.5-mile long 345 kV transmission between Vassell and Green Chapel stations to mitigate overloading on multiple transmission facilities including other 345 kV transmission lines and 345-138 kV transformers. Cost: **\$75.0 M (Projected ISD : 4/1/2026)**
- **Vassell – Curleys 345 kV line:** Install approximately 12.5-mile long 345 kV transmission between Vassell and Curleys stations to mitigate overloading on multiple transmission facilities including other 345 kV transmission lines and 345-138 kV transformers. Cost: **\$75.0 M (Projected ISD : 12/1/2026)**
- **Vassell 765 & 345 kV stations:** Add 3-345 kV breakers to connect new lines to Curleys and Green Chapel. Cost: **\$10 M (Projected ISD : 4/1/2026)**
- **Green Chapel 345/138 kV station:** Install two 675 MVA, 345/138 kV transformers to connect the new Vassell – Green Chapel 345 kV line to 138 kV system and to mitigate overloading on the other 345/138 kV transformers in the system. Cost: **\$39.2 M (Projected ISD : 4/1/2026)**

System Upgrades: \$199.2 M

Existing:

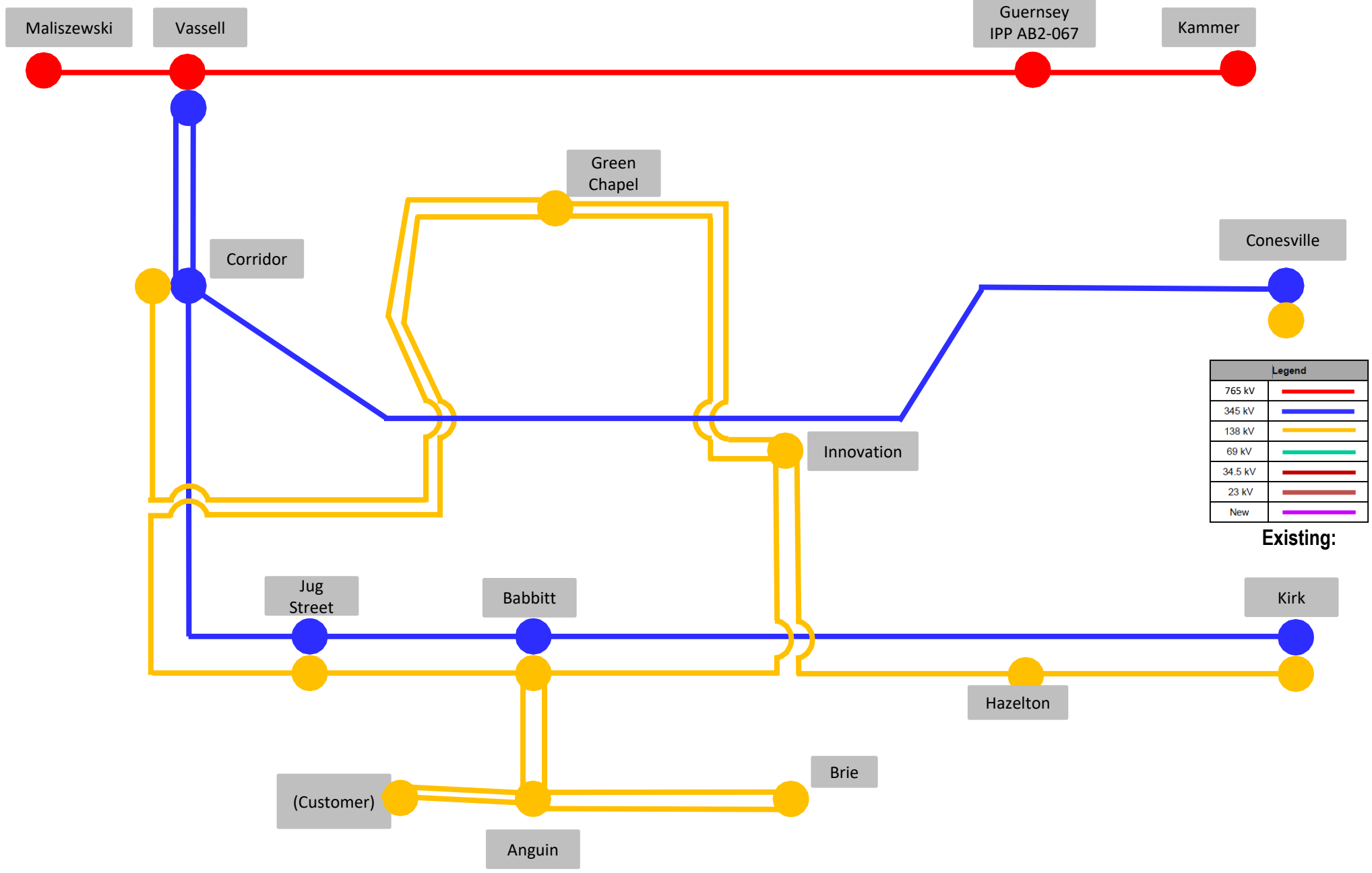

Legend	
765 kV	
345 kV	
138 kV	
69 kV	
34.5 kV	
23 kV	
New	

Existing:

Proposed:

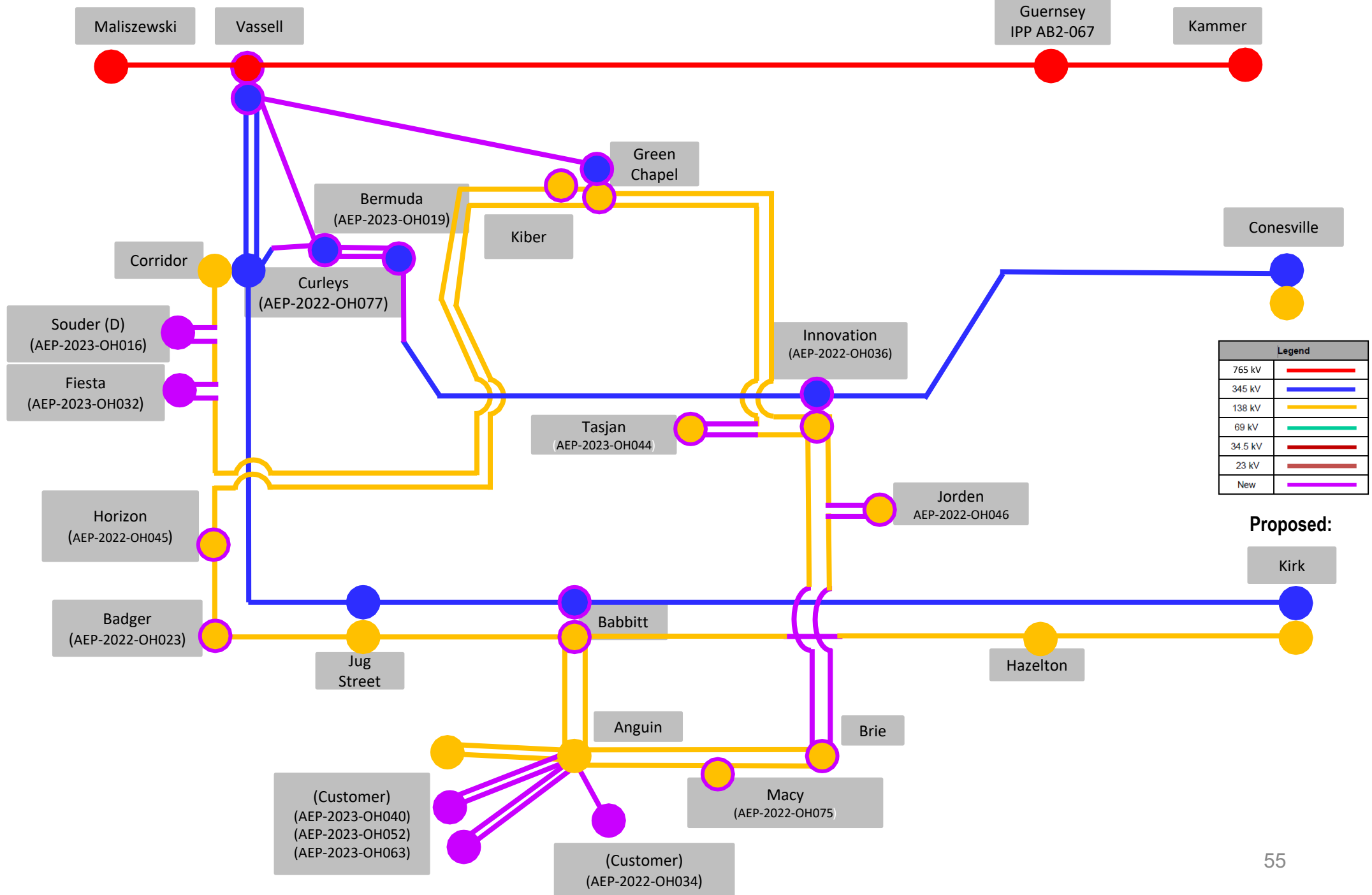

Process Stage: Solutions Meeting 5/9/2023, 12/5/2023

Alternatives Considered:

These alternates are only for consideration for system upgrades. The direct connect facilities, considering the location of the customer requests, do not have any alternates that would allow AEP to meet the requested timeframe.

- Beacon station: Serving the customer load via a new 138kV breaker and a half station and tying into the Bethel- Roberts 138kV double circuit line was considered vs. providing service at 345 kV. The site is located in a densely populated area just west of Columbus. The 138 kV facilities are located across a major interstate from the site whereas the existing 345 kV crosses the site today. Two separate double circuit lines would have been required to cross the interstate to serve the initial customer load. Tying into the 138 kV would have also required significantly more upgrades to support the upper end of the customer's projected load at the site in the future. Because of these reasons the decision was made to move forward with serving the site at 345 kV.
- Brie – Innovation 138 kV: Rather than reconfiguring the line already proposed extension to Innovation to tie into the new line extension from Brie just cutting into the Kirk – Innovation or Babbitt – Innovation circuit was considered. Analysis showed that these alternative configurations would have led to the 138 kV towards Babbitt overloading.
- Celtic 345/138 kV: Consideration was given to cutting into the nearby First Energy owned London – Tangy line into Jerome station to offset the need for the 345/138 kV source at Celtic but the analysis showed that the line could not support the load and the proposed Celtic 345/138 kV station would be required regardless.
- A new 765 kV source into the area was not deemed to be a feasible alternative to the installation of a second 765/345 kV transformer at Vassell station as it would be cost prohibitive. Vassell station is already set up to accommodate a second transformer. Any new 765 kV source will have to be sourced from Kammer station, which is 115 miles away from the New Albany area.

Total Proposed Alternate Costs: \$2.0B

AEP Transmission Zone M-3 Process New Albany, Dublin & Hilliard, OH

Need Number: AEP-2022-OH023, AEP-2022-OH034, AEP-2022-OH036, AEP-2022-OH045, AEP-2022-OH046, AEP-2022-OH075, AEP-2022-OH077, AEP-2023-OH016, AEP-2023-OH019, AEP-2023-OH032, AEP-2023-OH040, AEP-2023-OH044, AEP-2023-OH052, AEP-2023-OH063, AEP-2021-OH049, AEP-2022-OH024, AEP-2022-OH035, AEP-2023-OH041, AEP-2022-OH071

Process Stage: Solutions Meeting 5/9/2023, 12/5/2023

Total Direct Connection Costs: 497.87M

Total System Upgrade Costs: ~~\$81.63M~~ **\$280.83 M**

Total Estimated Transmission Costs: ~~\$579.5M~~ **\$778.70 M**

Projected In-Service: 12/1/2026

Project Status: Scoping/Engineering

Model: 2027 RTEP

Questions?



Appendix

High level M-3 Meeting Schedule

Assumptions	Activity	Timing
	Posting of TO Assumptions Meeting information	20 days before Assumptions Meeting
	Stakeholder comments	10 days after Assumptions Meeting

Needs	Activity	Timing
	TOs and Stakeholders Post Needs Meeting slides	10 days before Needs Meeting
	Stakeholder comments	10 days after Needs Meeting

Solutions	Activity	Timing
	TOs and Stakeholders Post Solutions Meeting slides	10 days before Solutions Meeting
	Stakeholder comments	10 days after Solutions Meeting

Submission of Supplemental Projects & Local Plan	Activity	Timing
	Do No Harm (DNH) analysis for selected solution	Prior to posting selected solution
	Post selected solution(s)	Following completion of DNH analysis
	Stakeholder comments	10 days prior to Local Plan Submission for integration into RTEP
	Local Plan submitted to PJM for integration into RTEP	Following review and consideration of comments received after posting of selected solutions

Revision History

11/22/2023 - V1 – Original version posted to pjm.com

11/27/2023 – V2 – Slide #51, Updated the “Reason For Update”

11/28/2023 – V3 – Slide #39, Updated the “Reason For Update”

3/18/2024 – V4 – Added detailed projected IS date for each project