

PJM Sub Regional RTEP Committee – Mid-Atlantic

January 22, 2016

*Esam Khadr, Sr. Director
Electric Delivery Planning, PSE&G*

PSE&G System Characteristics

New Jersey utility characterized by densely populated load areas, limited space for expansion, particularly in northern New Jersey.

▪ **69kV Facilities**

- In service in 1970s and later. Established tie with other TOs
- Adds more flexibility in transmission planning.
- Higher capacity – equivalent to more than four (4) 26kV circuits
- Uses wood pole construction on city streets.
- More reliable
 - less vegetation impact because of higher poles
 - networked construction as opposed to radial 26kV
- With the continued conversion of 138kV to higher voltages, 69kV acts as a new transition/sub-transmission system between the 230kV/345kV and the distribution system.

▪ **26kV Facilities**

- In service since early 1900s; near end of their useful life cycle.
- Looped nature of system makes it difficult to arrange outages and transfer out loads to other switching stations in a heavily loaded station/area.
- Limited capacity for future growth.
- City streets are congested. Limited ability to construct additional 26kV circuits on city streets.
- Circuits do not have the required capacity to supply large commercial customers (e.g.. data centers)

PSE&G Supplemental Projects Philosophy

- Projects that are not the result of violations to NERC TPL standards, PJM or PSE&G reliability criteria, but address problems that impact PSE&G reliability performance and standards, subject to an exception for certain 69kV facilities.
 - Maintaining reliability to the PSE&G 138kV and sub-transmission network.
 - Addressing PSE&G's maximum allowable load drop.
 - Addressing equipment condition.
 - Improving and maintaining a reliable supply to the distribution system.
 - Modernizing the system to improve operational performance (e.g. optical fiber, telemetry upgrades).

PSE&G Supplemental Projects Philosophy

- PSE&G criteria includes both transmission and distribution system violations.
- We classified certain 69kV projects as supplemental given that the drivers for these projects are primarily distribution related, including 26kV aging infrastructure, reliability criteria violations and insufficient capacity.

PSE&G Aging Infrastructure Projects

- Identified and prioritized based on analysis of the following metrics:
 - Age of Asset
 - Asset health and condition
 - SAIDI/ CAIDI/ MAIFI
 - Industry standards/guidelines
 - Wood structures: 35-55 years
 - Conductor and connectors: 40-60 years
 - Porcelain insulators: 50 years

PSE&G Aging Infrastructure Projects

- For the projects being reviewed today, PSE&G did consider system performance with the facility removed from service.
- PSE&G considers the current rating specification of the equipment and lines, as well as future system requirements in determining the ratings and specifications of replacement facilities.

e.g.:

- 69kV line rated for 95MVA summer normal and 131.5MVA summer emergency
- 69kV transformers are rated for 300MVA summer normal and 350MVA summer emergency.
- 69kV system is networked and acts as sub-transmission, provides additional reliability, and is planned for ultimate transmission/distribution system needs.

PSE&G Future Load Growth Projects

- 69kV solution - most cost effective solution.
- Alternative considered:
 - Alternative of upgrading switching stations was not as cost effective.
- 69kV facilities are operated as part of the networked system.

138kV Project

138kV Overloaded Circuit

- Circuit is overloaded
- Damaged and exposed control cables – includes 26kV substation protection
- Five (5) overstressed 138kV breakers

Existing Control Cables



Bergen Gen Unit 1 Existing Topology

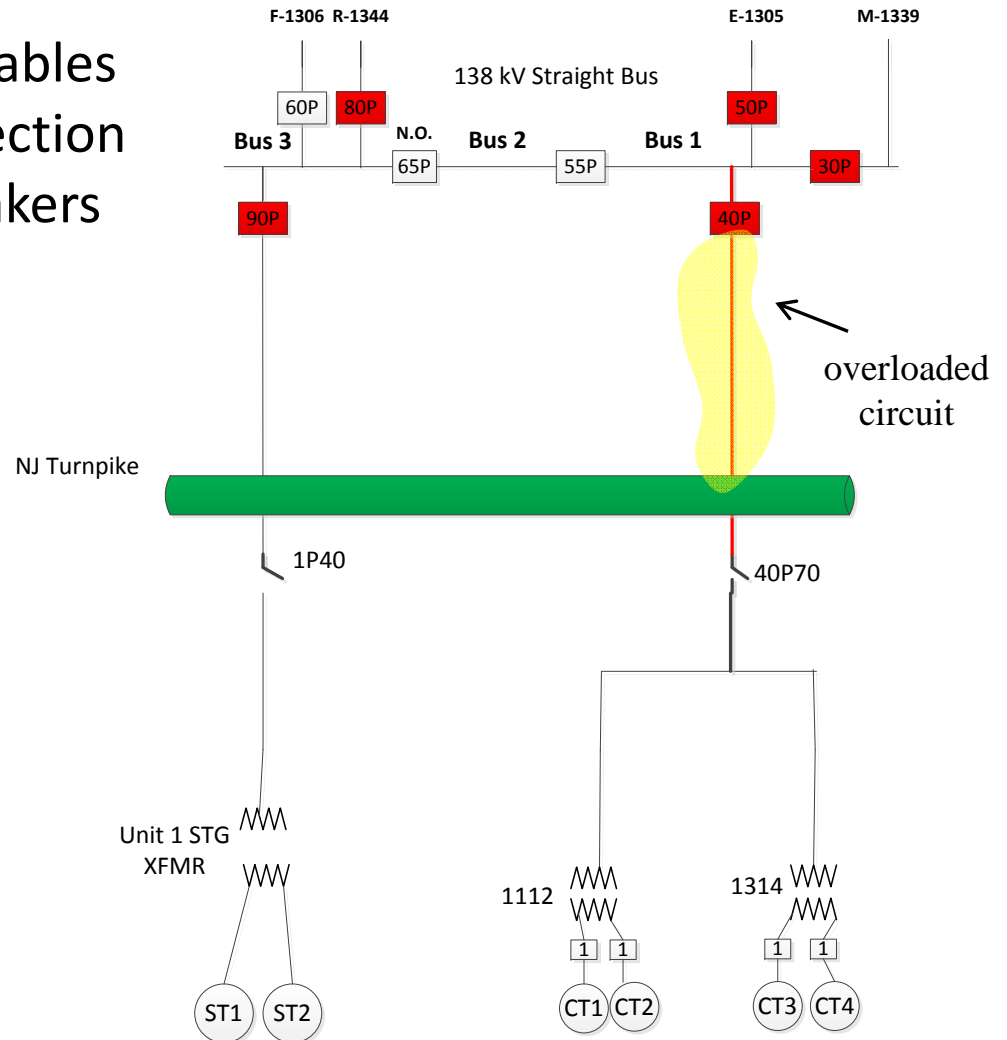

Proposed Solution

- Rebuild/Reconductor 138kV ckt (1 mi)
- Upgrade control cables using OPGW
- Relocate and upgrade breakers

Estimated Cost

\$6.5M – PSE&G

\$12.7M – Generation Owner

Schedule IS Date

Fall 2016

Project Status

Conceptual

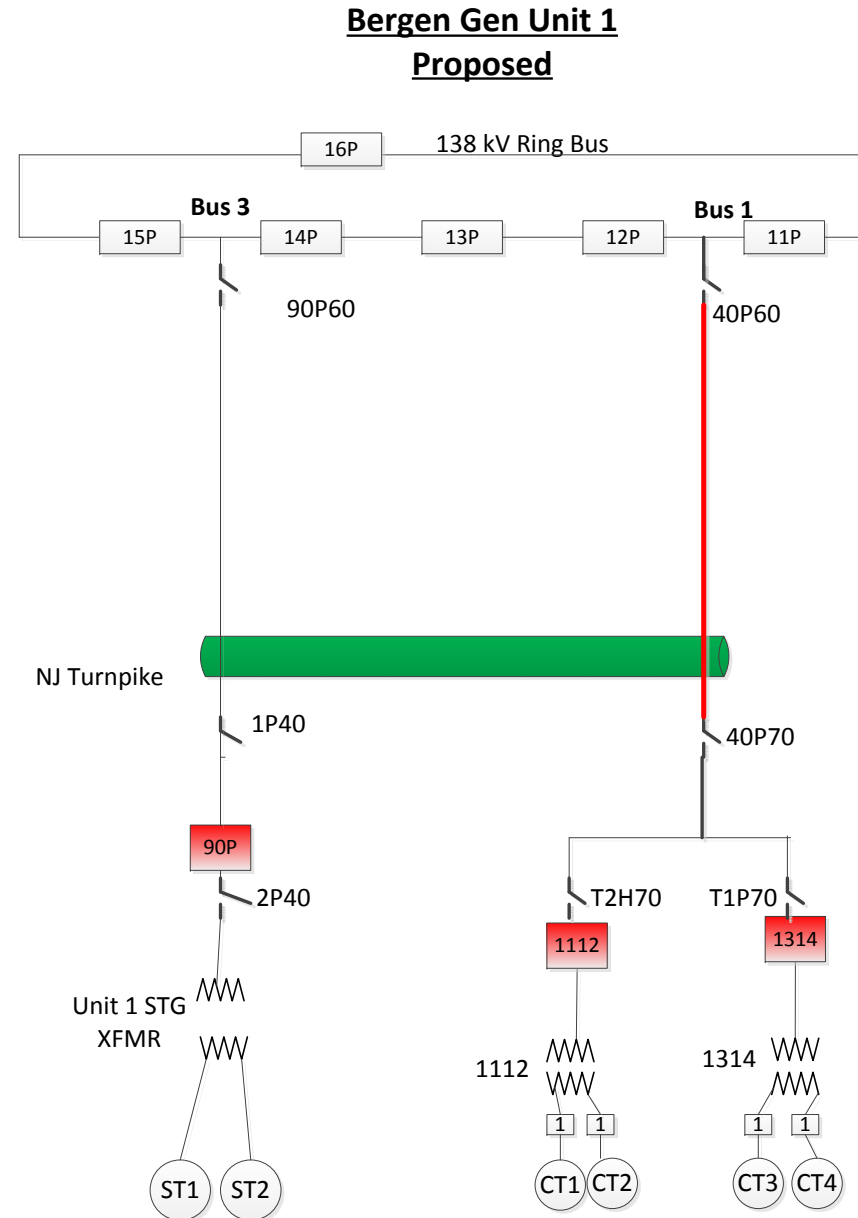

69kV Projects

Kearny 69kV breaker station

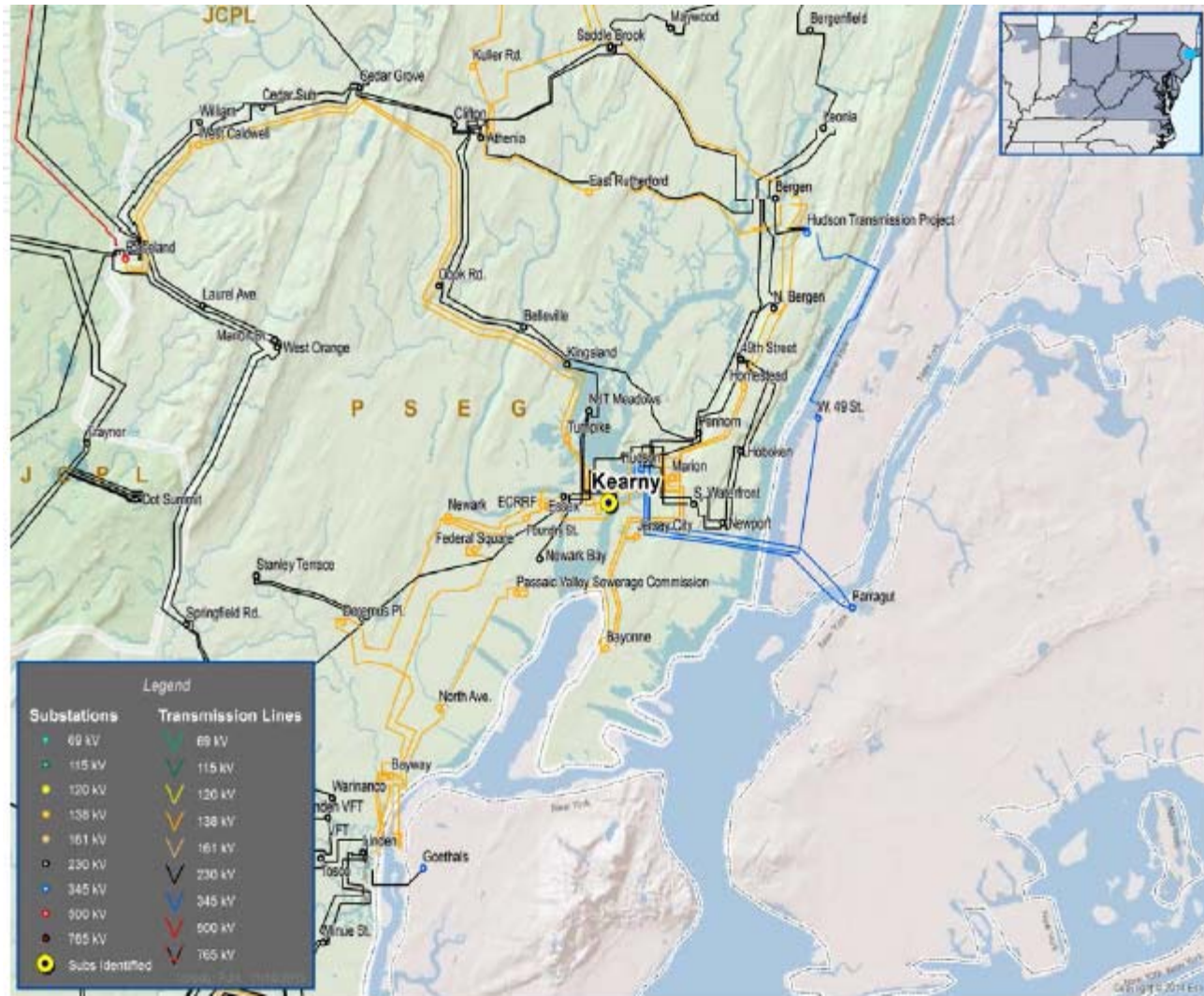

Kearny 69kV breaker station

Problem Statement:

- Increased load growth in Harrison St (projected to be overloaded by 2018) and Clay St. areas (projected to be overloaded by 2025) .
- 26kV service not sufficient to provide adequate capacity for the increased load.
- Harrison station has been in service since 1912 and Clay street has been in service since 1941.
- PSEG is addressing the aging 26kV infrastructure in Harrison St and Clay St and also the station overload problems by 69kV conversion. In addition to addressing overloads, this also ensures adequate capacity for future growth.

Proposed Solution:

- Build a new 230-69kV switching station in the area to provide added capacity.
- Build a three bay breaker and a half 69kV switching station.
- This new 69kV station will be in a central location to serve the load and also provide adequate capacity for future growth in the area.
- Build a new line from Kearny to Madison 69kV.

Alternative Considered:

- Upgrading existing substations is not feasible solution. It would require a larger equipment footprint than is available at the station. No additional property is available for station expansion. This area is also extremely congested and expanding the current 26kV will be very difficult.

Estimated Cost: \$125.1 M (Desktop Estimate – Includes 50% Risk and Contingency)

Scheduled IS Date: 12/31/2018

Project Status: Conceptual

Madison 69kV breaker station

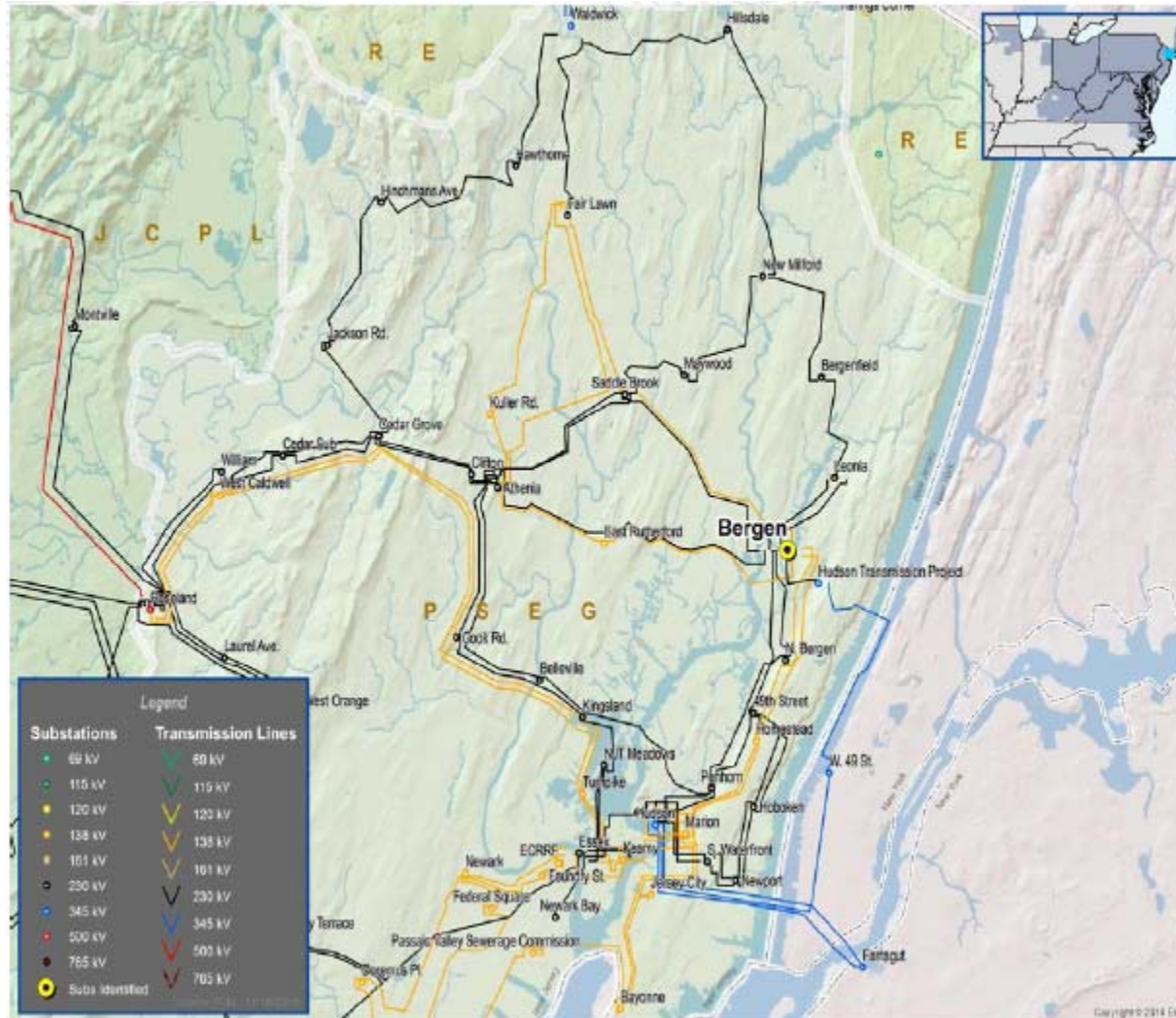

Madison 69kV breaker station

Problem Statement:

- Increased load growth in Jersey City area.
- Current Marion 26kV switching station that feeds Madison St and Marshall St stations will exceed its capacity by 2019. 26kV service not sufficient to provide adequate capacity for the added load.
- Madison and Marshall stations have been in service since 1955 and 1948 respectively, and reaching the end of their life cycles.
- Equipment damaged due to hurricane Sandy (entire station flooded at both Madison St and Marshall St stations).
- PSEG is addressing the aging 26kV infrastructure at Madison and Marshall St stations and the 26kV switching station overload problem at Marion 26kV station by 69kV conversion. In addition to addressing overload, this also ensures adequate capacity for future growth.

Proposed Solution:

- Build a new 230-69kV Madison switching station.
- Build a 8 breaker 69kV ring-bus and install four 69-4kV transformers.
- Build a new 69kV line from Madison 69kV to Union City 69kV.
- This will ensure that there is capacity for future growth and will address the overloaded condition in Marion 26kV switching station.

Alternative Considered:

- Upgrade existing switching station and rebuild 26kV circuits. This will be more costly compared to the proposed solution.

Estimated Cost: \$124.627 M (Desktop Estimate – Includes 50% Risk and Contingency)

Scheduled IS Date: 12/31/2018

Project Status: Conceptual

New Milford 69kV Breaker Station

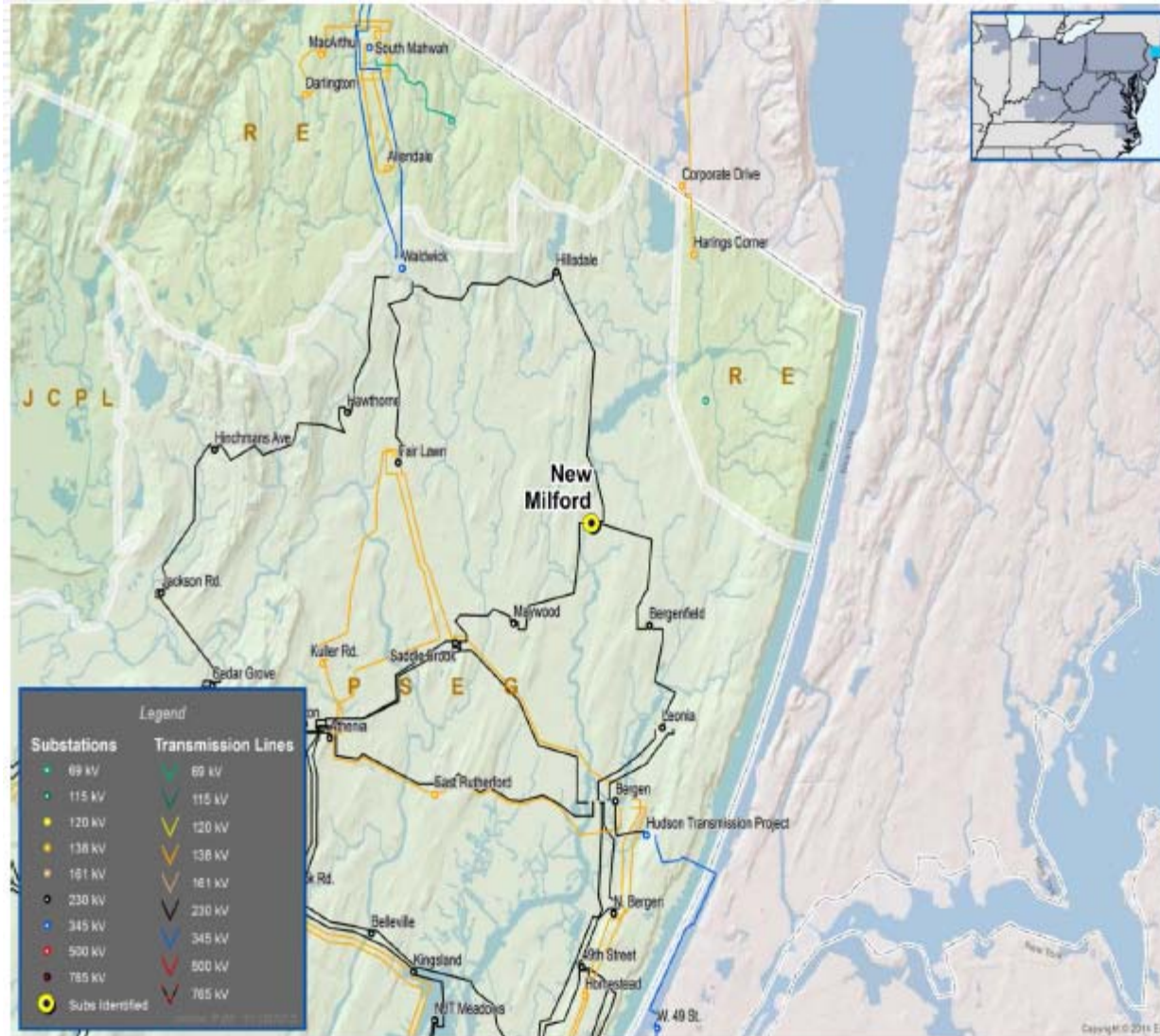

New Milford 69kV breaker station

Problem Statement:

- Increased load growth in Teaneck, Englewood and Dumont areas.
- Violation of PSEG N-1-1 criteria for Teaneck 69kV and Dumont 69kV.
- Introduces a new source station in the area to support future load growth.
- PSEG is addressing the aging 26kV overload problem in the New Milford area by 69kV conversion. This not only addresses aging infrastructure, but also ensures adequate capacity for future growth.

Proposed Solution:

- Build a new 230-69kV New Milford switching station.
- Install a new 230-69kV transformer.
- Build a new six(6) breaker 69kV ring-bus.
- Build a new line from New Milford 69kV to Teaneck 69kV.
- Build a new line from New Milford 69kV to Dumont 69kV.

Alternative Considered:

- Re-build the station and build a new switching station in the Teaneck, Englewood and Dumont vicinity. Some of the 26kV circuits will also need to be rebuilt to provide additional capacity. This would result in higher cost than the proposed solution.

Estimated Cost: \$79.7 M (Desktop Estimate – Includes 50% Risk and Contingency)

Scheduled IS Date: 12/31/2018

Project Status: Conceptual

Kingsland, Harrison and Van Winkle 69kV

Problem Statement:

- Increased load growth in Harrison and Van Winkle areas.
- Harrison St sub has been in service since 1912 and Van Winkle station has been in service since 1942.
- Current East Rutherford 26kV switching station that feeds Van Winkle station will be above its capacity by 2019.
- Currently there is a temporary 69kV in Kingsland.
- PSEG N-1-1 criteria violation at Harrison St substation.
- PSEG is addressing the 26kV overload problem in East Rutherford by 69kV conversion where deemed appropriate. This not only addresses overloads, but also ensures adequate capacity for future growth.

Proposed Solution:

- Build a new 230-69kV switching station. There is currently already a temporary 69kV station in Kingsland. This project will make it permanent.
- Build a new 69kV breaker and a half Van Winkle substation.
- Build a new 69kV line from Kingsland to Harrison.
- Build a new 69kV line from Kingsland to Van Winkle.
- Build a new 69kV line from Van Winkle to East Rutherford.

Alternative Considered:

- Upgrade existing switching station and rebuild 26kV. This would be more costly compared to the proposed solution.

Estimated Cost: \$138.5M (Desktop Estimate – Includes 50% Risk and Contingency)

Scheduled IS Date: 06/01/2019

Project Status: Conceptual

Ironbound 69kV

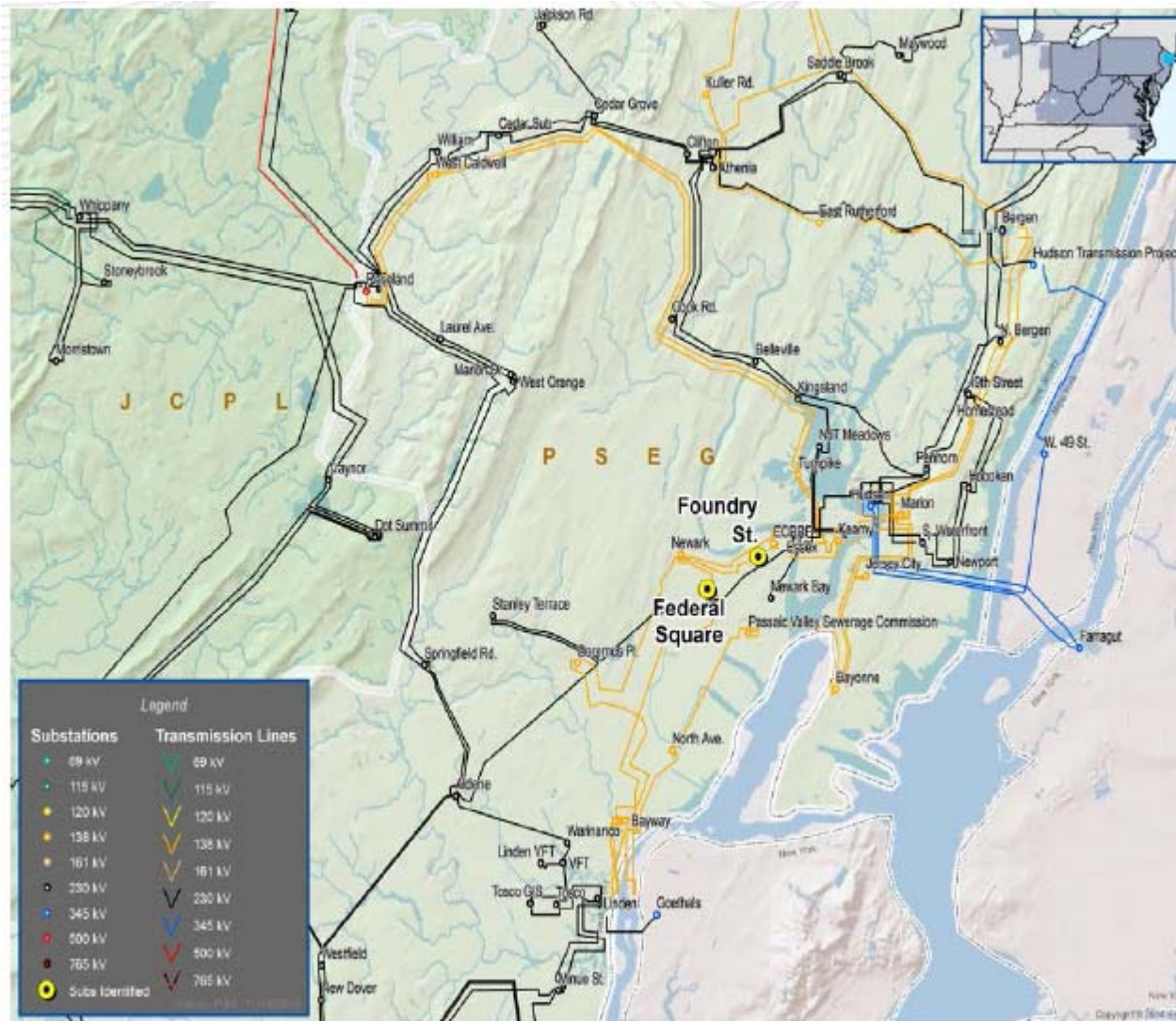

Ironbound 69kV

Problem Statement:

- Ironbound station has been in service since 1931.
- Existing equipment has reached the end of their life cycle.
- Spare/Replacement parts are difficult to acquire because of the equipment's age.
- Replace low capacity 26kV to ensure adequate capacity for future growth.

Proposed Solution:

- Build a new Ironbound 69kV station.
- Build a new 69kV station from Ironbound St. to Federal Square.
- Build a new 69kV station from Ironbound St to Foundry St.

Alternative Considered:

- Eliminate existing station by doing conversions. This option would be far more expensive than the proposed solution and will also result in possible neighboring station capacity violations.

Estimated Cost: \$75M (Desktop Estimate – Includes 50% Risk and Contingency)

Scheduled IS Date: 06/01/2019

Project Status: Conceptual

13kV Projects

Locust St. 69-13kV Transformers

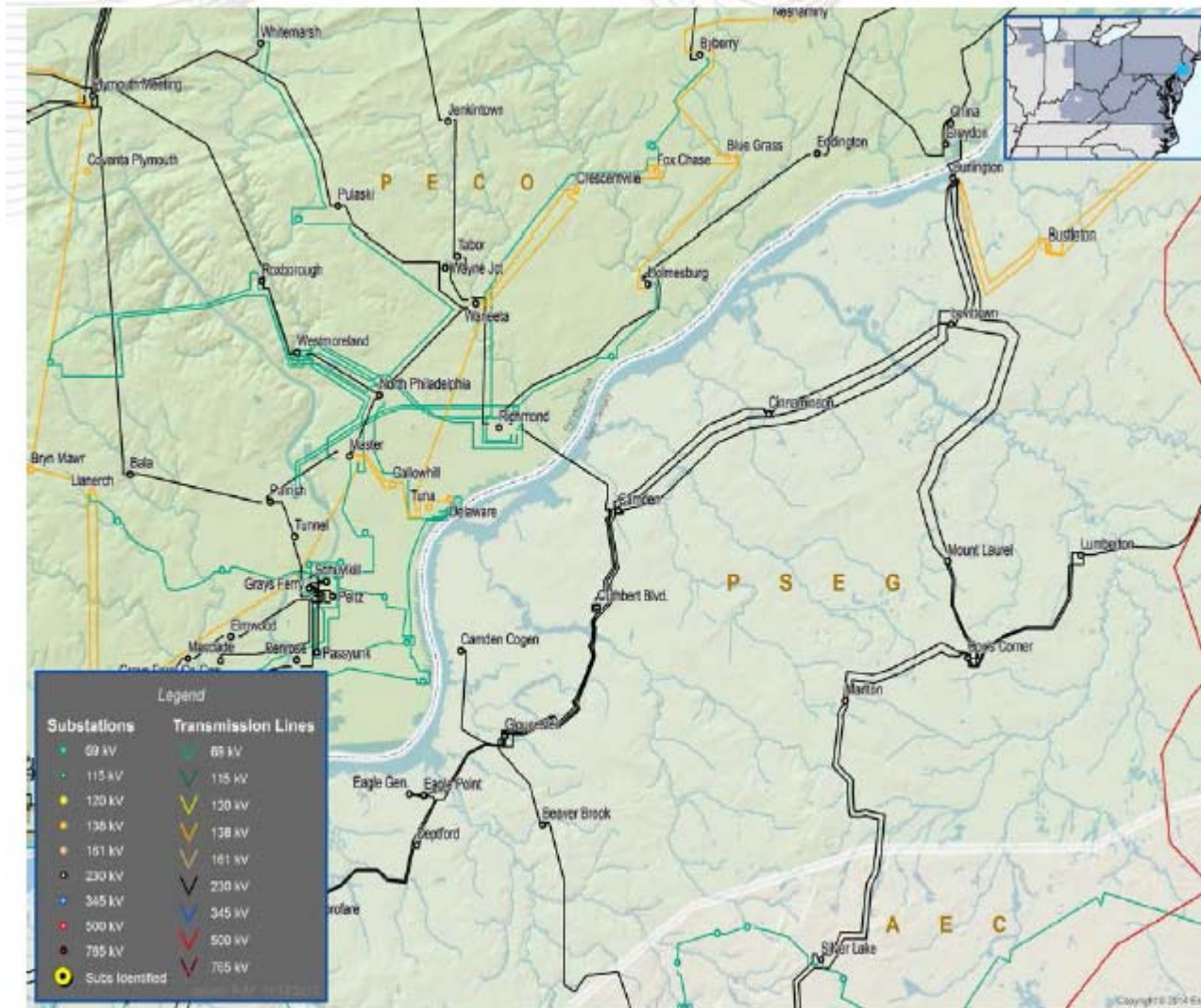

Locust St. 69-13kV Transformers

Problem Statement:

- Due to the proposed load growth as a result of the state economic development initiative for the Camden area, the existing Locust St. substation (located in a central location with respect to the future proposed customers) will not be able to accommodate the expected load growth.
- Currently, there are over 30 large commercial/industrial projects planned for this area.
- PSE&G has received load letters from several customers with an expected load of around 20 MW.
- The minimum expected load as a result of this load development is around 30 MW and the projected maximum load is in excess of 60 MW.
- All customers are expected to be in-service before June 2018.
- Existing Locust St. station and feeders are either at their maximum capacity or expected to be overloaded by 2018 (not including any new customers expected load).
- All other nearby stations and feeders are either at their maximum capacity or expected to be overloaded by 2018 (not including any new customers expected load).

Proposed Solution:

- Replace the existing limiting Locust Street two 69/4kV and three 69/13kV unit transformers with two 45/60 MVA 69/13kV transformers. (s1023)

Alternative considered:

- Since all the five substations in the vicinity of Locust St. are either at their maximum capacity or will be overloaded if they were to be utilized to supply the new projected customers (existing Locust St. unit transformers will be severely overloaded as well), replacing the limiting transformers at Locust St. was the most cost effective solution. Otherwise, major reinforcement will be needed for all nearby substations and circuits.

Estimated Cost: \$14.82 M (Desktop estimate including 50% risk & contingency)

Scheduled IS Date: 12/2017

Project Status: Conceptual

Transformers

Transformers

PSE&G's Transformer Life Cycle Replacement Program is designed to maintain system reliability through appropriate replacement of equipment as directed by condition assessment. Selection of replacement candidates is based on engineering review of transformer condition as part of our Condition Based Maintenance Program with consideration of Computerized Maintenance Management System (CMMS) Condition Assessment scores, the physical condition of the transformer, maximum and average age in each Peer Group and impact on customers and/or system in the event of failure.

Transformers

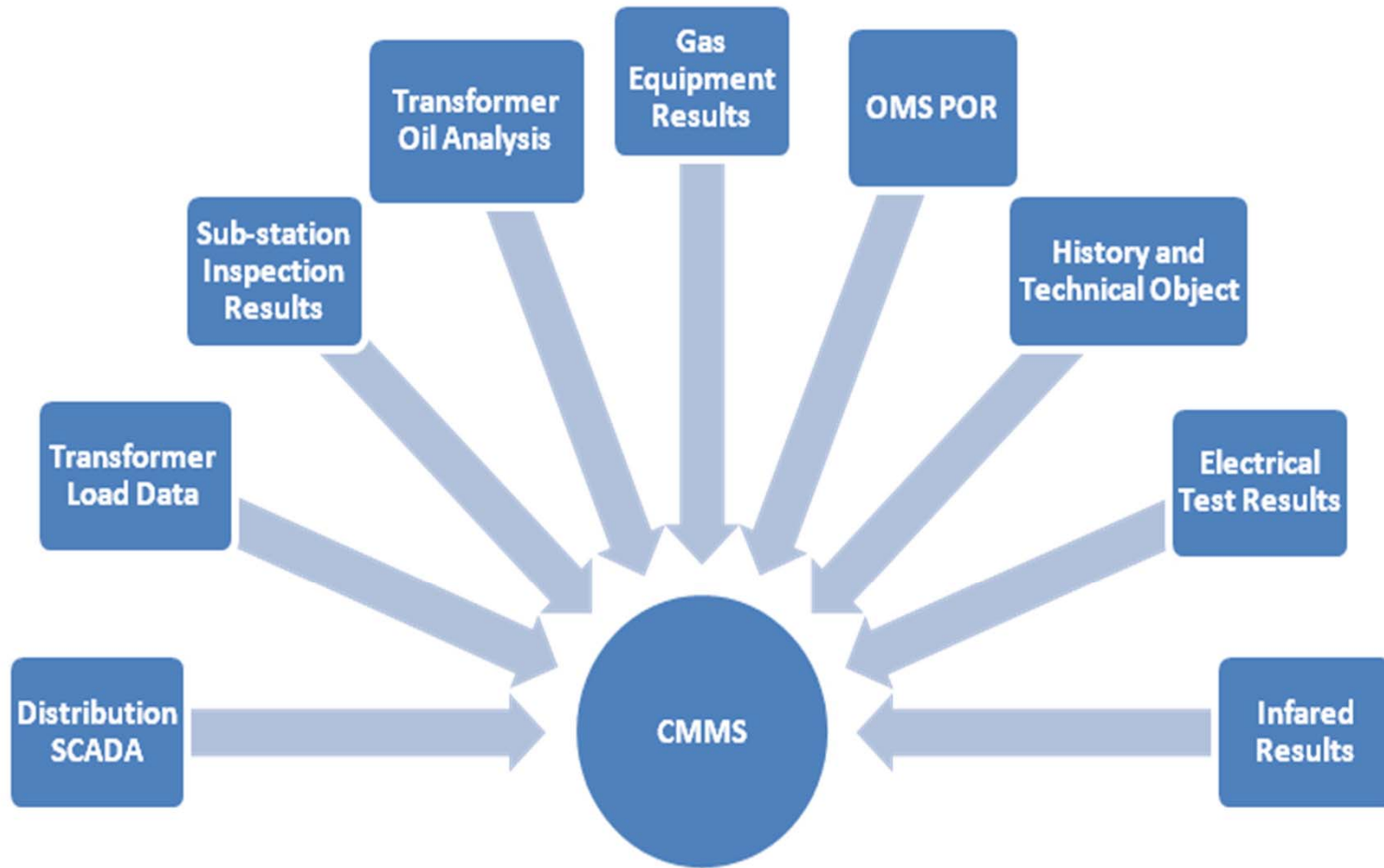

Transformers

Projects	PJM #	Costs	Age	Comments
West Caldwell T1/T3 138/13	s1007	9.8M	45 years	T1 & T-3 transformer Doble test results below acceptable limit for continued operations along with loading, Winding Temp >80 Deg C, insulation deterioration.
East Rutherford Sub T-10 /20	s1008	9.8M	45 years	T1 & T-3 transformer Doble test results below acceptable limit for continued operations along with loading, Winding Temp >80 Deg C, insulation deterioration.
System Spare transformer for system reliability BLC spare 750 MVA 345/138	s1010.3 & 4	22M		System Spare transformer for system reliability
System Spare transformer for system reliability 300 MVA 345/69, 150 MVA 345/26/13.8 345/13.8 kv 45 MVA	s1010.5, 6,7	19.9M		System Spare transformer for system reliability
Trenton Switch: The elimination of the 440 volt auxiliary power system. It is in poor condition and is being transferred to a new system at the station with capacity to handle the loads required.	s1014	2.2M	1937 vintage	De-commission whole 440 v system transferring loads to new Control House power.
Edison Switch: Build control house to house protective relaying and other operational controls due to the retirement of Edison Generating Station in June of 2015	s1018	10M		Eliminate reliance of third party generation power system that was retired in June of 2015. Emergency response was compromised during Sandy due to sharing of light and power.

Questions?