

Contents

| | |
|--|----|
| 1. Overview..... | 2 |
| 1.1 PJM Responsibilities | 3 |
| 2.3.3.2 Generation Schedules | 5 |
| 2.3.7 Mechanical/Technical Rules..... | 5 |
| 2.5.3.3 Real-time Security Constrained Economic Dispatch Methodology | 6 |
| 2.7 Locational Pricing Calculator (LPC)..... | 9 |
| 2.8 The Calculation of Locational Marginal Prices (LMPs) During Emergency Procedures ... | 11 |
| 2.9 Shortage Pricing..... | 12 |
| 2.14 Balancing Operating Reserve Cost Analysis | 13 |
| 3.1 Overview of the PJM Regulation Market..... | 15 |
| 3.2.1 Regulation Market Eligibility | 15 |
| 3.2.7 Regulation Market Clearing | 16 |
| 3.2.7.5 Total Offer | 16 |
| Section 4: PJM Reserve Markets..... | 16 |
| Section 4.1 Overview of the PJM Reserve Market..... | 16 |
| Section 4.2 PJM Reserve Market Offer Business Rules..... | 19 |
| Section 4.2.1 Reserve Market Resource Eligibility..... | 19 |
| Section 4.2.2 Reserve Resource Offer Requirements..... | 21 |
| Section 4.2.3 Reserve Market Resource Offer Structure..... | 22 |
| Section 4.2.4 Offer Period Timing | 25 |
| Section 4.2.5 Reserve Market Resource Capability | 25 |
| Section 4.3 Reserve Requirement Determination..... | 27 |
| Section 4.3.1 Locational Aspect of Reserves | 29 |
| Section 4.3.2 Creation of New Reserve Subzones | 30 |
| Section 4.3.3 Reserve Demand Curves and Penalty Factors | 30 |
| Section 4.4 Reserve Market Clearing..... | 32 |
| Section 4.4.1 Product and Locational Substitution..... | 32 |
| Section 4.4.2 Day-ahead Reserve Market Clearing..... | 33 |
| Section 4.4.3 Real-Time Reserve Market Clearing | 34 |
| Section 4.4.3.1 Deselection of Reserve Resources in Real-Time..... | 36 |
| Section 4.4.4 Opportunity Costs for Condensers..... | 37 |
| Section 4.4.5 Determination of Reserve Clearing Prices | 38 |
| Section 4.5 Event Performance..... | 41 |

| | |
|--|--------------------|
| Section 4.5.1 Performance Verification..... | 41 |
| Section 4.5.2 Non-Performance..... | 42 |
| Section 4.6 Reserve Obligations..... | 44 |
| Section 4.7 Bilateral Transactions..... | 44 |
| Section 4.8 Settlements..... | 45 |
| Section 5: Market Clearing Processes and Tools..... | 45 |
| 5.2.4 Markets Database System..... | 45 |
| Section 10: Overview of the Demand Resource Participation..... | 46 |
| 10.1 Overview of Demand Resource Participation..... | 46 |
| 10.2 Demand Resource Registration Requirements..... | 48 |
| 10.2.1 Registration Combinations..... | 48 |
| 10.4.1 Metered Data..... | 55 |
| 10.5 Aggregation for Economic, Pre-Emergency and Emergency Demand Resources..... | 56 |

1. Overview

Welcome to the Overview of Energy & Ancillary Services Market Operations of the PJM Manual for Energy & Ancillary Services Market Operations. In this section you will find the following information:

- A description of the scope and purpose of scheduling (see “Scope & Purpose of Energy & Ancillary Services Market Operations”).
- A list of the PJM responsibilities (see “PJM Responsibilities”).
- A list of the market participants’ scheduling responsibilities (see “PJM Market Participant Responsibilities”).

Scope & Purpose of Energy & Ancillary Services Market Operations Operation of the PJM RTO markets involves many activities that are performed by different operating and technical personnel. These activities occur in parallel on a continuous basis, 24 hours a day and can be grouped into three overlapping time frames:

- pre-scheduling operations
- scheduling operations and the Day-ahead Energy Market
- dispatching and the Real-time Energy Market

In the PJM Manual for Energy & Ancillary Services Market Operations we focus mainly on the activities that take place one day prior to the Operating Day including the activities associated with the Day-ahead Energy Market and in real-time associated with the Real-time Energy Market and Ancillary Service Markets. Generation resources, regardless of fuel type, fall into one of two categories, Capacity Resources or Energy Resources. If available, all Generation

Capacity Resources that have a Reliability Pricing Model (RPM) or Fixed Resource Requirement (FRR) Commitment must submit offer data into the Day-ahead Market and may elect either to Self-Schedule or offer the resource to PJM for scheduling as a PJM RTO-Scheduled Resource. In this section we focus primarily on the PJM Day-ahead Energy Market and the Reliability Assessment and Commitment (RAC) run process that takes place after the Day-ahead Energy Market is closed. Scheduling by PJM includes the Day-ahead Energy Market, the RAC run process and the Real-time Energy Market. The Day-ahead Energy Market bid/offer period closes at 1100 on the day before the Operating Day and the Day-ahead Market results are posted by 1330 or as soon as practicable thereafter on the day before the Operating Day. The RAC run process occurs throughout the day before the Operating Day. The Real-time Energy Market performs unit commitment and dispatch during the Operating Day. During the scheduling process, PJM:

- Clears the ~~Day-ahead Market and~~ Day-ahead Energy and Scheduling-Reserve Markets using least-cost security constrained resource commitment and dispatch that simultaneously optimizes energy and reserves.
- Determines a plan to reliably serve the hourly energy and reserve requirements of the PJM RTO by minimizing the cost to provide additional operating reserves above what was scheduled in the Day-ahead Market if required.
- Performs Real-time unit commitment and dispatch throughout the Operating Day as required.

PJM Members submit their bids according to either actual cost or offer price as designated by the Operating Agreement of PJM Interconnection, L.L.C. for each generation resource.

In this Manual, Locational Marginal Price (LMP) is defined as the marginal price for energy at the location where the energy is delivered or received. For accounting purposes, LMP is expressed in dollars per megawatt-hour (\$/MWh). In performing this LMP calculation, the cost of serving an increment of load at each bus from each resource associated with an eligible energy offer is calculated as the sum of the following three components of LMP: System Energy Price, Congestion Price, and Loss Price. In this Manual, unless otherwise specified, the terms “LMP” or “Locational Marginal Price” refer to the total LMP value including all three components. For information on the concept of LMPs, please refer to Section 2 of this Manual.

1.1 PJM Responsibilities

In the Day-ahead Market, PJM determines the minimum production cost of satisfying the Demand bids, Decrement bids, operating reserves and other ancillary services requirements of the market buyers, including the reliability requirements of the PJM RTO. In addition to the Day-ahead Market scheduling process, PJM also schedules resources to:

- Satisfy the reserve requirements of the PJM RTO by minimizing the cost to provide additional operating reserves above what was scheduled in the Day-ahead Market, if required.
- Provide other ancillary services requirements of the market buyers.

Manual 11 Reserve Price Formation Revisions – Redline

- Satisfy all other reliability requirements of the PJM RTO. Specifically, PJM’s responsibilities to support scheduling activities for all PJM Members include:

- o Develop the Day-ahead Market financial schedules based upon participant-supplied bids, offers and bilateral transaction schedules using least-cost security constrained resource commitment and dispatch analysis.

- o Post the following information after the Day-ahead Market clears:

- Schedules for Next Day by participant (generation & demand), – Transaction Schedules,
- Day-ahead LMPs, Day-ahead Congestion Prices, & Day-ahead Loss Prices
- Day-ahead Binding Transmission Constraints,
- Day-ahead Net Tie Schedules,
- Day-ahead Reactive 500 kV Interface Indicator Limits
- PJM Load Forecast,
- Aggregate Demand Bids
- PJM Day-ahead ~~Scheduling Reserve (Operating Reserve) Objective.~~ commitments

- Meet the PJM Forecasted load and reserves not covered by the Day-ahead demand bids, Self-Scheduled Resources or Bilateral Transactions, including scheduling generation to relieve expected transmission constraints.

In addition to resource scheduling PJM is also responsible to:

- Maintain data and information related to generation facilities in the PJM RTO as may be necessary to conduct the scheduling and dispatch of the PJM Interchange Energy Market and PJM RTO.

- Post the updated forecast of PJM Load and of the location and duration of any expected transmission congestion between areas in the PJM RTO.

- Revise schedule of resources to reflect updated projections of load, changing Bulk Electric System conditions, availability of and constraints of limited energy and other resources.

- Notify PJM stakeholders of any new closed loop interface implementation as far in advance as possible with a target notice of five (5) days prior to the next Financial Transmission Rights (FTR) auction close. Notification is communicated through posting on www.pjm.com – OASIS System Information and e-mail to the MIC and OC email distribution lists. Exceptions to this are limited to estimated short duration planned, emergency or maintenance outages, (e.g., < ten (10) days) to set price, or to allow Demand Response (DR) to set price if a transmission limitation exists as defined in the PJM Tariff and Manuals. The posting will include the interface name, effective date, estimated termination date (if applicable), whether included in Day-ahead model, whether included in the FTR model, conditions when use is applicable, general description, interface definition/branch names and directions, whether it will set price for DR, generation, or both and any revision history. PJM will post interface definition with network model map-able branch names in CSV or XLS format. In addition PJM will provide notice when PJM is studying if a new closed loop interface may be defined and any information regarding the modeling of such prospective closed loop interface.

2.3.3.2 Generation Schedules

Operating Limit Business Rules

- The priority of generator offer operating limits are as follows: (1) Unit Hourly MW limits (Markets Gateway>Generator>Unit>Hourly), (2) Daily Unit Schedule Limits (Markets Gateway>Generator> Schedules>Detail), and (3) Unit limits (Markets Gateway>Unit>Detail). Daily unit schedule MW limits can be overridden by unit hourly MW limits. Weather curves for CTs apply to both unit limits and schedule limits.
- Certain Operating Limit parameters are subject to limitations as defined in Section 2.3.4 of this Manual.
- ESR model participants use economic/emergency minimum/maximum charge and discharge limits to represent their operating range to PJM. In the context of the ESR participant model, any references to economic and emergency limits can be translated to generator limits, under the three (3) different operating modes, as follows:
 - A unit bid includes a ramp rate, which is the MW/Minute increase or decrease of a unit being offered for economic dispatch. The ramp rate shall be based on the actual capability of the unit given the confines of the PJM software and shall not be used to withhold a portion of the capacity or ramping capability of a unit from the market. Hourly ramp rates must be updated regularly to account for latest ambient conditions
 - Hourly differentiated segmented ramp rates allow Generation Resources to reflect their ramping capability with greater granularity compared to a single ramp rate or daily segmented ramp rates. Generation Resources with discontinuities in their operating rate (e.g. duct burners, peak firing) should use hourly differentiated segmented ramp rates to reflect such operating modes.

2.3.7 Mechanical/Technical Rules

A valid generator offer consists of the following elements:

- Use startup & no-load switch, with a default value of yes (1).
- Hourly startup and no-load costs, with default values of zero.
 - o External resources can only submit startup and no-load costs if the entire output of the resource is available for PJM dispatch.
- Ramp rate, with a default value of 9999 MW/minute
- Condense available switch, with a default value of no (0).
- Hourly economic max/min and emergency max/min are the unit-level economic and emergency MW limits, respectively.

Manual 11 Reserve Price Formation Revisions – Redline

- Daily minimum down time and start times, with default values of zero.
- Daily minimum run time and notification time for the Day-ahead Market, with the ability to update the hourly values for use in Real-time commitment and dispatch. The default values will be zero
- Daily maximum run time and maximum number of starts per week, with default values of infinity.
- Use offer slope switch, with a default value of no (0).
- Hourly incremental offer curves, with default value of \$0. If the last MW point on the segment curve is less than the maximum emergency limit, then the curve is extended up to the emergency maximum limit using zero slope from the last incremental point on the curve.
- For those parameters that are allowed to vary hourly, in the absence of overrides specifying separate values for each hour (hourly differentiated offer data), the daily offer value is used.
- In order to qualify for exempt or bonus MW during a Performance Assessment Interval, in accordance with PJM Manual 18: PJM Capacity Market, Section 8.4A NonPerformance Assessment, each generation resource must have at least one available schedule. Each offer must have the following:
 - o Economic Minimum value (zero or non-zero value).
 - o Economic Maximum value (zero or non-zero value).
 - o Emergency Maximum value (zero or non-zero value).
 - o At least one segment on the incremental offer curve.

Valid offers for a Generation Capacity Resource consists of a parameter limited price-based schedule (if the resource is price-based) and at least one cost-based schedule.

Valid offers for a non-Capacity Generation Resource consists of a price-based schedule (if the resource is price-based) and at least one cost-based schedule.

Valid offers for demand bids, price sensitive and fixed, consist of the following items:

- MW, with a default value of 0 MW. Demand bids should not include losses.
- Location (transmission zone, aggregate, or single bus). Price at which the demand shall be curtailed (for price-sensitive bids).

2.5.3.3 Real-time Security Constrained Economic Dispatch Methodology

The future target dispatch time or target time is eight (8) to ten (10) minutes from the program's execution time rounded up to the nearest five (5) minute segment of time. The ten (10) minute future target dispatch time is divided into two five (5) minute segments. During the initial five (5) minute segment, RT SCED shall calculate an Achievable Target Megawatt (ATM), which utilizes the previous dispatch instructions, latest State Estimator (SE) data and bid in operating parameters to determine where the unit is most likely to be operating at the end of the first five minutes.

The ATM is calculated by determining an achievable output band, which takes the reported SE MW value (represents where the unit is operating) and uses the bid in ramp rates to determine where the unit can get to in the next five minutes.

- When the previous dispatch instruction is within the achievable output band, the ATM is set to the previous dispatch MW value.

Manual 11 Reserve Price Formation Revisions – Redline

- When the previous dispatch instruction is below the achievable output band, the ATM is set to the floor of the achievable output band.
- When the previous dispatch instruction is above the achievable output band, the ATM is set to the ceiling of the achievable output band.
- If previous dispatch instructions are not available, the ATM is set to the SE MW value.

The second five (5) minute segment uses the calculated ATM as a starting point, and ramps the resource over the remaining five (5) minute time period to meet the load and reserves.

The general formula is as follows:

- Achievable Target MW
= Min(Max(previous Case Dispatch,
(SE MW - (~~previous~~current down ramp rate) * 5)), (SE MW + (~~previous~~current up ramp rate) * 5))
- Where:

Previous case dispatch Dispatch Signal from the previous approved RTSCED case

SE MW State Estimator output

~~**Previous Down Ramp Rate** Down ramp rate from the previous approved RTSCED case~~

~~**Previous Up Ramp Rate** Up ramp rate from the previous approved RTSCED case~~

~~**Current Down Ramp Rate** Down ramp rate determined at the time the Real-Time case is executed~~

~~**Current Up Ramp Rate** Up ramp rate determined at the time the Real-Time case is executed~~

- The following diagrams illustrate this process:

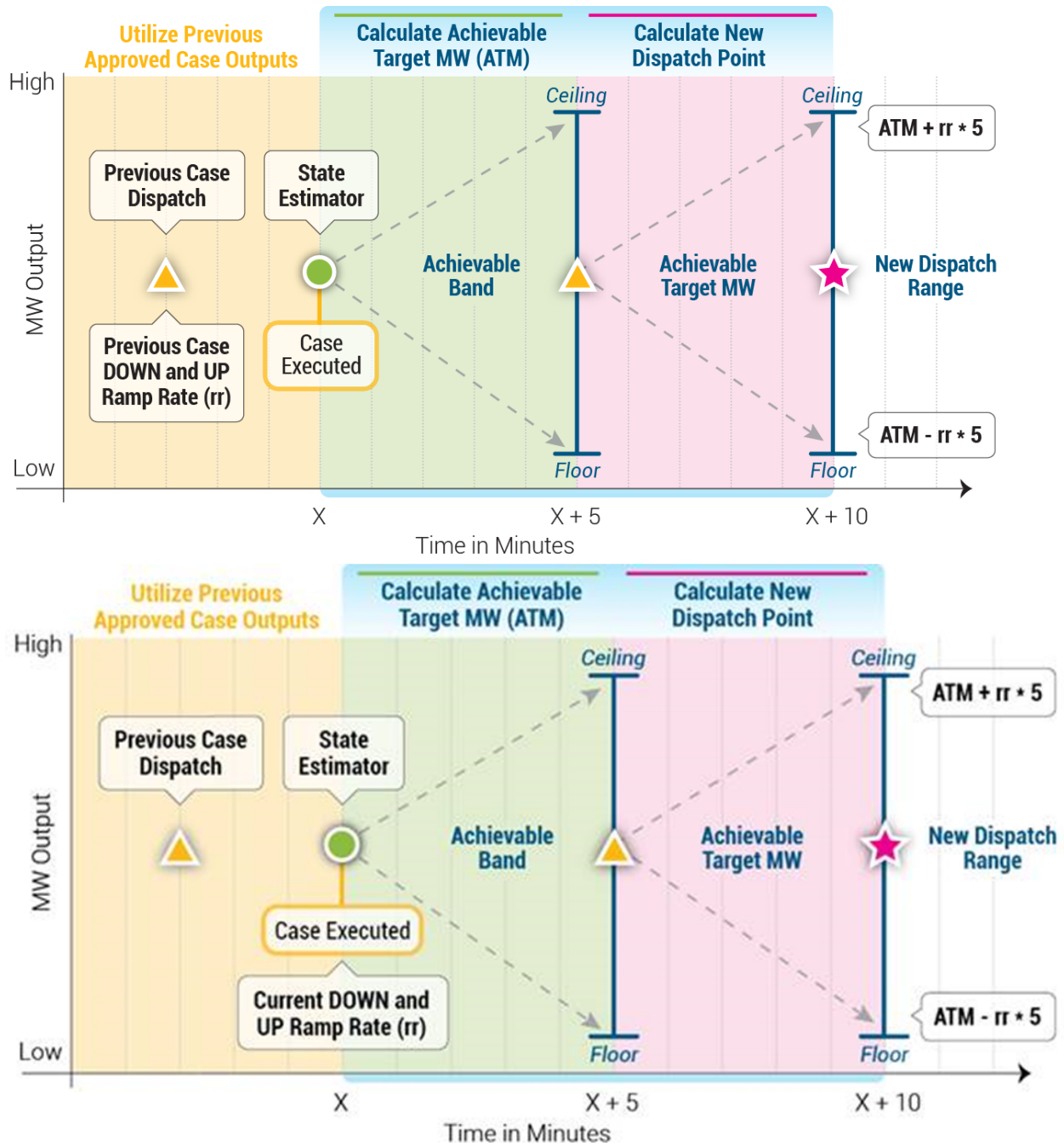

In this example, RT SCED executes a case at X minutes (indicated by the green circle). Simultaneously, RT SCED “looks back” at the previous RT SCED case dispatch basepoint (indicated by the yellow triangle) to determine whether the unit can achieve the instruction. Because the previous RT SCED case dispatch basepoint is within the achievable output band (indicated by the grey arrows in the green segment), RT SCED will use the previous dispatch basepoint as the starting point for the second five-minutes (the dispatch interval), and ramp up or down as necessary within the resulting feasible range (indicated by the grey arrows in the pink segment) over the subsequent five minutes.

If RT SCED “looks back” and determines that the resource’s previous dispatch basepoint is not within the achievable band, RT SCED will use a new dispatch basepoint as the starting point for the second five minutes, which will be either the “ceiling” or the “floor” of the achievable band from the first five minutes depending on whether the previous instruction was above or below the achievable band. These scenarios are illustrated by the following diagram.

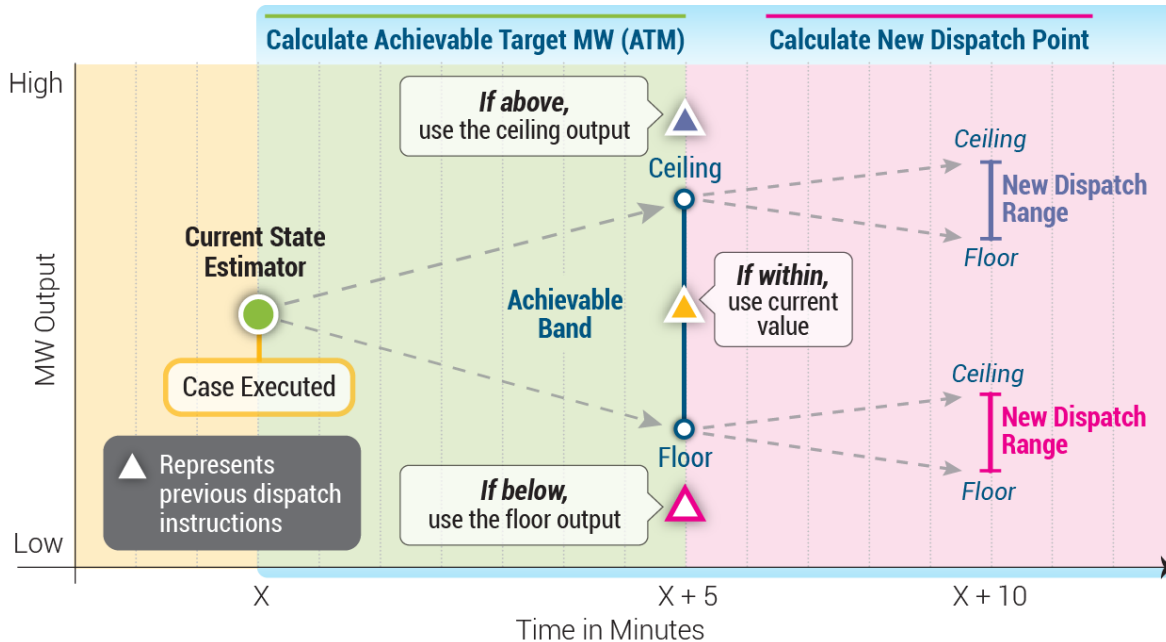

In this example, RT SCED “looks back” over the previous interval, and determines that the previous dispatch basepoint is above the “ceiling” of its achievable output band (indicated by the purple triangle and grey arrows in the green segment). As a result, RT SCED establishes the “ceiling” of the achievable band as the new dispatch basepoint for the second five-minute segment of the ten-minute look-ahead, and creates a new dispatchable range (indicated by the grey arrows in the upper half of the pink segment). A parallel example using the “floor” is also illustrated for reference.

Historical and current system information is used to anticipate generator performance to various requests, and to provide accurate information regarding generator operating parameters under multiple scenarios.

The results from the approved RT SCED are Energy Dispatch Signals, [Tier 2-Synchronized Reserve commitments](#), ~~and~~ [Non-Synchronized Reserve commitments](#) ~~and~~ [Secondary Reserve commitments](#) that are sent to resource owners in Real-time. All dispatch instructions may change with each solution based on system economics and reserve requirements.

2.7 Locational Pricing Calculator (LPC)

The function of the Locational Pricing Calculator (LPC) is to determine the Real-time LMP values and Regulation and Reserve Clearing Prices on a five (5) minute basis. The LPC engine performs a pricing run solution where Integer Relaxation is applied to eligible Fast-Start

resources only for the purposes of calculating LMPs and Ancillary Service MCPs. Real-time LMPs and Regulation and Reserve Clearing Prices are derived from the inputs of the latest approved Real-time Security Constrained Economic Dispatch (RT SCED) program solution, referred to as the reference case, for the target time at the end of the current five (5) minute interval. If there is not an approved RT SCED solution for the target time at the end of the current five (5) minute interval, LPC will use the most recent approved RT SCED solution prior to the target time as the reference case. LPC will use the offered in parameters for Energy and Reserves from the reference case as inputs as well as offered in parameters for Regulation that are effective at the target time for each LPC case solution. The Real-time LMPs and Regulation and Reserve Clearing Prices calculated by LPC are applied to each five (5) minute Real-time Settlement Interval ending at the LPC target time. In the event of an outage to RT SCED, the LPC will use the RT SCED case that best represents the conditions over the outage period as determined by the Market Operator. The LPC calculates LMPs for each of the PJM nodes in the state estimator model and for interface busses used as a proxy for transfers to and from PJM and external control areas. The Real-time LMPs are defined as the cost to serve the next increment of load at each node, in the LPC pricing run, taking into account eligible resource Real-time offer prices and the nodes' location with respect to transmission limitations and incremental system losses. The LPC is an incremental linear optimization program that is formulated to jointly optimize and price both Energy and Reserves. The objective is to minimize the cost function including the cost of Energy and Reserves subject to the power balance constraint, the Synchronized, ~~and~~ Primary, ~~and~~ 30-minute Reserve Requirements, specific generator and Demand Resource operating limitations, except in cases in which Integer Relaxation is applied, transaction MW limits, and any transmission constraints that currently exist on the system and a normalized distribution of system losses to a network location.

Every five (5) minutes the LPC calculates:

- Locational Marginal Prices (LMPs).
- Synchronized Reserve Market Clearing Prices (SRMCPs).
- Non-Synchronized Reserve Market Clearing Prices (NSRMCPs).
- Secondary Reserve Market Clearing Prices (SecRMCPs).
- Regulation Market Clearing Prices (RMCPs) and Regulation Market Performance Clearing Prices (RMPCP), which are then used to derive the Regulation Market Capability Clearing Price (RMCCP).

Each Energy and Reserve clearing price is calculated as the cost to serve the next MW of demand for each individual product considering its impact on the others. For example, LMPs are calculated such that they reflect the cost to serve the next MW of Energy demand in each location while considering the impact of that additional MW of Energy on the ability to meet the Primary Reserve, ~~and~~ Synchronized, ~~and~~ 30-minute Reserve Requirements. Regulation Clearing Prices are calculated as the cost of the last resource committed to meet the Regulation Requirement, as further described in Section 3 of this Manual.

2.8 The Calculation of Locational Marginal Prices (LMPs) During Emergency Procedures

In order to properly calculate LMPs during Emergency Procedures, PJM performs the following functions to ensure that deployed or purchased emergency capacity is eligible to set LMPs within PJM.

Pre-Emergency and Emergency Demand Response

- Pre-Emergency or Emergency Demand Response are deployed by lead time, by product, and/or by transmission zone or transmission subzone.
- PJM dispatches the resources of all Pre-Emergency or Emergency Load Response Program participants (not already dispatched under the Economic Load Response Program) based on the availability, location, dispatch price and/or quantity of load reduction needed, subject to transmission constraints in the PJM Region.
 - To give PJM dispatchers the flexibility to address reliability concerns in the most effective and timely manner and invoke the resources that offer the most assurance of effective relief of emergency conditions, the dispatch of Demand Resources may not be solely based on the least-cost resources since such dispatch shall be based not only on price, but also on availability, location and/or quantity of megawatts of load or load reduction needed.
 - o Resources in the Full Program Option and Energy Only Option in the Pre-Emergency or Emergency Load Response Program are eligible to set the Real-time LMP when PJM has dispatched the resources and such resources are required to reduce demand in the PJM Region.
 - o PJM treats Pre-Emergency and Emergency Demand Response similar to a dispatchable generator for the purpose of determining whether it is marginal.
 - PJM uses operational data submitted by CSPs to determine the availability and actual response of Pre-Emergency and Emergency Load Response.

Maximum Emergency Generation

- Generators who have designated all or portions of the output of their unit as max emergency are eligible to set price.
- Max emergency output is only eligible to set LMP if PJM Operators have loaded Maximum Emergency Generation.

Emergency Purchases

- PJM allows emergency purchase transactions to set LMP to the extent they are required to clear the Energy and Reserve Markets.
- Emergency Purchases are treated similar to the dispatchable generator for the purpose of determining whether they are marginal or not.
 - If determined to be marginal, an Emergency Purchase sets price at the lesser of its offer price or the applicable offer cap stated in Section 2.3.2 of this Manual.

In the event that PJM initiates a voltage reduction or manual load dump to maintain system reliability:

- All Reserve Clearing Prices in the region where the voltage reduction and/or manual load dump were initiated are set consistent with a shortage of the first step on the demand curve.
 - Synchronized Reserve Clearing Price = Synchronized Reserve Penalty Factor + Primary Reserve Penalty Factor + 30-minute Reserve Penalty Factor (capped at 2 * Penalty Factor)
 - Non-Synchronized Reserve Clearing Price = Primary Reserve Penalty Factor + 30-minute Reserve Penalty Factor (capped at 1.5 * Penalty Factor)
 - Secondary Reserve Clearing Price = 30-Minute Reserve Penalty Factor
 - ~~Non-Synchronized Reserve Clearing Price = Primary Reserve Penalty Factor~~
 - ~~Synchronized Reserve Clearing Price = Primary Reserve Penalty Factor + Synchronized Reserve Penalty Factor~~

The LMPs and Reserve Clearing Prices in the location that the voltage reduction and/or manual load dump was initiated are calculated consistent with all reserve products in that region being short until such emergency conditions are terminated as defined in PJM Manual 13: Emergency Operations.

Shortage pricing is terminated in a Reserve Zone or Reserve Sub-Zone when demand and Reserve Requirements can be fully satisfied with generation and Demand Resources and any Voltage Reduction Action and/or Manual Load Dump Action taken for that Reserve Zone or Reserve Sub-Zone is terminated as determined by the Locational Pricing Calculator.

2.9 Shortage Pricing

If during the execution of the pricing run, the Locational Pricing Calculator determines that a ~~Primary Reserve Shortage and/or a Synchronized Reserve Shortage~~ exists as further described in Sections 2.8 and 4.2 of this Manual, PJM shall deem this to be a ~~Primary Reserve Shortage and/or a Synchronized Reserve Shortage~~. PJM shall implement shortage pricing through the inclusion of the applicable ~~Primary Reserve and/or Synchronized Reserve~~ Penalty Factors in the Real-time LMP and reserve pricing calculations.

Shortage pricing shall exist until the Locational Pricing Calculator determines the specified Reserve Requirements can be met and no Voltage Reduction Action or Manual Load Dump Action is still in effect.

If a ~~Primary Reserve Shortage and/or Synchronized Reserve Shortage~~ exists and cannot be accurately forecasted by the Office of the Interconnection due to a technical problem with or malfunction of the RT SCED and/or LPC software programs, including but not limited to program failures or data input failures, PJM utilizes the best available alternate data sources to determine if a Reserve Zone or Reserve Sub-Zone is experiencing a ~~Primary Reserve Shortage and/or a Synchronized Reserve Shortage~~.

All shortages observed in the LPC pricing run will be provided to settlements for billing purposes.

~~The maximum LMP achievable during a Reserve Shortage is the \$2,000/MWh energy offer cap, plus the Primary Reserve and Synchronized Reserve Penalty Factors from the first step on the demand curves, plus or minus congestion and marginal loss impacts.~~

The maximum energy component of LMP achievable during a Reserve Shortage is the \$2,000/MWh energy offer cap, plus \$1,700/MWh (two times Penalty Factors from the first step on the demand curves).

2.14 Balancing Operating Reserve Cost Analysis

~~Accounting for Operating Reserve is performed on a daily basis. A pool-scheduled resource of a PJM Member is eligible to receive credits for providing Operating Reserve in the Day-ahead Market and, provided that the resource was available for the entire time specified in its offer data, in the Real-time Market. The total resource offer amount for generation, including startup and no-load costs as applicable, is compared to its total Energy Market value for specified operating period segments during the day (including any amounts credited for Day-ahead Scheduling Reserve in excess of the Day-ahead Scheduling Reserve offer, any amounts credited for Synchronized Reserve in excess of the Synchronized Reserve offer plus opportunity cost, any amounts credited for Non-Synchronized Reserve in excess of the Non-Synchronized Reserve opportunity cost and any amounts credited for resources providing Reactive Services). If the total value is less than the offer amount, the difference is credited to the PJM Member.~~

~~Nuclear Units are excluded from eligibility for Operating Reserve credits except in cases where PJM requests that nuclear units reduce output at PJM's direction or where a physical problem at a nuclear unit requires a risk premium and that risk premium is submitted to and accepted by the MMU. Other specific circumstances will be evaluated on a case-by-case basis by PJM and the MMU.~~

Fees are also provided for pool-scheduled energy transactions, for generating units operating as synchronous condensers (not for Synchronized Reserve nor for Reactive Services) at the direction of PJM, for cancellation of pool-scheduled resources, for units whose output is suspended or reduced due to a transmission constraint or other reliability reason, for units performing an annual black start test, and for units providing Reactive Services at the direction of PJM.

The offered price for pool-scheduled resources will be capped for the entire Operating Day in the event either of the following conditions exist:

- The generation resource is identified in the Day-ahead schedule to be dispatched out of economic merit order to control an identified transmission constraint.
- The generation resource is dispatched to provide quick start reserve for reliability

Manual 11 Reserve Price Formation Revisions – Redline

In the event one of the above conditions exists, the offer prices will be capped at one of the following three levels, as specified in advance by the resource owner:

- The weighted average Real-time Locational Marginal Price at the generation bus during all hours over the past six (6) months in which the resource was dispatched in economic merit order above minimum.
- The incremental operating cost of the generation resource as determined by PJM Manual 15: Cost Development Guidelines plus the lesser of a 10% adder or \$100.
- An amount negotiated between PJM and the Market Seller in the event the generation resource cannot recover costs with either of the first two methods above.

~~The total cost of Day-ahead Operating Reserve for the Operating Day, excluding the total cost for resources scheduled to provide Black Start Service, Reactive Service, or transfer interface control is allocated and charged to PJM Members in proportion to their total cleared Day-ahead demand and decrement bids plus their cleared Day-ahead exports for that Operating Day. The total cost of Balancing Operating Reserve, excluding the total cost associated with scheduling units for Black Start service or testing of Black Start units, for the Operating Day is allocated and charged to PJM Members in proportion to their locational real-time deviations from Day-ahead schedules and generating resource deviations during that Operating Day, or to PJM Members in proportion to their Real-time load plus exports during that Operating day for generator credits provided for reliability.~~

~~In order to determine the reason why the Operating Reserve credit has been earned so that the charges related can be properly allocated, PJM conducts a Balancing Operating Reserve Cost Analysis (BORCA). PJM also calculates a Regional Balancing Operating Reserve rate for the costs of Operating Reserves that result from actions to control transmission constraints that are solely within pre-defined regions in the RTO. Additional costs of Operating Reserves that result from actions to control transmission constraints that benefit the entire RTO will continue to be allocated equally to deviations across the entire RTO. The total cost of synchronous condenser payments (other than that for Synchronized Reserve or Reactive Services) for the Operating Day is allocated and charged to PJM Members in proportion to their total load plus their exports during that Operating Day. The total cost of Reactive Services for the Operating Day is allocated and charged to PJM Members in proportion to their total load in the applicable transmission zone. The total cost of Day-ahead Operating Reserve for the Operating Day for resources scheduled to provide Reactive Services or transfer interface control because the resource is known or expected to be needed to maintain system reliability in a zone(s) are allocated and charged to PJM Members in proportion to their total Real-time load in the applicable transmission zone(s). The total cost of Operating Reserves for resources providing Black Start service or testing of Black Start units is allocated to Network and Point-to-Point Transmission Customers based on their monthly transmission use on a megawatt basis. Additional details on this allocation can be found in the Black Start Service Accounting section of PJM Manual 27: Open Access Transmission Tariff Accounting.~~

The purpose of the BORCA is to separate those Balancing Operating Reserve charges to be allocated to deviations between Day-ahead schedules and Real-time quantities from those that should be allocated to Real-time load and exports. The key factor in separating the allocation is the determination of the particular units by which Balancing Operating Reserve Credits were

Manual 11 Reserve Price Formation Revisions – Redline

earned, and the units for which those credits should be allocated to deviations as opposed to those units for which those credits should be allocated to load and exports. This cost determination will occur in two stages: those units called on during the Reliability Analysis, and those units called on to operate during the Operating Day. In both cases, the following criteria is applied to such units to determine the reason Balancing Operating Reserve credits were earned.

For resources scheduled by PJM during its Reliability Analysis for an Operating Day, the associated Balancing Operating Reserve charges are allocated based on the reason the resource was scheduled.

- If the resource is committed to operate in Real-time to augment the physical resources committed in the Day-ahead Energy Market to meet the forecasted Real-time load plus the Operating Reserve Requirement, then in such cases, Balancing Operating Reserve charges will be allocated to Real-time deviations from Day-ahead schedules. •
- If however, a resource is scheduled by PJM during its Reliability Analysis not to account for anticipated deviations between Day-ahead schedules and Real-time conditions but instead to provide additional reliability margin, Balancing Operating Reserve charges must be allocated to Real-time load plus exports.

For resources called on by PJM to operate during the Operating Day, the associated Balancing Operating Reserve charges are allocated based on the reason the resource was scheduled.

- Balancing Operating Reserve credits earned by units called on by PJM to operate during the Operating Day for which the LMP at the unit's bus does not meet or exceed the unit's applicable offer (cost or price) for at least four (4), five (5) minute intervals of at least one clock hour during which the unit was running at PJM's direction will be allocated according to ratio share of load plus exports.
- Balancing Operating Reserve credits earned by all other units operating at PJM's direction in Real-time will be allocated according to deviations between Day-ahead schedules and Real-time quantities. The logic behind this distinction is that units called on in Real-time for which LMP exceeds their offer for a significant number of intervals while they are running are necessary to meet load requirements respecting active transmission constraints.
- Units called on at PJM's direction in Real-time for which the LMP does not exceed the unit's offer were not needed and were therefore operating in order to ensure reliability is maintained as opposed to account for differences between Day-ahead schedules and Real-time system conditions.
- PJM further collects Balancing Operating Reserve credits that are accrued to resources operating to manage local transmission constraints. In order to appropriately collect the costs of Balancing Operating Reserve for local constraints within the pre-determined regions where the constraints existed, PJM calculates Regional Balancing Operating Reserve adders.
- PJM calculates Regional Balancing Operating Reserve adders for the following Regions within the PJM RTO.
 - Western Region of the PJM RTO, comprised of the AEP, APS, ATSI, ComEd, Duquesne, Dayton, DEOK, EKPC, and OVEC Zones.

- Eastern Region of the PJM RTO comprised of the AEC, BGE, Delmarva, Dominion, PENELEC, PEPCO, ME, PPL, JCPL, PECO, DPL, PSEG, and RE Zones.
- Generation resources with market based offers greater than \$1,000/MWh in the Day-ahead and Real-time Energy Market that are also greater than the resource’s lowest available and applicable cost-based offer are not eligible to receive Balancing Operating Reserve Credits.

Balancing Operating Reserve credits that are accrued to resources operating to control transmission constraints that benefit the entire RTO are charged as an RTO Balancing Operating Reserve rate. See “Operating Reserve Accounting” section of PJM Manual 28: Operating Agreement Accounting for a detailed description of the calculation of allocation charges.

3.1 Overview of the PJM Regulation Market

PJM uses resource schedules, regulation offers, and energy offers from the Markets Gateway System as input data to the ASO to provide the lowest cost alternative for the procurement of Regulation for each hour of the operating day. The lowest cost alternative for this service is achieved through a simultaneous co-optimization with Synchronized Reserves, Non-Synchronized Reserves, [Secondary Reserve](#) and Energy. Within the co-optimization, an RTO dispatch profile is forecasted along with LMPs for the market hour. Using the dispatch profile and forecasted LMPs, an opportunity cost, adjusted by the applicable Performance Score and Benefits Factor, is estimated for each resource that is eligible to provide Regulation. The estimated opportunity cost for Demand Resources is zero. The adjusted lost opportunity cost is added to the adjusted regulation capability cost and the adjusted regulation performance cost to make the adjusted total regulation offer cost. The adjusted total regulation offer cost is then used to create the merit order price. Resource owners may self-schedule Regulation on any qualified resource. The merit order price for any self-scheduled Regulation resource is zero. All available regulating resources are then ranked in ascending order of their merit order prices, and the lowest cost set of resources necessary to simultaneously meet the PJM Regulation Requirement, PJM Synchronized Reserve Requirement, PJM Primary Reserve Requirement, [and PJM 30-Minute Reserve Requirement](#) and provide Energy in that hour is determined. If there is an excess of self-scheduled and zero-cost offers over and beyond the Regulation Requirement, PJM uses resource-specific historic performance scores, selecting those resources with the highest performance scores, as a tie-breaker to determine which set of resources to commit to meet the Regulation Requirement. The least cost set of Regulation resources identified through this process are then committed. Prices for Regulation are calculated simultaneously with Energy and Reserves every five (5) minutes by the Locational Pricing Calculator (LPC) in the pricing run. The highest merit order price associated with this lowest cost set of resources awarded Regulation becomes the RMCP. The RMPCP is calculated as the highest adjusted performance offer from the set of cleared resources. The RMCCP is the difference between RMCP and RMPCP. In the after-the-fact settlement, any resources self-scheduled to provide Regulation are compensated based on the processes described in PJM Manual 28: Operating Agreement Accounting.

3.2.1 Regulation Market Eligibility

Regulation resources that are dual certified as RegA and RegD may submit a set of offers for each signal type. In such case, the Market Clearing Engine evaluates both offers but will clear the resource for either one or neither of the two signal types based on economics and system needs. A dual certified resource offering both signal types in a given hour, if cleared for Regulation, is assigned one signal type for that the entire hour. The signal type assigned may vary from one hour to another during the course of the day if both signal types are made available consistently.

- If a dual certified resource submits self-scheduled regulation offers as both RegA and RegD signal types in the same hour, the Market Clearing Engine only evaluates the RegA self-schedule offer and then either commits the resource or not based on system needs.
- If a resource submits offers into both the Regulation and Reserve Markets in the same hour, the regulation offer receives higher priority in the market clearing process, meaning if economic for both markets, the unit is committed for Regulation rather than Reserves.

3.2.7 Regulation Market Clearing

PJM clears the Regulation Market [taking into account forecast load, transmission constraints and reserve requirements simultaneously with the Energy and Reserve Markets](#), and posts the results no later than thirty (30) minutes prior to the start of the operating hour in the Markets Gateway System.

3.2.7.5 Total Offer

Each MCE, as described in Sections 2.5 and 2.7 of this Manual, ranks all available regulating resources in ascending merit order price, and simultaneously determines the least expensive set of resources necessary to provide Energy, Regulation and Reserves for the operating hour taking into account any resources self-scheduled to provide any of these services. The Rank Price is determined as follows:

Rank Price = Adjusted Total Offer Cost \$ Capability (MW)

Should the MCE be unable to fulfill both the Regulation and Reserves Requirements, Regulation receives the higher priority.

[Section 4: PJM Reserve Markets](#)

[Welcome to the Overview of the PJM Reserve Markets section of the PJM Manual for Energy & Ancillary Services Market Operations. In this section, you will find description of Synchronized Reserve, Primary Reserve, and 30-Minute Reserve Services and the Synchronized Reserve, Non-Synchronized Reserve, and Secondary Reserve Products as applied in both Day-ahead and Real-time Reserve Markets and Operations.](#)

Section 4.1 Overview of the PJM Reserve Market

The PJM Reserve Markets provide PJM participants with a market-based system for the purchase and sale of the Synchronized Reserve, Primary Reserve, and 30-Minute Reserve Services. The PJM Reserve Markets are conducted in both the Day-ahead Market processes and in real-time. In day-ahead, PJM schedules reserves on a simultaneously, co-optimized basis with Energy for each hour of the next Operating Day. In real-time, PJM procures reserves on a simultaneously, co-optimized basis with Energy for each hour and each intervalensures the required reserve levels are maintained.

Both the Day-ahead and Real-time Reserve Markets are offer-based and procure resources to meet the required Reserve Services:

- Synchronized Reserve Service: can only be satisfied by online resources that are able to respond in ten (10) minutes or less.
- Primary Reserve Service: can be satisfied by online or offline resources that are able to respond in ten (10) minutes or less.
- 30-Minute Reserve Service: can be satisfied by online or offline resources that are able to respond in thirty (30) minutes or less.

PJM has three reserve products that can meet the required Reserve Services:

- Synchronized Reserve Product: online resources that are able to respond in ten (10) minutes or less. The Synchronized Reserve product can satisfy the Synchronized Reserve, Primary Reserve, and 30-Minute Reserve Services.
- Non-Synchronized Reserve Product: offline resources that are able to respond in ten (10) minutes or less. The Non-Synchronized Reserve product can satisfy the Primary Reserve and 30-Minute Reserve Services.
- Secondary Reserve Product: online or offline resources that are able to respond between ten (10) and thirty (30) minutes. The Secondary Reserve product can satisfy only the 30-Minute Reserve Service.

The Synchronized Reserve, Non-Synchronized Reserve and Secondary Reserve products have a priority sequence based on the level of reliability which each provides. Synchronized Reserve, being the most reliable as it is online and can respond in ten (10) minutes or less, can also meet the Primary and 30-Minute Reserve requirements. Likewise, Non-Synchronized Reserve can also meet the 30-Minute Reserve requirement. Since the system operates in the most economical manner while satisfying each reserve requirement, economics dictate the extent to which more reliable reserve excesses are applied to subordinate reserve categories.

Day-ahead and Real-time Reserve Products

Manual 11 Reserve Price Formation Revisions – Redline

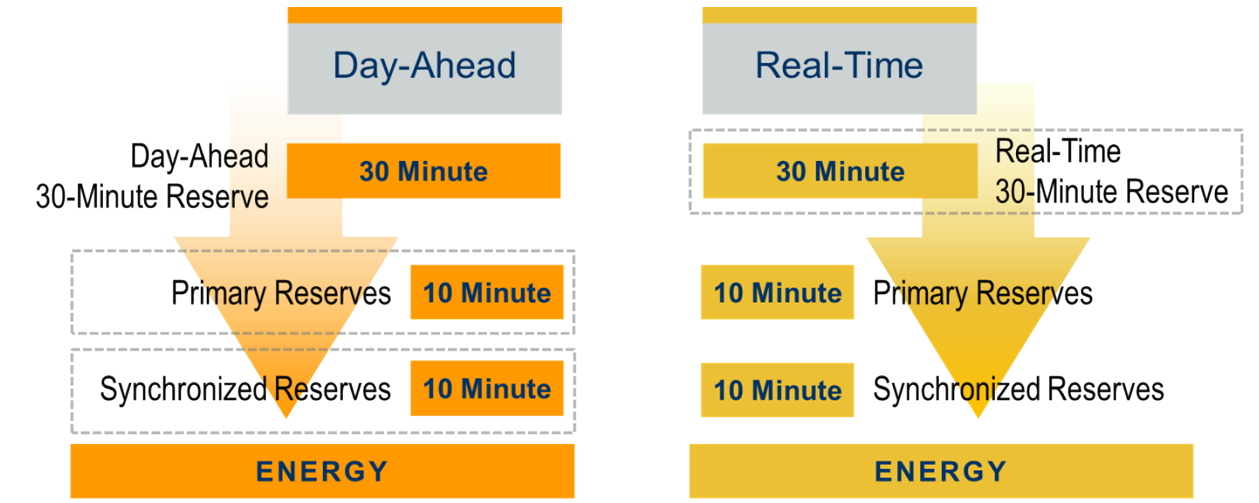

Reserve Services and the Reserve Products that can satisfy the requirements.

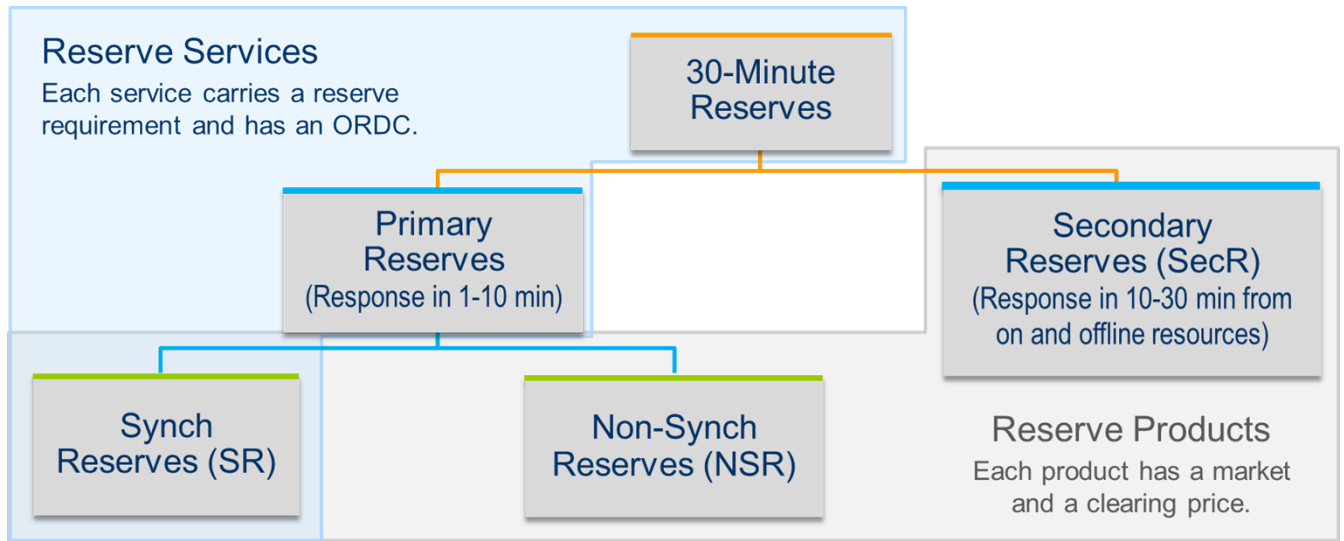

Each Load Serving Entity (LSE) on the PJM system incurs a Reserve Obligation in kWh based on their Real-time load ratio share and the procured supply to meet each Reserve product. For more information on LSE Reserve obligations, refer to section 4.6 of this Manual.

For more information on how PJM monitors and restores reserves, refer to PJM Manual 12: Balancing Operations.

For information on the Reserve Requirements, refer to PJM Manual 13: Emergency Operations.

The following sections apply to both DA and RT, unless specifically stated.

Section 4.2 PJM Reserve Market Offer Business Rules

Section 4.2.1 Reserve Market Resource Eligibility

In general, Generation, Energy Storage Resources, and Economic Load Response resources are eligible to provide Synchronized Reserves, Non-Synchronized Reserves, and Secondary Reserves except if:

- The resource is not within the metered boundaries of PJM
- The entire output is offered as Emergency Only
- The resource type includes: Nuclear, Wind, or Solar, unless an exception is requested and approved
- The resource is not available to provide energy or reduce load

In addition, the following resources are not eligible to provide Non-Synchronized Reserves:

- Economic Load Response
- Energy Storage Resources enrolled in the ESR participation model
- Pumped hydro resources that are not participating in the PJM optimized pumped storage model

Generation resources, including ESRs enrolled in the ESR participation model, must be able to provide 0.1 MW of Reserve Capability in order to participate in the Reserve Markets.

In the event PJM forecasts a credible natural gas pipeline contingency(s), as described in PJM Manual 13: Emergency Operations, Section 3.9, PJM Dispatch will determine the eligibility of resources to provide Reserves depending on the severity of the contingency and other system conditions in order to ensure system reliability is maintained .

Section 4.2.1.1 Requests for Eligibility for Nuclear, Wind, Solar Resources

The Market Seller of a nuclear, wind, or solar resource may obtain approval for the resource to be considered eligible to provide reserves by submitting to the Office of the Interconnection and the Market Monitoring Unit a written request for exemption and provide documentation to support the resource’s ability to follow dispatch at the direction of PJM, such as historical operating data showing voluntary response to reserve events and/or technical information about the physical operation of the resource. Requests and questions may be submitted by Market Sellers to Reserves@pjm.com.

The Office of the Interconnection and the Market Monitoring Unit will review, in an open and transparent manner as between the Market Seller, the Market Monitoring Unit, and the Office of the Interconnection, the information and documentation in support of the request for approval to provide reserves.

Manual 11 Reserve Price Formation Revisions – Redline

PJM will determine, with the advice and input of the Marketing Monitoring Unit, whether the resource will be permitted to provide reserves and provide written notification to the Market Seller of such determination no later than 30 business days from the date of data submittal supporting the request. If the request is denied, PJM will include in the notice a written explanation for the denial.

Section 4.2.1.2 Economic Load Response Reserve Eligibility

- Economic Load Response must successfully complete Ancillary Services certification in PJM DR Hub system for Reserve Market participation.
- Economic Load Response must be able to provide 0.1 MW of Reserve Capability in order to participate in the Reserve Markets.
 - See section 10.5 in this Manual for Economic Load Response aggregation rules to meet the 0.1 MW threshold for locations that have capability less than 0.1 MW.
- Economic Load Response providing reserves are required to provide after-the-fact meter data at a one (1) minute interval for each location called on to respond in a reserve event.
- Residential locations without meters recording at a one (1) minute interval or shorter may participate using the statistical sampling method detailed in PJM Manual 19: Load Forecasting and Analysis, Attachment D and subject to PJM approval.
- After-the-fact one (1) minute meter data for locations called on to respond in a reserve event must be submitted into the PJM DR Hub system no later than two (2) business days following the event day.
- Economic Load Response Curtailment Service Providers not providing complete, accurate and timely meter data for locations called on to respond in a reserve event may be suspended from participating in the Reserve Markets until corrective measures are implemented and may be referred to the PJM Market Monitor and/or the FERC Office of Enforcement for further investigation as necessary.
- Economic Load Response Curtailment Service Providers must complete initial and continuing training on Regulation and Reserve Markets as documented in PJM Manual 40: Certification and Training Requirements, Section 2.6: Training Requirements for Demand Response Resources Supplying Regulation and Reserve.
- Whenever Economic Load Response assigned in the Reserve Markets is called on to respond to a mandatory Emergency or Pre-Emergency Load Management Event, it will be de-assigned from Reserves for any intervals that overlap with the Load Management Event, starting from the notice time of the Load Management Event, unless otherwise approved by PJM. PJM will not assign the resource to Reserves for the remainder of the mandatory portion of the Load Management Event.
- Economic Load Response that demonstrate the ability to receive ~~Tier 2~~reserve commitments via approved telemetry (e.g. Jetstream) qualify as a Flexible resource. Otherwise, Economic Load Response resources are regarded as Inflexible resources.

Section 4.2.2 Reserve Resource Offer Requirements

Manual 11 Reserve Price Formation Revisions – Redline

- Any generator that is a PJM generation capacity resource that has a Reliability Pricing Model (RPM) or Fixed Resource Requirement (FRR) Resource commitment that is eligible to provide Reserves must offer their 10-minute and 30-min reserve capability, unless the unit is unavailable due to an approved planned outage, maintenance outage or forced outage.
 - If a resource that has a reserve must offer requirement chooses to not make its reserve capability available, for example through self-scheduling or offering a fixed output, when the resource is otherwise able to operate with a dispatchable range, the resource is defined to be violating the reserve must offer requirement.
- All other generation resources that are eligible to provide reserves that have submitted Energy offers are considered to have offered the unit's applicable capability into the reserve markets
 - Hydroelectric, Economic Load Response and Energy Storage Resources (ESR) are not considered available by default, and must submit specific reserve offers to be considered.
 - For multiple physical units that are modeled as an aggregated resource in the Market system, if at least one of the physical units are online, then the aggregate is considered online and may be considered for online synchronized and/or online secondary reserves, but not eligible for non-synchronized reserve.

Section 4.2.2.1 Communication for Reserve Capability Limitation

A generation resource owner may request a lesser synchronized reserve maximum or secondary reserve maximum than the economic maximum if a physical limitation exists that cannot be addressed using the multi-segmented hourly ramp rate. Resource owners may submit a request for this modification to Reserves@pjm.com. A copy of this email will be made available to the Market Monitoring Unit. The request should include the Markets Gateway unit name, unit id, and documentation to support the request. PJM will determine, with the advice and input of the Marketing Monitoring Unit, whether the request is approved or denied and provide a written notification to the generation resource owner no later than 30 business days from the date of data submittal supporting the request. If the request is denied, PJM will include in the notice a written explanation for the denial. Further description of the via the communication process for consideration of resource physical limitation which can be found on the PJM website under "Modification to Reserve Market to Better Reflect the Operating Characteristics of Participating Generating Units" at this location: <https://www.pjm.com/-/media/markets-ops/ancillary/communicationprocess-for-consideration-of-resource-physical-limitation.ashx?la=en>

Section 4.2.3 Reserve Market Resource Offer Structure

- All generation resources that have submitted energy offers and are eligible to provide reserves, as defined in Section 4.2.1 above, will be considered as offered into the Reserve markets.
 - This excludes hydropower resources and Energy Storage Resources who must submit specific Reserve offers to be considered.

Reserve offers consist of three elements: availability, offer MW, and offer price and vary depending on the type of resource and the market in which the resource is participating. Resource specific rules are detailed below.

Availability

| Reserve Market | Resource Type | | | | | |
|----------------|--------------------------|-----------|------------------------|--|---------------|-------------|
| | Condensers | Other Gen | Wind/Solar/ Nuclear | ESR/Hydro | Load Response | |
| SR | Set through energy offer | | | Specify availability separately | | |
| NSR | | | | N/A for ESR; Specify availability separately for hydro | | N/A for NSR |
| SecR | | | | Specify availability separately | | |

- Availability for generation not including ESR and hydro resources is set through Energy Offer availability status
- Hydroelectric, ESR, and Economic Load Response resources have the ability to separately specify the availability for Reserves.
- Should a Hydro, ESR, and Economic Load Response resource be unable to participate in the Reserve Market in any given hour on the Operating Day, the following required updates should be made sixty-five (65) minutes prior to the operating hour in the Reserve Market Updates screens of Markets Gateway:
 - Set Offer MW to zero.
 - Set Availability to ‘Not Available’
- Resources are able to self-schedule into the Synchronized Reserve Market only.
 - Eligible ESR, Hydroelectric, and Economic Load Response resources that choose to self-schedule will use their submitted Offer MW quantity as the self-schedule Reserve Offer MW.
 - A resource’s choice to self-schedule or provide fixed output does not alter its capability to provide reserves. Self-scheduled units must provide reserves like all other online generating resources

Offer MW

- PJM will calculate the Reserve MW quantity available from each generation resource, not including ESR and Hydroelectric resources, based on the bid in energy parameters, reserve parameters, Regulation status and current energy output data as described in Section 4.2.5 of this Manual.
- Other resources, may specify offer MW values as described below, where:
 - Synchronized Reserve offer MW is reserve capability of a resource that can be converted fully into energy in ten (10) minutes, or the load reduction achievable in ten (10) minutes and is provided by equipment electrically synchronized to the system.
 - Non-Synchronized Reserve offer MW is reserve capability of a resource that can be fully converted into energy within ten (10) minutes and is provided by equipment not electrically synchronized to the system.
 - Secondary Reserve offer MW is reserve capability of a resource that can be converted fully into energy after ten (10) minutes and before thirty (30) minutes, or the load reduction achievable after ten (10) minutes and before thirty (30) minutes by equipment which may not necessarily at the time of the request be electrically synchronized to the system.

The ability to specify an Offer MW varies by resource type, as described below:

| Parameter | Reserve Market | Resource Type | | | | |
|-----------------|----------------|---------------------------------|-----------|--------------------|---------------|---------------|
| | | Condensers | Other Gen | Wind/Solar/Nuclear | ESR/Hydro | Load Response |
| Offer MW | SR* | Via PJM calculate capability MW | | | Yes | Yes |
| | NSR | | | | Yes (N/A ESR) | N/A |
| | SecR* | | | | Yes | Yes |

*Resources able to specify separate Offer MW can update in real-time up to 65 minutes prior to start of operating hour

- The Offer MW for generation resources not including ESR and hydro resources is calculated for all applicable intervals by PJM as described in Section 4.2.5
- Hydroelectric resources can must separately specify an Offer MW for Synchronized, Non-Synchronized, and Secondary Reserves
- ESR and Economic Load Response resources can must separately specify an Offer MW for Synchronized and Secondary Reserves. Note: ESR and Economic Load Response resources are not eligible to provide Non-Synchronized Reserves.

Manual 11 Reserve Price Formation Revisions – Redline

- [Offer quantities specified on the Synchronized Reserve Offer, Non-Synchronized Reserve Offer, and Secondary Reserve Offer pages in Markets Gateway for Hydroelectric, ESR, or Economic Load Response resources that are also capacity resources are automatically carried over from one day to the next.](#)
- [Changes made on the Synchronized Reserve Updates, Non-Synchronized Reserve Updates, and Secondary Reserve Updates pages of Markets Gateway are not carried over into the next market day. Any changes made to the Synchronized Updates, Non-Synchronized Reserve Updates, and Secondary Reserve Updates pages supersedes the values on the Offer pages.](#)
- [Resources permitted to specify an Offer MW may specify hourly values, and update up to 65 minutes prior to the start of the operating hour as specified in Section 9.1 Hourly offer MW for reserves must remain up to date and accurate for capacity resources to comply with the reserve must offer requirement.](#)

Offer Price

| Parameter | Reserve Market | Resource Type | | | | |
|-------------|----------------|--|-----------|------------------------|-----------|---------------|
| | | Condensers | Other Gen | Wind/Solar/ Nuclear | ESR/Hydro | Load Response |
| Offer Price | SR | Yes, cannot exceed expected value of penalty | | | | |
| | NSR | N/A | | | | |
| | SecR | N/A | | | | |

- [All resources may specify a Synchronized Offer Price \(\\$/MWh\)](#)
 - [Synchronized Reserve offer prices must be cost-based and are capped at the Expected Value of Synchronized Reserve Penalty.](#)
 - [The Offer Price cannot be a negative value](#)
 - [All resources listed as available for Synchronized Reserves with no Offer Price have their Offer Prices set to \\$0.00/MWh.](#)
- [The Expected value of Synchronized Reserve Penalty = Average Penalty Rate \(\\$/MWh\)*Probability of an event*Probability of underperformance, as specified in Manual 15.](#)
- [Offer prices for Non-Synchronized Reserve and Secondary Reserve are \\$0.00/MWh and are not able to be submitted in Markets Gateway](#)
- [Shutdown Cost \(\\$/MWh\): This is the cost Economic Load Response incurs when reducing load in response to a reserve event and must be approved by PJM and the IMM if a non-zero value is requested zero.](#)

Section 4.2.4 Offer Period Timing

- Day-ahead Reserve Market Offers for eligible generators or Economic Load Response resources must be supplied prior to 1100 day-ahead
- Real-time Reserve Market Offers must be supplied prior to 1415 day-ahead except when specifying hourly updates.
 - Parameters that may be updated hourly up to sixty five (65) minutes prior to the start of the operating hour include:
 - Offer MW (if eligible)
 - Availability (if eligible)
 - Synchronized Reserve Offer Price (\$/MWh) (if opted in to Intraday Updates as detailed in Section 9.1.1)
 - Synchronized Reserve Self-schedule status
 - Parameters that may be updated within the operating hour include:
 - Synchronized Reserve Maximum MW, if eligible
 - Secondary Reserve Maximum MW, if eligible
- Any hourly updates supersede the values on the daily Offers page.
- The Real-Time Market Clearing Engines will use the offered in parameters as detailed in Sections 2.5 and 2.7 of this Manual.

Section 4.2.5 Reserve Market Resource Capability

PJM will calculate the Synchronized Reserve, Non-Synchronized Reserve, and Secondary Reserve capability available from generation resources that are not able to specify an Offer MW.

Section 4.2.5.1 Reserve Market Capability for Online Generation Resources

PJM will calculate the Synchronized Reserve (SR) and Secondary Reserve (SecR) MW quantity available for online resources that are ineligible to submit an Offer MW, based on the following offer parameters submitted as part of the resource's energy offer:

- Initial energy output
- Ramp rate
- Economic Minimum
- the lesser of Economic Maximum and Synchronized Reserve maximum MW or Secondary Reserve maximum MW, where Synchronized Reserve maximum MW or Secondary Reserve maximum MW may be lower than the Economic Maximum only where the Market Seller has been approved to submit a lower value as described in Section 4.2.2.1 of this Manual

Manual 11 Reserve Price Formation Revisions – Redline

SR MW Capability = max {0, min [min(EcoMax, Synch Max) – Initial Energy Output, RampRate* 10 minutes]}

SecR MW Capability = max {0, min [min(EcoMax, SecR Max) – Initial Energy Output, RampRate* 30 minutes] – SR MW}

Section 4.2.5.2 Reserve Market Capability for Offline Generation Resources

PJM will calculate the Non-Synchronized (NSR) and Secondary Reserve (SecR) MW quantity available for offline resources that are ineligible to submit an Offer MW, based on the following offer parameters submitted as part of the resource’s energy offer

- startup and notification times
- ramp rate
- Economic Minimum
- the lesser of Economic Maximum and Secondary Reserve Maximum MW, where Secondary Reserve maximum MW may be lower than the Economic Maximum only if the Market Seller has been approved to submit a lower value as described in Section 4.2.2.1 of this Manual

NSR MW Capability = max {0, min [EcoMax, EcoMin + (10 – Startup – NotificationTime) *RampRate]}

SecR MW = max {0, min [min (EcoMax, SecRMax), EcoMin + (30 – Startup – NotificationTime) *RampRate] – NSR MW}

Section 4.2.5.3 Reserve Market Capability for Synchronous Condensers

PJM will calculate the Synchronized Reserve and Secondary Reserve MW quantity available for resources capable of synchronous condensing based on the following offer parameters submitted as part of the resource’s energy offer:

- ramp rate
- condense to generation time constraints
- Economic Minimum
- the lesser of Economic Maximum and Synchronized Reserve maximum MW or Secondary Reserve maximum MW, where Synchronized Reserve maximum MW or Secondary Reserve maximum MW may be lower than the Economic Maximum only if the Market Seller has, in accordance with the procedures set forth in the PJM Manuals, submitted justification to the Office of the Interconnection that the resource has an operating configuration that prevents it from reliably providing Synchronized Reserves above the Synchronized Reserve maximum MW

Manual 11 Reserve Price Formation Revisions – Redline

SR MW Capability = max {0, min [min (EcoMax, SynchMax), EcoMin + RampRate* (10 minutes-condense to gen time)]}

SecRMW Capability = max {0, min [min (EcoMax, SecR Max), EcoMin + RampRate* (30 minutes – Condense to gen time)] – SR MW}

Energy Usage for reserve condensing resources (MW): This is the amount of instantaneous energy a condensing resource consumes while operating in the condensing mode. The value submitted as part of the Reserve offer must be less than or equal to the actual energy consumed as observed in real time.

- Condense to gen cost: This is the cost of transitioning a condenser to generating mode. The value submitted for this cost must be less than or equal to the condensing Startup Cost.
- Condense Startup Cost: This is the actual cost associated with getting a resource from a completely off-line state into the condensing mode including fuel, O&M, etc.
- Condense Hourly Cost: This is the hourly cost to condense and is equal to the actual, variable O&M costs associated with operating a resource in the condensing mode, including any fuel costs. It does not include any estimate for energy consumed
- Condense Notification Time: The amount of advance notice, in hours, required to notify the operating company to prepare the resource to operate in synchronous condensing mode. The default value is zero hours.
- Reserve as Condenser: This is used to identify if a resource can be committed from offline state for Synchronized Reserve or Secondary Reserve as a condenser.
- Condense Available Status: This indicates a resource’s availability to provide voltage and/or reactive support. This value is not directly related to the Synchronized Reserve or Secondary Reserve Markets.

Section 4.3 Reserve Requirement Determination

- PJM models a reserve requirement at the RTO and sub-zonal level in whole MW for each hour of the operating day based on the greatest MW loss of all potential Largest Single Contingencies on the system.

| | Reserve Service | | |
|-------------------------|---|---|--|
| | Synchronized Reserve (SR) | Primary Reserve (PR) | 30-Minute Reserve (30-Min) |
| Reliability Requirement | Largest Single Contingency | 150% of Synchronized Reserve Reliability Requirement | Greater of (Primary Reserve Reliability Requirement, 3000 MW, or largest active gas contingency) |
| Reserve Requirement | SR Reliability Requirement + Extended Reserve Requirement | PR Reliability Requirement + Extended Reserve Requirement | 30-Min Reliability Requirement + Extended Reserve Requirement |

- [The Largest Single Contingency in Day-ahead is normally the largest Economic Maximum value for all available schedules or the summation of the largest Economic Maximum value for all available schedules of an active reserve group for the hour.](#)
- [The Largest Single Contingency in Real-time is normally the higher of \[max of \(the largest online generator’s output or Economic Maximum\) or the sum of the higher of \(Economic Maximum values or outputs of an active reserve group\)\].](#)
- [An active reserve group is a model of a station with multiple generation resources with a total capacity in excess of 800 MW, where there is a single outlet or where a single fault would trip multiple generation resources at the station.](#)
- [For purposes of the 30-Minute Reserve Requirement, the largest gas contingency is calculated as the summation of the Economic Maximum values of the identified resources](#)
- [Only those potential Largest Single Contingencies communicated by PJM Operations and modeled in the market clearing software will be eligible to set the applicable reserve requirements used in the market clearing process.](#)
- [There are, at times, outage conditions at stations whereby a single fault would trip multiple generators resulting in a loss of generation greater than the Largest Single Contingency. In such instances, PJM will carry an increased Reserve Requirement in equivalent summation of output of those multiple generators in accordance with Reserve Requirements described in PJM Manual 13: Emergency Operations, Section 2.2.](#)
- [At times, anticipated heavy load conditions may result in PJM operators carrying additional reserves to cover increased levels of operational uncertainty. PJM may extend the 30-Minute Reserve, Primary Reserve and Synchronized Reserve Requirements in the Market Clearing Engine during the on-peak period in order to incorporate these actions in](#)

Manual 11 Reserve Price Formation Revisions – Redline

Energy and Reserve Pricing when a Hot Weather Alert, Cold Weather Alert or an escalating emergency procedure (as defined in PJM Manual 13: Emergency Operations) has been issued for the Operating Day. The extended Synchronized Reserve Requirement, extended Primary Reserve Requirement and extended 30-Minute Reserve Requirement will be equal to the existing extended applicable Reserve Requirement plus the sum of any additional MW brought online for that hour by PJM dispatch to account for operational uncertainty.

- If reserve deliverability issues are anticipated, then the requirements for the active Sub-Zone(s) in which the additional resources are located may be extended. For example, if additional resources are specifically scheduled in the active Sub-zone in anticipation of transmission constraints inhibiting the delivery of reserves into that region, both the active Sub-zone and RTO Reserve Zone requirements would be extended.
- If the additional resources are scheduled in the RTO Reserve Zone, then only the RTO Reserve Zone requirement would be extended.
- The requirements will return to their original values upon exit from emergency procedures or when the additional resources have been released by PJM dispatch.
- PJM will notify market participants of changes to the Reserve Requirements in relation to emergency procedures via the Emergency Procedure Posting Application once the decision to change the Reserve Requirements is made.
- Regardless of the Reserve Requirements modeled in the Market Clearing Engine, PJM operators will continue to initiate emergency procedures based on the Reserve Requirements defined in PJM Manual 13: Emergency Operations.
- Each Reserve Requirement will have an associated reserve demand curve as specified in Section 4.2.6.3 of this Manual

Section 4.3.1 Locational Aspect of Reserves

Due to transmission security considerations on the PJM system, it is necessary to carry a minimum amount of Synchronized Reserve, Primary Reserve, and 30-Minute Reserve in a specific sub-zone in PJM such that loading 100% reserve will not result in an overload of any of the PJM transfer interfaces. The main goal of procuring locational reserves is to not overload critical transmission constraints when reserves are deployed.

- While PJM can model multiple subzones, only one will be active at any given time.
- 30-minute Reserves will not model a sub-zone by default. In the event one is modeled, it will be communicated to participants via Markets Gateway.
- Active subzones will be communicated to the Market Participants via Markets Gateway.

Analysis to determine the lists of generation and load buses with respect to the defined reserve subzones is performed at least once with each quarterly network model update. The current sub-zone list resulting from this analysis can be found in pjm.com at this link: <https://www.pjm.com/markets-and-operations/ancillary-services>.

Section 4.3.2 Creation of New Reserve Subzones

As system conditions dictate, PJM may need to model new sub-zones into the Reserve Markets to better support reliable operations that and produces market results that are more consistent with system operating conditions. New reserve sub-zones may be defined for constraints in three categories:

- Reactive transfer interfaces (AP South, BED-BLA, etc.)
- 230kV or above actual overload constraint (i.e. Conastone-Peach Bottom 500kV actual overload)
- Contingency overload exceeding the load dump limit on a 230kV or above facility

New reserve sub-zones will be defined as far in advance as possible, but will not be created on a same-day basis. Sub-zones will be modeled each day on a day-ahead basis. Changes to the reserve sub-zone in use can be made after the close of the day-ahead market (including intraday) on an exception basis. Stakeholders will be notified of all switches in the modeled reserve sub-zone via Markets Gateway as soon as possible. Only one sub-zone will be active at any given time and will be communicated in the Markets Gateway application. Reserve sub-zone definitions will be published quarterly coincides with the network model builds.

Section 4.3.3 Reserve Demand Curves and Penalty Factors

- Embedded within the Day-ahead and Real-time Market Clearing Engines are Reserve Demand Curves for each Reserve service in each Reserve Zone and Sub-Zone. These demand curves are used to articulate the value of maintaining reserves at specified levels and ensure product substitution between energy and reserves up to the specified penalty factors. They are defined with \$/MWh penalty factors on the Y axis and desired reserve MW on the X axis. The penalty factor represents the price at which reserves will be valued if the desired reserve MW cannot be met with the available reserves on the system, and also acts as a price cap beyond which reserves will not be procured through market clearing
- For example, assume the penalty factor to maintain 1,000 MW of Synchronized Reserves is \$850/MWh. If there are less than 1,000 MW of reserves available, the deficient MW will be valued at \$850/MWh. Similarly, if there are sufficient reserves to meet the 1,000 MW requirement, yet they are not available at a prices less than or equal to \$850/MWh, resources with merit order prices that exceed \$850/MWh will not be cleared and the deficient MW will be valued at \$850/MWh. However, such resources can still be committed manually by PJM operations personnel in order to maintain reliability. In this case, such resources will be compensated additionally after the fact to ensure their true cost to provide the service is covered.
- The penalty factor also provides a clear indicator of the reserve position of the RTO and modeled Reserve Sub-Zones. As the price of a reserve product increases to a value near the penalty factor, it indicates to market participants that the system is nearing a reserve shortage. Separate demand curves exist for each of the following reserve product / Reserve Zone or Sub-zone combinations.
 - RTO Synchronized Reserve

Manual 11 Reserve Price Formation Revisions – Redline

- [Active Sub-Zone Synchronized Reserve](#)
- [RTO Primary Reserve](#)
- [Active Sub-Zone Primary Reserve](#)
- [RTO 30-Minute Reserves](#)
- [Active Sub-zone 30-Minute Reserves \(if applicable\)](#)
- [The demand curves for each of these products and locations are similar in that they share the same penalty factors on the Y axis; however, the desired reserve levels on the X axis differ to reflect the Reserve Requirement differences amongst the reserve products and locations. These demand curves are defined as follows:](#)
 - [Step 1:](#)
 - [Penalty Factor = \\$850/MWh](#)
 - [Desired Reserve MW = locational Reliability Requirement for the specified reserve product as defined in Section 4.3 above.](#)
 - [Step 2:](#)
 - [Penalty Factor = \\$300/MWh](#)
 - [Desired Reserve MW = locational Reliability Requirement for the specified reserve product as defined in Section 4.3 above plus 190 MW plus any additional reserves that are being carried in anticipation of heavy load conditions, as referenced in Section 4.3 above.](#)

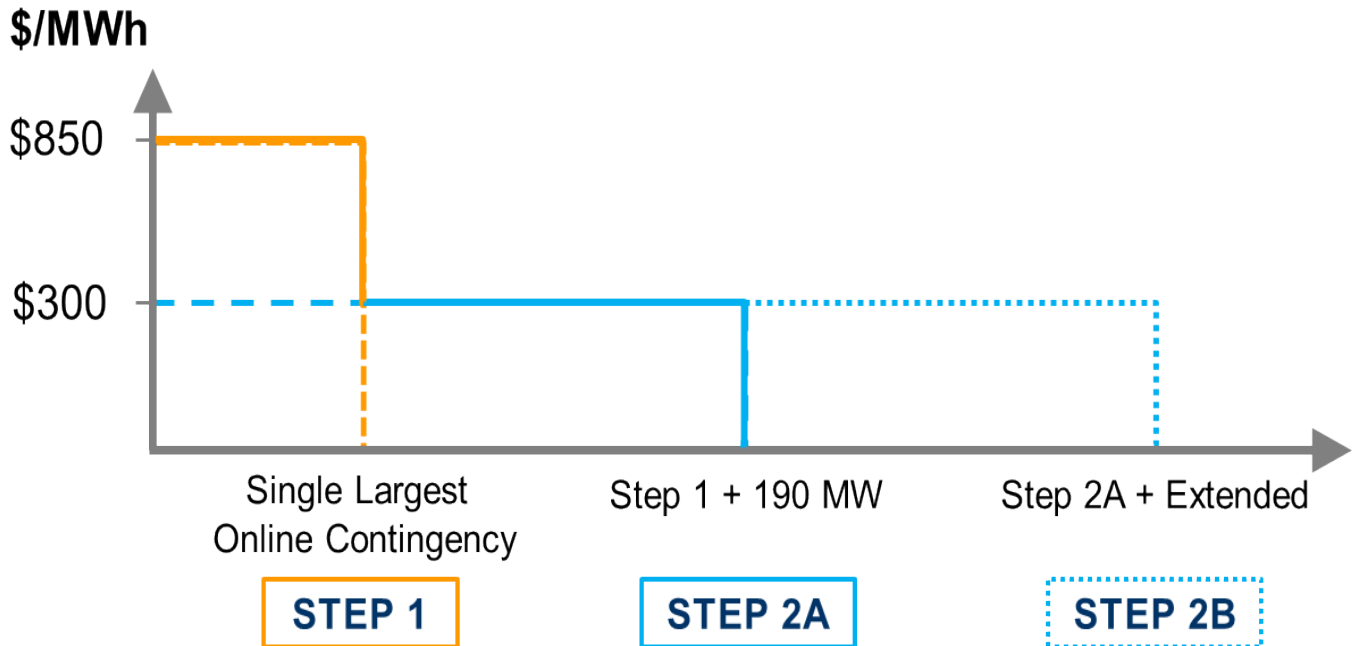

- [In the Day-ahead Market, due to the Reserve Requirements being based on largest Economic Maximum value, as described in section 4.3, the MW values may change hourly.](#)
- [In the Real-time Market, due to the Reserve Requirements being based on the Real-time Largest Single Contingency, the MW values on the X axis of the demand curves used in market clearing can change dynamically with each Real-time market clearing case execution. Below is an example of what the demand curve for Synchronized Reserves would look like if the output of the Largest Single Contingency was 1,210 MW for that](#)

[specific case execution.](#)

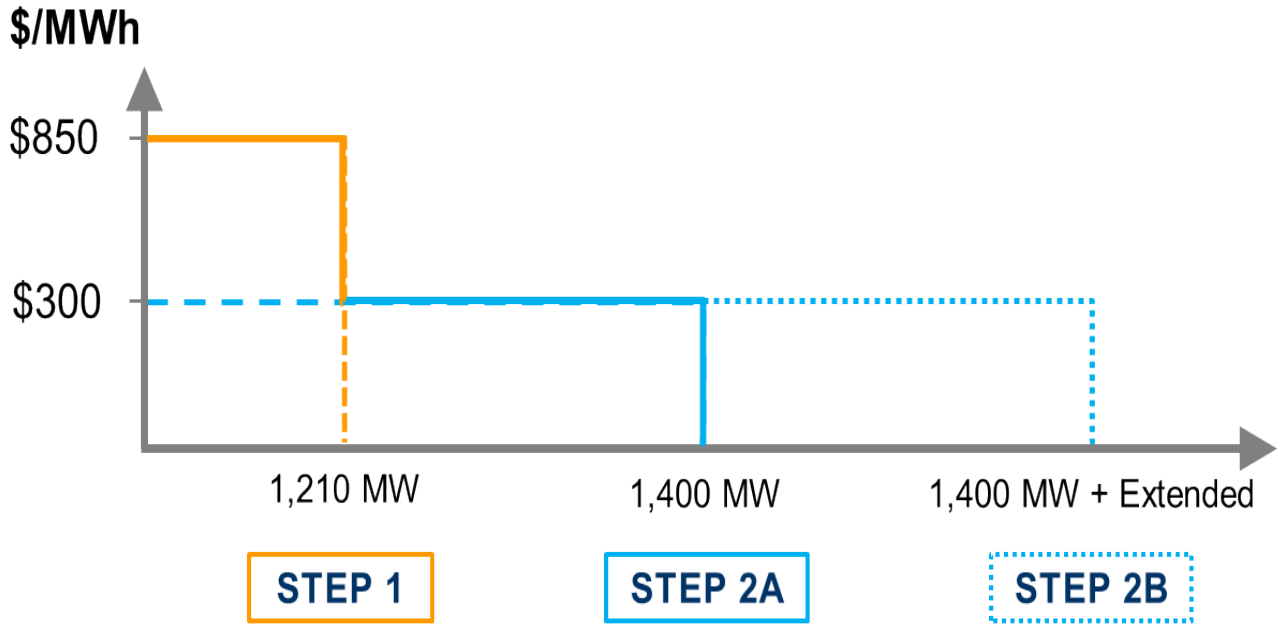

[Section 4.4 Reserve Market Clearing](#)

[PJM schedules resources as needed to meet the Reserve Requirements of each Reserve Zone and active subzone via joint optimization with energy in both the day-ahead and real-time markets. Resources are scheduled based on the resource-specific offer data submitted as defined in Section 4.2 of this Manual and the product substitution cost of providing energy or any other product the resource is capable of providing. The joint optimization seeks to procure and minimize the total production cost of energy and meeting the various reserve requirements as described in Section 4.3 of this Manual, and in the Real-time Market, the Regulation Requirement as described in Section 3.2.4 of this Manual.](#)

[Reserves and energy will be co-optimized the same way in the Day-ahead and Real-time Market.](#)

- [The same reserve zone configuration will be modeled in day-ahead and real-time unless there is an operational emergency requiring it to be changed in real-time](#)

[Section 4.4.1 Product and Locational Substitution](#)

Manual 11 Reserve Price Formation Revisions – Redline

As described in Section 4.1, the Synchronized Reserve, Non-Synchronized Reserve and Secondary Reserve products have a priority sequence based on the level of reliability which each provides. Synchronized Reserve, being the most reliable as it is online and can respond in ten (10) minutes or less, can also meet the Primary and 30-Minute Reserve requirements. Likewise, Non-Synchronized Reserve can also meet the 30-Minute Reserve requirement.

In addition, the location of the reserves procured also have a hierarchy. Reserves procured in a subzone can also meet the requirement of the RTO.

As a result, a megawatt cleared in a subzone for Synchronized Reserves can also be used to meet the RTO Synchronized Reserve Requirement, the subzone Primary Reserve Requirement, the RTO Primary Reserve Requirement, the subzone 30-minute Reserve Requirement (if modeled), and the RTO 30-minute Reserve Requirement.

PJM will commit the most economic combination of resources to simultaneously meet all energy and reserve requirements.

The graphic below illustrates the product and locational substitution.

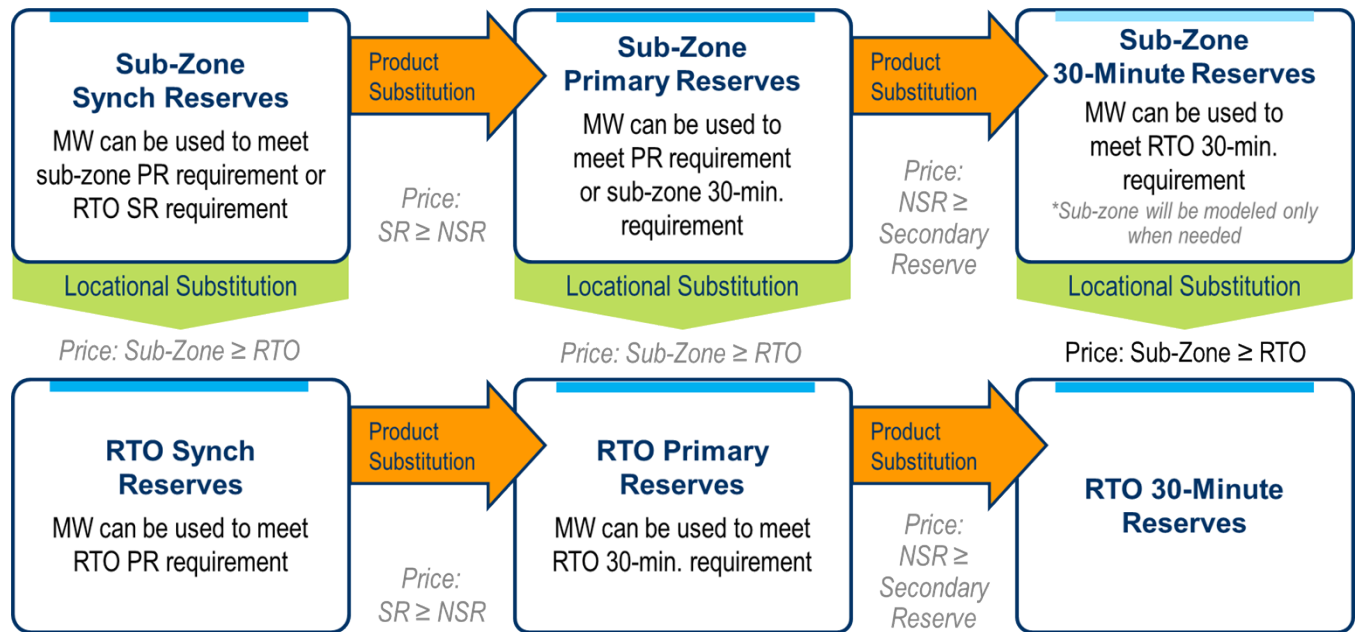

Section 4.4.2 Day-ahead Reserve Market Clearing

The Day-ahead Reserve Market clearing results in an hourly price for Synchronized Reserves, Non-Synchronized Reserves, and Secondary Reserves for the next day, and is posted along with the resource-specific reserve assignments from the dispatch run by 1330 EPT via the PJM Markets Gateway System.

Manual 11 Reserve Price Formation Revisions – Redline

The hourly Reserve Clearing Prices are fixed once calculated and posted by 1330 EPT the day before the Operating Day. The hourly Reserve clearing prices are based upon the offer prices submitted by the selected resources, together with any opportunity cost a resource incurs in the Day-ahead joint-optimization process, from the pricing run, in order to meet the Reserve Requirements.

The hourly Day-ahead Market Reserve clearing prices are set equal to the merit order price of the highest cost Reserve Resource necessary to meet the remaining requirement in the pricing run and may include Amortized Start-Up and/or Amortized No-Load costs for eligible Fast-Start Resources as part of the integer relaxation method.

- For the purpose of determining the most economic set of resources with which to meet the Reserve Requirements, PJM will calculate a resource-specific merit order price for each resource using the following methodology:
 - Resource merit order price (\$/MWh) = Resource Synchronized Reserve Offer + ~~estimated~~ resource opportunity cost per MWh of capability + ~~condense~~ energy use per MWh of capability + condense startup cost
 - **Note:** Condense startup cost is not included in the determination of the clearing price.

Section 4.4.3 Real-Time Reserve Market Clearing

Sixty (60) minutes prior to the operating hour PJM executes the Ancillary Services Optimizer (ASO). The ASO jointly optimizes Energy, Synchronized Reserves, Non-Synchronized Reserves, Secondary Reserves, and Regulation based on forecast system conditions to determine an economic set of inflexible reserve resources to commit for the operating hour. Inflexible resources are defined as those resources that physically require an hourly commitment due to minimum run time constraints or staffing constraints. Inflexible resources include but are not limited to synchronous condensers that are operating in condensing mode solely for the purpose of providing Synchronized Reserves and Economic Load Response that are prepared to curtail in response to a PJM Reserve Event.

Any inflexible self-scheduled offers for Synchronized Reserves that are available at the time of the ASO execution are assumed valid and committed for the hour.

Any reserve commitments on inflexible resources that are made are locked for the operating hour and communicated via Markets Gateway.

- Condensers and Inflexible Economic Load Response resources that are cleared day-ahead will have their commitments carried to real-time
 - These resources need to have a min run time (min down time for ELR) no greater than one hour and notification time between ten and thirty minutes.
 - The reserve commitment is carried over unless in real-time the resource is committed to provide energy or another ~~reserve-ancillary~~ product

Manual 11 Reserve Price Formation Revisions – Redline

The following reserve information will be posted to Markets Gateway thirty (30) minutes prior to the operating hour from the approved ASO case:

- Preliminary Reserve Requirements for the RTO and active Sub-Zone.
- Total projected Reserve MW transferrable from the RTO into the active Sub-Zone.
- Total preliminary assigned reserve MWs for the RTO and active Sub-Zone.
- Total preliminary self-scheduled Reserves for the RTO and active Sub-Zone.
- Forecasted reserve deficit MW quantities for the RTO and active Sub-Zone.

The following resource specific reserve information will be posted to Markets Gateway thirty (30) minutes prior to the operating hour from the approved ASO case:

- Reserve Offer MW for the applicable product
- Inflexible Reserve Awarded MW for the applicable product
- Inflexible Synchronized Reserve Self-scheduled MW

Additional Real-time Reserve commitments may be made on flexible reserve resources by the RT SCED application and additional inflexible reserves resources recommendations by the IT SCED application. Commitments on flexible reserves resources may change with each execution of the RT SCED application while commitments on inflexible reserve resources will respect the minimum run time of those resources. PJM Operator, if necessary, may manually request an inflexible resource previously committed for reserves to provide energy. Such reasons include but are not limited to constraint control. Such action will automatically terminate the resource's reserve assignment.

- Flexible reserve resource commitments will not be posted to Markets Gateway but will be telemetered via ICCP or other communication protocol to resource owners.
- Additional inflexible resource commitments will be communicated to the resource owners via ICCP or other communication protocol.

PJM utilizes resource specific offers together with energy offers and resource schedules from the Markets Gateway System, as input data to the Ancillary Service Optimizer (ASO). ASO then optimizes the RTO dispatch profile and forecasts LMPs to determine hourly commitments for inflexible resources.

Although the ASO considers all available resources during its commitment process, the hourly commitments for Reserves from the ASO are limited to inflexible resources only and may only represent a portion of PJM's Reserve needs for the hour.

IT SCED has the ability to project conditions further out into the future and make a recommendation to commit additional inflexible resources for reserves where they are economic.

The Real-time Security Constrained Economic Dispatch (RT SCED) program jointly optimizes the remaining RTO Reserve needs simultaneously with Energy while honoring effective regulation assignments. For more information on how RT SCED uses Reserve commitments in

Manual 11 Reserve Price Formation Revisions – Redline

the joint optimization, please refer to Section 2.5 of this Manual. The Locational Pricing Calculator (LPC) calculates a clearing price for Reserve every five (5) minutes as described in Section 2.7 of this Manual. Five (5) minute, Real-time, Synchronized Reserve Market Clearing Prices (SRMCP), Non-Synchronized Reserve Market Clearing Prices (NSRMCP), and Secondary Reserve Market Clearing Prices (SecRMCP) are used for market settlement.

During each execution of RT SCED, additional Reserve MWs ~~are~~ **may be** committed to meet the Reserve Requirements from flexible resources for all services based on forecasted system conditions by re-dispatching online generating resources. In addition, RT SCED will commit offline resources to meet the balance of the Primary Reserve Requirement and 30-minute Reserve Requirement.

PJM may call on resources not otherwise scheduled to run in order to provide Reserves, in accordance with PJM's obligation to maintain reliability. If a resource is called on by PJM for the purpose of providing Reserves, the resource is guaranteed recovery of applicable Reserve lost opportunity costs as well as start up, no-load and energy costs. Please refer to PJM Manual 28: Operating Agreement Accounting for additional settlements details.

The Real-time Market Reserve clearing prices are set equal to the merit order price of the highest cost Reserve Resource necessary to meet the remaining requirement in the pricing run and may include Amortized Start-Up and/or Amortized No-Load costs for eligible Fast-Start Resources as part of the integer relaxation method.

Resources cannot clear the Real-time Reserve and Regulation Markets for the same interval. **The requirement for regulation is first met before reserves because regulation is a higher priority service.**

- For the purpose of determining the most economic set of resources with which to meet the Reserve Requirements, PJM will calculate a resource-specific merit order price for each resource using the following methodology:
 - Resource merit order price (\$/MWh) = Resource Synchronized Reserve Offer + estimated resource opportunity cost per MWh of capability + energy use per MWh of capability + condense startup cost
 - **Note:** Condense startup cost is not included in the determination of the clearing price. The opportunity cost for Economic Load Response is zero.

Section 4.4.3.1 Deselection of Reserve Resources in Real-Time

To accurately account for reserves, PJM may temporarily deselect a resource from being eligible for reserves and if necessary deassign a current reserve commitment in certain market intervals for reasons that include but are not limited to the following:

- Resource is not following its dispatch signal
- Resource owner has indicated via telemetry or phone call to PJM Dispatch that a resource is not available due to a physical limitation of the unit or at the plant
 - Resource owner must submit a request for qualification to communicate reserve unavailability via telemetry by emailing Reserves@pjm.com. A copy of this email

will be made available to the Market Monitoring Unit. The request should include the Markets Gateway unit name, unit id, and technical information about the operational modes, limits, or conditions to support the request. PJM will determine, with the advice and input of the Marketing Monitoring Unit, whether the request is approved or denied and provide a written notification to the generation resource owner no later than 60 business days from the date of data submittal supporting the request. If the request is denied, PJM will include in the notice a written explanation for the denial.

Section 4.4.4 Opportunity Costs for Condensers

Estimated resource opportunity cost for condensing CTs is calculated, based on the dispatch run, as follows:

$$O.C. = \text{positive (forecast LMP - energy offer price)} \times \text{MW capability} / \text{synchronized reserve capability}$$

Estimated resource opportunity cost for non-condensing resources is calculated, based on the dispatch run, as follows:

$$O.C. = | \text{LMP} - \text{ED} | \times \text{GENOFF}$$

Where:

| | |
|---------------|---|
| LMP | is the forecasted hourly LMP at the generator bus, |
| ED | is the price associated with the set point the resource must maintain to provide its assigned amount of Synchronized Reserve, and |
| GENOFF | is the MW amount of Synchronized Reserve provided. |

This formula is somewhat simplistic. The actual calculation is an integration that may be visualized as the area on a graph enclosed by the resource's price-energy offer curve. The points on that curve correspond to the resource's desired economic dispatch and the set point necessary to provide the assigned amount of Reserve and the LMP.

Energy use for each condensing resource is entered in MW by the owner via the Markets Gateway system as part of the Reserve Offer. Estimated energy use is calculated as part of the merit order price as follows:

$$E.U. = \text{forecast LMP} \times \text{energy use MW} / \text{synchronized reserve capability}$$

For each of these calculations, forecast LMP is the result of the 1-hour look-ahead calculated in the ASO. Energy resources for which an energy offer is not submitted will be ineligible for opportunity cost credit.

When calculating the reserve MCP in Real-time, the actual LMP is used instead of the forecast LMP in the previous equations and calculated in the LPC engine. The actual five minute reserve MCP, calculated using the LPC pricing run, is used for settlements.

Hydropower units condensing to provide Reserves during times when they were not scheduled to operate incur no opportunity cost. There may or may not be an energy use component, as indicated by the owner as part of the Reserve Offer. Only hydropower units not enrolled in the ESR participation model are considered in the rules below.

- If a hydropower unit is held to condense for reserves or reduced to provide reserves during a time when it is scheduled to generate, it will incur opportunity cost. Since hydropower units operate on a schedule and do not have an energy bid, opportunity cost for these units is calculated as follows:
 - The formula is the same as that shown under ‘Reserve Commitment’, $O.C. = |LMP - ED| \times GENOFF$, except the ED value is the average value of the LMP at the hydropower unit bus for the appropriate on-peak (0700 – 2259) or off-peak (0000 – 0659, 2300 - 2359) period, excluding those hours during which all available units at the hydropower plant were operating. Day-ahead values are used for the purposes of committing reserve resources, and actual LMPs are used in the after-the-fact settlement. If the average LMP value is higher than the actual LMP at the generator bus, the opportunity cost is zero.
- During those hours when a hydropower unit is in spilling mode, the ED value is set to zero such that the opportunity cost is based on the full value of LMP. During the operating day, the operating company is responsible for communicating this condition on the Regulation Hourly Updates page in the Markets Gateway System.
- When determined to be economically beneficial, PJM maintains the authority to adjust hydropower unit schedules for those units scheduled by the owner if the owner has also submitted a Synchronized Reserve Offer for those units and made the units available for spin.
- An example of the reserve lost opportunity cost calculation is very similar to that of the regulation hydropower lost opportunity cost calculation detailed on the PJM website at <https://pjm.com/-/media/markets-ops/ancillary/regulation-uplift-andlost-opportunity-cost.ashx?la=en>.

Section 4.4.5 Determination of Reserve Clearing Prices

PJM clears the Reserve markets based on the locational Reserve Requirements and calculates clearing prices for the RTO and active subzone where applicable. Whenever the locational reserve constraint is not binding, the clearing prices are equal for each category of the reserve products. However, when more Reserves are required in a given location than would have been assigned without this requirement, the clearing prices will separate. Resources will be identified and receive the applicable clearing price based on their location with respect to the binding constraint(s). That is, resources for which reserve event response would help the constraint will receive the higher clearing price, whereas resources for which reserve event response would aggravate the constraint will receive the lower clearing price.

Day-ahead prices for Synchronized Reserves, Non-Synchronized Reserves, and Secondary Reserves are calculated simultaneously with Energy every hour, in the pricing run of the Day-ahead joint-optimization process.

Manual 11 Reserve Price Formation Revisions – Redline

Real-Time prices for Synchronized Reserves, Non-Synchronized Reserves, and Secondary Reserves are calculated simultaneously with Energy, and Regulation, every five (5) minutes by LPC, in the pricing run, as described in Section 2.7 of this Manual.

The prices for Synchronized Reserves, Non-Synchronized Reserves, and Secondary Reserves will be calculated as the marginal cost to serve an additional MW of applicable reserve product in the RTO Reserve Zone and applicable active Reserve Sub-Zone while simultaneously satisfying energy requirements, regulation requirements, synchronized reserve requirement, primary reserve requirements, 30-minute reserve requirements, and transmission limitations.

The hourly Day-ahead Reserve clearing prices from the pricing run are fixed once calculated and posted in Markets Gateway and Data Miner with the Day-ahead results by 1330 EPT the day before the Operating Day.

Preliminary Real-time five (5) minute SRMCPs, NSRMCPs, and SecRMCPs from the pricing run will be published to Data Miner for public view. The procedure for finalizing the Real-time MCPs along with LMPs is described in section 2.10 of this manual.

During periods when there is no reserve shortage, prices for Reserves will be determined by the cost of the applicable marginal reserve resource of the product type.

- The cost of the marginal reserve resource is defined as its reserve offer plus any opportunity cost for this resource relative to forgone energy or other ancillary service payments. In the pricing run, the cost of the marginal reserve resource may also include amortized Start-Up and amortized No-Load Costs due to integer relaxation for eligible Fast-Start resources.

Cost of the Marginal Reserve Resource = Reserve Offer + Lost Opportunity Cost + (Amortized Start Up Cost + Amortized No Load Cost)*

*Amortized Start-Up and No-Load Cost may only be included in the pricing run due to integer relaxation for eligible Fast-Start resources.

Resource Opportunity Costs (\$) = LMP – Resource Energy Offer

When there is a Reserve shortage, the maximum Real-time prices are capped as follows:

- Synchronized Reserves capped at two times the penalty factor (\$1,700)
- Non-synchronized Reserves capped at one and a half times the penalty factor (\$1,275)
- Secondary Reserves capped at one times the penalty factor (\$850)

4.4.5.1 Determination of Synchronized Reserve Clearing Prices

During periods when there is no Synchronized Reserve Shortage, the SRMCP is the cost of the Marginal Synchronized Reserve resource. During periods when there is a shortage of

Manual 11 Reserve Price Formation Revisions – Redline

Synchronized Reserves, the SRMCP will be greater than or equal to the penalty factor of the location where the shortage occurred.

The prices for Synchronized Reserve will always be greater than or equal to the Non-Synchronized Reserve Market Clearing Price (NSRMCP) in the same location because Synchronized Reserve is a higher quality product than Non-Synchronized Reserves and may be substituted for it. Similarly, the Real-time prices for Non-Synchronized Reserve will always be greater than or equal to the Secondary Reserve Market Clearing Price (SecRMCP) in the same location because Non-Synchronized Reserve is a higher quality product than Secondary Reserves and may be substituted for it as referenced in section 4.4.1.

The Day-ahead hourly SRMCPs and Real-time five (5) minute SRMCPs from the pricing run are used for market settlement purposes.

Resources that are assigned Synchronized Reserves will be paid the SRMCP corresponding to the location in which they provided the service.

4.4.5.2 Determination of Non-Synchronized Reserve Clearing Prices

During periods when there is no Primary Reserve Shortage, the NSRMCP is the cost of the Marginal Primary Reserve Resource. If the marginal resource is a Synchronized Reserve Resource, the cost of the Marginal Primary Reserve Resource is defined as its Synchronized Reserve Offer plus any opportunity cost for this resource relative to forgone energy or other ancillary service payments.

During periods when there is a shortage of Primary Reserves, the NSRMCP will be greater than or equal to the penalty factor of the location where the shortage occurred.

The NSRMCP will always be less than or equal to the SRMCP in the same location because Synchronized Reserve is a higher quality product than Non-Synchronized Reserve and may be substituted for it.

The Day-ahead hourly NSRMCPs and Real-time five (5) minute NSRMCPs from the pricing run are used for market settlement purposes.

Resources that are assigned Non-Synchronized Reserves will be paid the NSRMCP corresponding to the location in which they provided the service.

4.4.5.3 Determination of Secondary Reserve Clearing Prices

During periods when there is no 30-minute Reserve Shortage, the SecRMCP is the cost of the Marginal 30-minute Reserve Resource. If the marginal resource is an online Reserve Resource, the cost of the Marginal 30-minute Reserve Resource is defined as its Reserve Offer plus any opportunity cost for this resource relative to forgone energy or other ancillary service payments.

Manual 11 Reserve Price Formation Revisions – Redline

During periods when there is a shortage of 30-minute Reserves, the SecRMCP will be equal to the penalty factor of the location where the shortage occurred.

The SecRMCP will always be less than or equal to the SRMCP and NSRMCP in the same location because Synchronized Reserve and Non-Synchronized Reserve are higher quality products than Secondary Reserve and may be substituted for it.

The hourly Day-ahead SecRMCPs and Real-time five (5) minute SecRMCPs from the pricing run are used for market settlement purposes.

Resources that are assigned 30-minute Reserves will be paid the SecRMCP corresponding to the location in which they provided the service.

Section 4.5 Event Performance

During a Reserve Event, PJM may request generation resources, which are assigned in real-time to provide Reserves, to increase their energy output. Any resource that is committed for Synchronized Reserves when a Synchronized Reserve Event occurs is obligated to respond to the PJM's instructions at the start of the event within ten (10) minutes.

Section 4.5.1 Performance Verification

- The magnitude of each resource's response to an event is dependent on the type of event called.
 - For Synchronized Reserve Events:
 - The magnitude of each resource's response is the difference between the resource's output at the start of the event and its output ten (10) minutes after the start of the event.
 - In order to allow for small fluctuations and possible telemetry delays, resource output at the start of the event is defined as the lowest telemetered output between one (1) minute prior to and one (1) minute following the start of the event.
 - Similarly, a resource's output ten (10) minutes after the event is defined as the greatest output achieved between nine (9) and eleven (11) minutes after the start of the event.
 - For Economic Load Response considered "batch load" resources, a second method of verification will be used for instances where a Synchronized Reserve Event is initiated and the resource is operating at the minimum consumption level of its duty cycle. In this case, the magnitude of the response will be measured as the difference between (a) the resource's consumption at the end of the event and (b) the maximum consumption within a ten (10) minute period following the event provided that all subsequent minutes following that minute are no less than 50% of the consumption in that minute.

Manual 11 Reserve Price Formation Revisions – Redline

- For Non-Synchronized Reserve Events: The magnitude of each generation resource’s response is its output ten (10) minutes after the start of the event. A generation resource’s output ten (10) minutes after the event is defined as the greatest output achieved between nine (9) and eleven (11) minutes after the start of the event.
- All resources must maintain an output level greater than or equal to that which was achieved as of ten (10) minutes after the event for the duration of the event or thirty (30) minutes from the start of the event, whichever is shorter.
 - The response actually credited to a given resource will be reduced by the amount the MW output of that resource falls below the level achieved after ten (10) minutes by either the end of the event or after thirty (30) minutes from the start of the event, whichever is shorter.
- In cases where an event lasts less than ten (10) minutes, resources are credited with the amount of reserve capacity they are assigned.
- An offline generation resource assigned to provide Secondary Reserve in real-time that is subsequently dispatched by PJM to provide Energy during that Operating Day is required to come online and reach Economic Minimum output within 30 minutes.
- An Economic Load Response resource assigned to provide Secondary Reserve in real-time that is subsequently dispatched by PJM to provide Energy as a load reduction during that Operating Day is required to reduce load by at least the Economic Minimum within 30 minutes.
 - An Economic Load Response resource’s starting MW usage is the greatest telemetered consumption between one minute prior to and one minute following the dispatch instruction, and the ending MW usage shall be the lowest consumption between 29 and 31 minutes after the dispatch instruction.
 - For Batch Load Economic Load Response Participant Resources, a second method of verification will be used for instances where a Secondary Reserve assignment dispatched as an energy load reduction is initiated and the resource is operating at the minimum consumption level of its duty cycle. In this case, the magnitude of the response will be measured as the difference between (A) the minimum of the resource’s consumption between the minute before and the minute after the end of the last settlement interval the resource reduced load and (B) the maximum consumption within a ten (10) minute period following the end of the last settlement interval the resource reduced load provided that all subsequent minutes following that minute are no less than 50% of the consumption in that minute.

Section 4.5.2 Non-Performance

All resources are credited with a capacity payment any time they are expected to be ready to respond to a Synchronized Reserve Event and failure to provide the directed response results in an obligation to “repay” that credit following instances of non-performance. The following consequences exist for a resource that does not respond with its expected amount of Synchronized Reserve:

Manual 11 Reserve Price Formation Revisions – Redline

- The resource is credited for Synchronized Reserve capacity in the amount that actually responded for all Real-time settlement intervals (five (5) minutes) the resource was assigned or self-scheduled Synchronized Reserve on the day the event occurred, and;
- The owner of the resource incurs a retroactive obligation to refund at the SRMCP the amount of the shortfall measured in MW for all of the Real-time settlement intervals the resource was assigned or self-scheduled over the immediate past interval, the duration of which is equal to the lesser of the average number of days between events as determined by the annual review of the last two (2) years, or the number of days since the resource failed to respond with its assigned or self-scheduled Synchronized Reserve amount in response to a Synchronized Reserve Event.
 - The annual review described above will be completed during the month of November and cover a two (2) year window from November 1st (year – 2) through October 31st (current year). The calculation will be the average interval between Synchronized Reserve Events over the last two years of Synchronized Reserve Event data, rounded down to a whole day value. The results will be communicated to the Operating Committee in December and implemented annually on January 1st.

In cases where a Synchronized Reserve Event lasts less than ten (10) minutes, resources are credited with the amount of Synchronized Reserve capacity they are assigned. The owner of the resource will not incur a retroactive obligation to refund any shortfall between the amount of reserve assigned or self-scheduled and the amount of response provided during the event.

Resources that choose to respond to a Synchronized Reserve Event for their reserve zone in an hour when they are cleared or assigned regulation are expected to return to their regulating band within ten (10) minutes of the end of the Synchronized Reserve Event. From the start of the event, through the event, and for the ten (10) minutes after the end of the event, the performance scores for all regulating resources in the reserve zone where the Synchronized Reserve Event takes place will be null.

In the event a resource that has been assigned to provide Non-Synchronized Reserves fails to provide the assigned amount of Non-Synchronized Reserves in response to a Non-Synchronized Reserve Event, the resource will only be credited for Non-Synchronized Reserve capacity in the amount that actually responded for the continuous five (5) minute intervals the resource was assigned Non-Synchronized Reserves during which the event occurred.

Resources assigned to provide Secondary Reserve in real-time that are subsequently dispatched by PJM to provide Energy during that Operating Day but do not meet their obligation are required to buy back the day-ahead assignment at the Real-time Secondary Reserve Market Clearing Price, or if solely assigned in real-time not being paid for the assigned MW.

- For each generation resource that fails to come online and reach Economic Minimum output within 30 minutes as instructed by PJM the resource's Real-time Secondary Reserve assignment will be set to zero megawatts for that interval and for all prior intervals in which the resource was assigned to provide Secondary Reserve in the Real-time Secondary Reserve Market starting at the later of (A) the last interval the resource

Manual 11 Reserve Price Formation Revisions – Redline

was online or (B) the beginning of that Operating Day and continuing up to the interval the resource failed to come online.

- For each Economic Load Response Participant resource that fails to reduce load by at least the Economic Minimum within 30 minutes as instructed by PJM, the resource's Real-time Secondary Reserve assignment will be set to zero megawatts for that interval, and for all prior intervals in which the resource was assigned to provide Secondary Reserve in the Real-time Secondary Reserve Market between such non-performance event starting at the later of (A) the last interval the resource reduced load at the instruction of the Office of the Interconnection or (B) the beginning of that Operating Day, and for all subsequent intervals through the earlier of (C) the next interval in which the resource is dispatched to reduce load or (D) the end of the Operating Day.

Section 4.6 Reserve Obligations

Each Load Serving Entity (LSE) on the PJM system incurs a Synchronized Reserve Obligation, Non-Synchronized Reserve Obligation, and Secondary Reserve Obligation in kWh based on their Real-time load ratio share and the total MW assigned to meet each applicable requirement.

- Participants can estimate their share of the PJM Synchronized Reserve Requirement, PJM Primary Reserve Requirement, and 30-Minute Reserve Requirement in advance by comparing their hourly load forecast to the PJM hourly load forecasts provided by PJM.
- When the respective Reserve Market Clearing Price (SRMCP, NSRMCP, or SecRMCP) is the same throughout the Reserve Zone or active Reserve Sub-zone, an LSE's respective Reserve Obligation is equal to its obligation load ratio share times the amount of respective Reserve assigned for the Reserve Zone or active Reserve Sub-zone as applicable.
- When congestion causes the respective Reserve Market Clearing Prices (SRMCP, NSRMCP, or SecRMCP) to separate, each LSE's obligation is equal to its obligation load ratio share within the Reserve Zone or active Reserve Sub-zone times the amount of respective Reserve MW assigned in the applicable Reserve Zone or active Reserve Sub-zone.
- Participant may fulfill their respective Reserve Obligations by:
 - Self-scheduling from its own generation resources capable of providing the respective Reserves;
 - Entering bilateral arrangements with other market participants as described in Section 4.7 of this Manual; or
 - Purchasing the applicable Reserves quantity from the market.

Section 4.7 Bilateral Transactions

PJM Settlement shall be the Counterparty to the purchases and sales of Synchronized Reserve, Non-Synchronized Reserves, and Secondary Reserves.

Bilateral Reserve Transactions may be reported to PJM for Synchronized Reserves, Non-Synchronized Reserves and Secondary Reserves. Such reported Bilateral Reserve Transactions

Manual 11 Reserve Price Formation Revisions – Redline

must be for the physical transfer of category of Reserves and must be reported by the buyer and subsequently confirmed by the seller through the Markets Gateway System no later than 1415 the day after the transaction starts. Bilateral transactions that have been reported and confirmed may not be changed; they must be deleted and re-reported. Deletion of a reported bilateral transaction after its start time has passed will result in a change in the end time of the transaction to the current hour.

Bilateral Reserve Transactions reported to PJM may be entered either in MW (minimum MW amount is 0.1 MW). There are separate transaction types based on the product being transferred. Participants are also required to indicate the Reserve Zone or Sub-Zone for which the transaction is applicable.

Payments and related charges associated with the Bilateral Reserve Transactions reported to PJM shall be arranged between the parties to the bilateral contract.

A buyer under a Bilateral Reserve Transaction reported to PJM agrees that it guarantees and indemnifies PJM, PJM Settlements, and the Market Participants for the costs of any purchases by the seller in the Synchronized, Non-Synchronized, or Secondary Reserve Markets, as determined by PJM, to supply the reported bilateral transaction and for which payment is not made to PJM Settlement by the seller.

Upon any default in obligations to PJM or PJM Settlements by a Market Participant, PJM shall not accept any new bilateral reporting by the Market Participant and shall terminate all of the Market Participant's reporting of Markets Gateway schedules associated with its Bilateral Reserve Transactions previously reported to PJM for all days where delivery had not yet occurred.

PJM calculates and posts Synchronized Reserve, Non-Synchronized Reserve, and Secondary Reserve preliminary billing data which Market Participants can use as a resource for pricing Bilateral Reserve Transactions.

The data can be found via PJM's Data Miner 2 Tool:
http://dataminer2.pjm.com/feed/ancillary_services.

http://dataminer2.pjm.com/feed/sync_reserve_prelim_bill/definition.
Add links to additional prelim reports

Section 4.8 Settlements

PJM Reserve settlements are a zero-sum calculation based on the Reserves provided to the market by Market Sellers and purchased from the market by Market Buyers.

Please refer to PJM Manual 28: Operating Agreement Accounting for settlement details.

~~Day-ahead Reserve Settlements~~

A resource that receives a Day-ahead Reserve assignment is paid the hourly Market Clearing Price for the applicable reserve category from the pricing run solution and multiplied by the cleared megawatt quantity of the applicable Reserve from the dispatch run.

Real-Time Reserve Settlements

Integer relaxation for energy in the pricing run may lead to different flexible reserve assignments in the pricing run; however, resources will not be assigned reserves below their economic minimum and commitments from the dispatch run will be used in settlements. In the after-the-fact settlement, any resources cleared as self-scheduled to provide Synchronized Reserves are compensated at the applicable five (5) minute SRMCP. Any pool-scheduled resources selected to provide Synchronized Reserves are compensated at the higher of the applicable five minute SRMCP or their Real-time opportunity cost plus their Synchronized Reserve offer price

Resources providing Regulation at the initiation of a Synchronized Reserve Event will be compensated for Tier 1 response. Tier 1 response is calculated according to the following formula:

$$\left\{ \begin{array}{l} \{100\} \\ \max(0, (Final\ Output - \min(EcoMax, RegHighLimit))) \\ + \\ \max(0, (\min(EcoMax, RegHighLimit, Final\ Output) - Initial\ Output - (2 * RegMW))) \end{array} \right\}$$

Where:

Final Output

is the resource’s greatest telemetered output between nine (9) and eleven (11) minutes after a Synchronized Reserve Event is initiated.

Initial Output

is the resource’s lowest telemetered output between one (1) minute before and one (1) minute after a Synchronized Reserve Event is initiated.

RegMW

is the resource’s assigned amount of Regulation.

As a result of this formula, resources that are assigned Regulation when a Synchronized Reserve Event is initiated will be compensated based on the amount of response provided beyond their regulation commitment, as well as for any response in excess of their regulation high limit or economic maximum (whichever is lower.) A resource’s regulation maximum commitment will be defined as the resource’s full regulating range (i.e. — twice the amount of assigned regulation.)

Please refer to PJM Manual 28: Operating Agreement Accounting, Section 6: Synchronized Reserve Accounting for further details on Tier 1 Synchronized Reserve Credits and Tier 2 Synchronized Reserve Credits.

Section 5: Market Clearing Processes and Tools

5.2.4 Markets Database System

The Markets Database System is a two-part system:

- The Markets Database stores the basic resource data supplied by the PJM Members, including operating limits and resource availability.
- The Markets Gateway Web-site provides the Internet-based user interface that allows Market Participants to submit generation offers, ~~Economic~~ Economic Load Response offers, Demand bids, Increment Offers, Decrement bids, Regulation Offers and Reserve Offers into the Markets Database.

The Markets Database is a very large database that contains information on each generating resource that operates as part of the PJM Energy Market, Economic Load Response information, Demand Information, Virtual Bids, Regulation Offers, Reserve Offers, Day-ahead Energy and Reserve Market Clearing Prices, Regulation Market Clearing Prices and Real-time Reserve Market Clearing Prices. A description of the Markets Database can be found in the Markets Database Dictionary.

PJM clears the real-time Reserve and Regulation markets on an hourly basis. The following is the timeline by which this hourly clearing is accomplished:

- Sixty (60) minutes prior to the operating hour PJM executes the Ancillary Services Optimizer (ASO). The ASO jointly optimizes Energy, Synchronized Reserves, Non-Synchronized Reserves, Secondary Reserves and Regulation based on forecasted system conditions to determine an economic set of inflexible reserve resources to commit for the operating hour.

The data that needs to be submitted by PJM Members to participate in the Day-ahead Energy, Real-time Energy, Reserve and Regulation Markets is described in detail in the Markets Database Dictionary.

Section 10: Overview of the Demand Resource Participation

10.1 Overview of Demand Resource Participation

~~PJM Economic Load Response enables Demand Resources to respond to PJM Energy, Synchronized Reserve, and/or Secondary Reserve prices by reducing consumption and receiving a payment for the reduction or following PJM signal to reduce or increase load if providing regulation services.~~

The integration of Demand Response (DR) into the PJM Markets recognizes the importance of Load Response to a fully functioning market as well as the effect of Load Response on the reliability of the grid. The purpose of these rules is to enable Demand Resources under the direction and control of Curtailment Service Providers (CSPs) to participate in the various PJM markets. CSPs are Members or Special Members of PJM that participate in the PJM Markets by causing Demand Resources to reduce demand.

Manual 11 Reserve Price Formation Revisions – Redline

PJM Emergency or Pre-Emergency Load Response enables Demand Resources that reduce load during emergency or pre-emergency conditions to receive payment for those reductions.

- Demand Resources in the Energy Only Option of Emergency Load Response are defined as Demand Resources that receive only an energy payment for reductions.
- Demand Resources in Full Emergency or Pre-Emergency Load Response are defined as Demand Resources that receive both an energy payment for reductions and a capacity payment.
- Demand Resources in Capacity Only Option of Emergency or Pre-Emergency Load Response are defined as Demand Resources that receive only a capacity payment for reduction.

PJM Economic Load Response enables Demand Resources to respond to PJM Energy, Synchronized Reserve, and/or ~~Day-ahead Scheduling~~ Secondary Reserve prices by reducing consumption and receiving a payment for the reduction or following PJM signal to reduce or increase load if providing regulation services.

- The Day-ahead Option provides a mechanism by which any qualified Market Participant may offer Demand Resources the opportunity to reduce the load they draw from the PJM system in advance of Real-time operations and receive payments based on Day-ahead LMP for the reductions.
- The Real-time Option provides a mechanism by which any qualified Market Participant may offer Demand Resources the opportunity to commit to a reduction and receive payments based on Real-time LMP for the reductions.

Energy Settlements shall be limited to demand reductions that are executed in response to the Real-time and/or Day-ahead LMP or as dispatched by PJM and that are not implemented as part of normal operations. Reductions that do not meet these requirements are not eligible for settlement. Examples of ineligible settlements include, but are not limited to the following:

- Settlements based on variable demand where the timing of the demand reduction supporting the settlement did not change in direct response to the Real-time and/or Day-ahead LMP.
- Consecutive daily settlements that are the result of a change in normal demand patterns that are submitted to maintain a Customer Baseline Load (“CBL”) that no longer reflects the relevant end-use customer’s demand.
- Settlements based on On-Site Generator data if the On-Site Generation is not supporting demand reductions executed in response to the Real-time and/or Day-ahead LMP.

- Settlements based on demand reductions that are the result of operational changes between multiple end-use customer sites in the PJM footprint except that settlements based on such demand reduction shall be allowed if the demand reduction alleviates congestion.
- Settlements based on load reductions from normal operations that would have occurred without PJM dispatch, or that would have occurred absent PJM energy market compensation as approved under Order 745.

PJM shall disallow settlements for demand reductions that do not meet the requirements set forth above. If the CSP continues to submit settlements for demand reductions that do not meet the requirements set forth above then PJM shall suspend the CSP’s Energy Market activity and refer the matter to the FERC Office of Enforcement.

10.2 Demand Resource Registration Requirements

CSPs shall register Demand Resources that choose to participate in the PJM Energy, Capacity, Synchronized Reserve, Secondary Reserve or Regulation Market according to the rules and requirements set forth below. A CSP is required to have effective agreement with a customer to register a location.

10.2.1 Registration Combinations

One or more CSPs may register the same location (EDC account number) to one or more registrations based on the following conditions:

| Scenario | Economic (Energy, SR, DASR , Reg) | Economic (Energy Only) | Economic Regulation Only | Emergency or Pre-Emergency Capacity Only | Emergency or Pre-Emergency Full (Capacity and Energy) | Emergency Energy Only |
|----------|--|------------------------|--------------------------|--|---|-----------------------|
| CSP1 | Yes | No | No | No | Yes | No |
| CSP1 | Yes | No | No | Yes | No | Yes |
| CSP1 | Yes | No | No | No | No | Yes |
| CSP2 | No | No | No | Yes | No | No |
| CSP1 | No | No | Yes | No | No | No |
| CSP2 | No | Yes | No | No | Yes | No |
| CSP1 | No | Yes | Yes | No | No | Yes |
| CSP2 | No | No | No | Yes | No | No |
| CSP1 | No | No | Yes | No | No | No |
| CSP2 | No | Yes | No | No | No | Yes |
| CSP3 | No | No | No | Yes | No | No |

TABLE

Economic (Energy, SR, ~~DASRSECR~~, Reg) – a registration that allows participation in the energy market and ancillary service market(s) if certified and approved by PJM.

Economic (Energy Only) – an economic registration that only allows participation in the Energy market. This is normally used when one economic CSP has an Economic Regulation Only registration and the second economic CSP has the Economic (Energy Only) registration.

Economic Regulation Only – a registration that only allows participation in the Regulation market.

Emergency Capacity Only – a registration that only allows participation in the Capacity market as an RPM or FRR capacity resource. If the registration is dispatched for emergency conditions the resource does not receive an energy payment. Only resources that rely on On-Site Generation to fulfill its load reduction obligations and have environmental restrictions as defined and required by applicable local, state or federal law, ordinances and regulations, on when it can operate such that it is only permitted to operate if PJM is in emergency conditions may register as an Emergency Capacity Only resource.

Pre-Emergency Capacity Only – a registration that only allows participation in the Capacity market as an RPM or FRR capacity resource. If the registration is dispatched for PreEmergency conditions the resource does not receive an energy payment.

Emergency Full (Capacity and Energy) – same as Emergency Capacity Only registration but receives emergency energy compensation when dispatched for emergency conditions. Only resources that rely on On-Site Generation to fulfill its load reduction obligations and have environmental restrictions on when it can operate such that it is only permitted to operate if PJM is in emergency conditions may register as an Emergency Full resource.

Pre-Emergency Full (Capacity and Energy) – same as Pre-Emergency Capacity Only registration but receives emergency energy compensation when dispatched for Pre-Emergency or emergency conditions. Locations that register with one CSP for Emergency Full or Pre-Emergency Full can register with a second CSP only for Economic Regulation-Only.

Locations that register with one CSP for Emergency Capacity Only or Pre-Emergency Capacity Only can register with a second CSP for:

- Economic (Energy, SR, ~~DASRSECR~~, Reg) or;
- Economic (Energy Only) and/or;
- Economic Regulation Only.

Locations that register with one CSP for Emergency Capacity Only or Pre-Emergency Capacity Only, and with a second CSP for Economic Regulation Only, can also register with a third CSP for Economic (Energy Only).

A single location may only register as either a Pre-Emergency or an Emergency resource for the Delivery Year.

10.2.2 Curtailment Service Providers

The following business rules apply to CSPs:

- Prior to participating in the PJM Markets, CSPs must complete a registration in the appropriate PJM Tool which identifies the specific location(s) based on the unique EDC account number that will participate and their associated load reduction capability. CSPs shall maintain the accuracy of the registration information provided to PJM for each demand resource and each time the CSP registers the location or extends the registration, the CSP will review all information to ensure it is reasonably accurate and update as necessary. On a periodic basis, PJM may request supporting information from the CSP to verify that the information provided by the CSP is reasonably accurate.
- In order to register demand resources all specific information as defined in the DR Hub User Guide shall be provided including the following:
 - Business Segment - CSPs shall classify locations according to the location's primary purpose or business use. CSPs should first determine if the location's business use falls under one of the following primary categories: Hospitals, Industrial / Manufacturing, Multiple Dwelling Unit, Office Building, Residential, Retail Service, Correctional Facilities or Schools. In cases where the location does not fit into one of the primary categories the CSP shall select from one of the following categories: Agriculture, Forestry and Fishing, Mining, Transportation, Communications, Electric, Gas and Sanitary Services or Services. A description of each category is included in the DR Hub user guide.
 - Max Load – CSPs best estimate of annual peak load.
 - Load Reduction Method and associated Capability - The CSPs shall provide for each location the load reduction method and the associated load reduction kilowatt capability. Load reduction methods indicate the type of electrical equipment that is controlled to provide the demand response activity and include: Heating, Ventilation and Air Conditioning (HVAC), Lighting, Refrigeration, Manufacturing, Water Heaters, Batteries, Plug Load and Generation.
 - A Plug Load represents an electronic device that is plugged into a socket, which is not already represented by the methods described above. Examples of Plug Load include IT Peripherals, such as large computers, monitors, printers, routers, copiers and scanners or appliances such as washers, dryers or dishwashers.

Manual 11 Reserve Price Formation Revisions – Redline

- The CSP shall provide the load reduction kilowatt capability for each method which represents a reasonable estimate of the location’s expected hourly energy load reduction (at the retail meter) that will be performed during a system emergency when wholesale energy prices are high and the resource participates in the wholesale market. The load reduction kilowatt capability may be significantly different than the capacity commitment or the economic energy offered into the wholesale market on a daily basis. The load reduction capability should not reflect the entire load for the location unless the location expects to reduce all load during a PJM emergency when participating in the wholesale capacity and/or energy market. If Generation will be used to reduce all of the load at the location and the location will reduce load with other load reduction methods then the Generation load reduction capability should reflect the expected load after the other load reduction methods have been deployed. This allows the sum of each load reduction method capability (Max Output) to reflect the total load reduction capability for the location.
- The CSP shall report the following generation attributes for each generation unit at the location. Only locations with On-Site Generation that are used to provide the load reduction and have environmental restrictions as defined and required by applicable local, state or federal law, ordinances and regulations that require emergency conditions to operate may qualify as an Emergency Demand Resource. Multiple generators may be listed.
 - Non-Retail BTMG – CSPs shall indicate if the generator is used to serve multiple retail electricity customers with use of a distribution system. This would typically be located in a municipal electric system or electric cooperative.
 - Max Output – CSPs shall provide PJM with the kW output that the generator will use for PJM Demand Response load reduction.
 - Backup Generator Only – CSPs shall indicate if the generator is used exclusively to maintain electricity during an unexpected or unplanned disconnection from the grid or for PJM Demand Response load reduction. CSPs should select “No”, if a generator typically operates to reduce load (peak shaving, combined heat and power/cogen, etc.).
 - On-Site Generator Type - CSPs shall provide PJM with the type of On-Site Generation used for load reduction. On-Site Generator types are: Internal Combustion Engine, Combustion Turbines, Steam Engines and Cogeneration units (this also includes Central Heat and Power units).
 - Generator Fuel Type - Locations that use generators, in whole or in part as a load reduction method, shall provide PJM with the primary fuel type used for each generator which includes: Coal, Diesel, Natural Gas, Oil, Gasoline, Kerosene, Propane, Wood, Landfill Gases and Waste products.

Manual 11 Reserve Price Formation Revisions – Redline

In cases where the On-Site Generator has a mixed fuel type, CSPs should report on the primary fuel source as the On-Site Generator fuel type.

- Generator Vintage - The year the generator was built (included on nameplate). If the exact year is unknown, the CSPs should use a reasonable estimate.
- Generator Retrofit Year - If the generator was retrofitted for pollution control equipment please include the year of the retrofit or a reasonable estimate of the year if the specific year is not available.
- Nameplate Capacity - MW rated capacity for the generator.
- Permit Status - The current status of environmental permits for the generator where:
 - "Available" - indicates that the CSP represents to PJM that the end-use customer generator has all the Local, State and Federal permits required to operate in the PJM Market as a demand response resource. Unless notified otherwise, the Office of the Interconnection shall deem such representation applies to each time the On-Site Generator is used to reduce demand to participate in the PJM markets and that the On-Site Generator is being operated consistent with all applicable permits.
 - "Permit Application in Progress" - indicates that the CSP represents to PJM that one or more of the required Local, State and/or Federal permits for the end-use customer generator are pending and are expected to be received prior to the effective date of registration. The CSP will terminate the registration, if the On-Site Generator is the only source for the demand response activity, and update the status if necessary permits are not received prior to such end-use customer generator's registration effective date.
 - "Not Applicable" – indicates that the CSP represents to PJM that one or more of the Local, State and/or Federal permits for the end-use customer generator are not required for the generator to participate as a Demand Resource and all other necessary permission from appropriate Local, State and Federal environmental agencies has been received.
- Permit Type – The permit type indicates whether On-Site Generators can run during emergency or non-emergency conditions:
 - “Emergency Only” – An “Emergency Only” permit type indicates that the On-Site Generator has the Local, State and Federal permits required to operate in the PJM Market as a demand response resource during grid emergency conditions. This also indicates that such locations may qualify as an Emergency resource instead of being a Pre-Emergency resource.

Manual 11 Reserve Price Formation Revisions – Redline

- “Non-Emergency” - A “Non-Emergency” permit type indicates that the On-Site Generator has the Local, State and Federal permits required to operate in the PJM Market as a demand response resource during emergency and non-emergency grid conditions.
- Interconnection Type – The CSP will indicate if the generator is interconnected to allow injections onto the transmission and distribution system. The CSP will designate as: “none”, “ISA”, “WMPA”, “NEM”, “PURPA QF” or other category as necessary. If ISA, WMPA, or PURPA QF then the CSP will also provide the appropriate PJM reference to the generator and the associated amount of injection rights.
- The CSP shall report the following battery attributes used as an On-Site Generator at the location
 - Max Output – CSPs shall provide PJM with the kilowatt output that the battery will use for PJM Demand Response load reduction.
 - Battery Capacity (kW 1C) – CSPs shall provide PJM with the maximum kilowatt discharge capability in one hour.
 - Vintage – CSPs shall provide PJM with the year the battery was manufactured.
 - Chemistry – CSPs shall indicate the type of battery technology. Chemistry types are: Lithium-Ion, Lithium-Air, Lithium-Metal, Lithium-Sulfur, Lead Acid, Zinc-Ion, Sodium-Ion, Sodium-Metal Halide, Magnesium-Ion, Magnesium-Lithium Hybrid, ZincManganese Oxide, Vanadium-Redox Flow, Zinc-Polyiodide Flow and, Organic Aqueous Flow.
 - Type – CSPs shall indicate the installation setup for the battery. Types are: Electric Vehicle, PV system and, Stand alone.
- Economic registrations must have the same EDC, LSE, Transmission zone and Pricing point where each location is defined as a unique EDC account number and may be included on the registration subject to aggregation rules in this Manual. Emergency registrations, Economic Regulation Only registrations, and Economic registrations for Residential customers that do not participate in the Day-ahead Market must have the same EDC and Transmission zone.
- If the CSP has an Economic Regulation Only registration then the Economic registration will only allow same location(s) to participate in the Energy Market (“Economic (Energy Only)” in chart above) and they will not be permitted to participate in the SR or ~~DASR~~ SECR market.
- If the CSP has an Economic registration with any certified Ancillary Service (SR, ~~DASR~~ SECR or Reg) then the Economic Regulation Only registration may not be submitted.

Manual 11 Reserve Price Formation Revisions – Redline

- Economic Regulation Only CSPs must be able to manage regulation for the location whether or not the location has been called to provide capacity during an emergency or pre-emergency situation or is providing a load reduction as an economic resource in the energy market.
- Demand Resources may be registered simultaneously as Economic Load Response Resources and Emergency or Pre-Emergency Load Response Resources.
- Demand Resources may switch CSPs. The CSP registering the switching Demand Resource shall provide PJM with the registration information of the resource. Registrations may only be submitted when there is an effective contract with the customer for the term and product on the registration. CSPs shall check their records to ensure they have an effective contract to support the registration and contact the customer as appropriate before they submit the registration. PJM treats the switching as a new registration. If the current registration is a full Emergency or full Pre-Emergency registration and the Delivery Year has begun, the new registration is denied. Both new and current CSPs are notified by PJM of the switch and are given 5 business days to affirm they have a valid contract with the end-use customer for the term and product as included on their registration and notify PJM through the appropriate system that the customer has affirmed the contract. After 5 business days, if only one CSP has affirmed their registration in the appropriate PJM system, that CSP's registration continues and the other registration is terminated as soon as possible. If both CSPs have affirmed their registration, both registrations are terminated as soon as possible. In order to accommodate Day-ahead Load Response the switch or termination becomes effective at 0001 of the third business day after the previous registration is terminated or deemed terminated by PJM. The previous registration will remain active for the sole purpose of settlement of load reductions that occurred before the switch became effective.
- Demand Resources intending to run an On-Site Generator in support of local load represents to PJM that it holds all applicable environmental and use permits for running those generators by submitting a registration. Continuing participation is deemed as a continuing representation by the owner that each time its On-Site Generator is run it complies with all applicable permits, including any emissions, run-time limit or other constraint on plant operations that may be imposed by such permits.
- ~~Demand Resources intending to run an On-Site Generator in support of local load represents to PJM that it holds all applicable environmental and use permits for running those generators by submitting a registration. Continuing participation is deemed as a continuing representation by the owner that each time its On-Site Generator is run it complies with all applicable permits, including any emissions, run-time limit or other constraint on plant operations that may be imposed by such permits.~~
- CSPs with an On-Site Generator with interconnection rights to participate in the wholesale markets with injections onto the grid through an ISA or WMPA shall:

Manual 11 Reserve Price Formation Revisions – Redline

- Inform PJM that the On-Site Generator will participate as DR to offset load through existing DR market rules and participate as a generation resource with injections as defined by generation market rules.
- Install and maintain telemetry at the point of interconnection and the On-Site Generator, as outlined in PJM Manual 14D: Generator Operational Requirements.
- Request CBL review if the generator will participate as an Economic DR resource in the energy market. This is to ensure the load reductions from the On-Site Generator can be quantified separately from generator injections onto the grid. Load reductions done in order to inject power onto the grid are considered part of normal operations and therefore not eligible for Economic DR settlements.
- Manage the DR offers to reduce load and/or Generation offers to inject power in the wholesale markets based on the actual generator capability. CSPs will make sure that the total offer amount for the modelled resources will not exceed the capability for the generator. All regulation offers will be made through the DR modelled resource or as otherwise approved by PJM.
- A CSP shall not submit a request to be an Emergency resource (instead of Pre-Emergency) unless it has done its due diligence to confirm that the Demand Resource meets the requirements and has obtained from the end-use customer documentation supporting the exception request. The CSP shall provide the Office of the Interconnection with a copy of such supporting documentation within three (3) business days of a request ~~therefor~~. Failure to provide such supporting documentation by the deadline shall result in the Demand Resource being classified as a Pre-Emergency resource.
- Emergency and Pre-Emergency resource offer price may not exceed the following:
 - 30 minute lead time: \$1,000/MWh, plus the applicable Primary Reserve Penalty Factor from the first step of the demand curve, minus \$1.00.
 - Approved 60 minute lead time: \$1,000/MWh, plus the applicable Primary Reserve Penalty Factor from the first step of the demand curve divided by 2.
 - Approved 120 minute lead time: \$1,100/MWh.
 - Please refer to Section 2.8 of this Manual for the business rules regarding when Emergency or Pre-Emergency resources are eligible to set LMP.

10.4.1 Metered Data

Demand Resources must be equipped with interval meters recording electrical usage at the EDC account level. The interval of data collection must be sufficient to provide PJM with hourly, one

minute or real time load data as applicable for the wholesale market. Residential Direct Load Control (RDLC) aggregates may have interval meters installed on a statistical sample of EDC accounts per PJM Manual 19: Load Forecasting and Analysis, Attachment C and subject to PJM approval.

~~Any CSP submitting a settlement for a load reduction made in the Energy Market that is not metered directly by PJM, CSPs are responsible for uploading/forwarding the appropriate meter data (as defined in this Manual) into PJM's DR Hub system -within sixty (60) days of the reduction. Participants submitting a settlement for an energy payment when load reduction complies with a synchronized reserve event or regulation assignment must use data provided by the load meter. This data shall be forwarded through the appropriate PJM system.~~

If the meter data files are not received within sixty (60) days, no payment for participation is provided.

Load data must be provided for all hours of the day and for all days necessary for PJM to calculate the CBL for settlements or to measure compliance as necessary.

When On-Site Generation is used solely to enable the Participant to provide demand reductions then the CSP may provide qualified meter generation output data, upon approval by PJM, from the On-Site Generator for each hour of the event day instead of actual load metered data. Provision of hourly meter data from the On-Site Generator is deemed a certification by the CSP that the On-Site Generator was not used for any purpose other than to support the load reduction during the event day. If the On-Site Generator is used on a regular basis for normal operations then the CSP may provide qualified meter data from the On-Site Generator for each hour of the event provided the amount of generation run to provide Economic Load Response can be quantified in a manner that is acceptable to PJM. For example, if a five (5) MW On-Site Generator that normally provides three (3) MW boosts its output to five (5) MW in response to LMPs the CSP is eligible to receive a demand response energy settlement for the additional two (2) MW of output.

Meter data is forwarded to the EDC upon receipt, and these parties have ten (10) business days to review accuracy and provide feedback to PJM.

Objection by the EDC to the Meter Data shall be clearly set forth in the Comments related to the Settlement Data. The CSP shall correct and re-submit the Settlement Data within two (2) business days. The objecting EDC shall have five (5) business days to review the re-submitted Settlement Data or PJM assumes acceptance.

All load reduction data is subject to PJM Market Monitoring Unit audit.

10.5 Aggregation for Economic, Pre-Emergency and Emergency Demand Resources

The purpose for aggregation is to allow the participation of end-use customers in the Energy Market that can provide less than 100 kW of DR when they currently have no alternative opportunity to participate on an individual basis or can provide less than 100 kw of DR in the

~~Day-ahead Scheduling Reserve (DASR)~~ Secondary Reserve (SECR)), Synchronized Reserve (SR) or Regulation (REG) markets when they currently have no alternative opportunity to participate on an individual basis. An aggregation shall meet the following requirements:

- If the aggregation only provides energy to the market then only one end use customer within the aggregation shall have the ability to reduce more than 99 kW of load unless the CSP, LSE and PJM approve. If the aggregation provides SECR, DASR or SR, or REG to the market then only one end use customer within the aggregation shall have the ability to reduce more than 99kW of load unless the CSP, LSE and PJM approve. If the aggregation provides Regulation Only through and Economic Regulation Only Registration to the market then only one end use customer within the aggregation shall have the ability to reduce more than 99 kW of load unless the CSP and PJM approve.
- All end-use customers in an Economic Registration shall be served by the same EDC LSE and have the same energy pricing point. All end-use customers in an Emergency and Pre-Emergency Registration, Economic Registration of residential customers not participating in the Day-ahead Market, and Economic Regulation Only Registration shall be served by the same EDC and located in the same Transmission Zone. If the aggregation provides SR, all customers in the aggregation must also be part of the same Synchronized Reserve sub-zone.
- All end-use customers in an aggregation and on the same registration shall be located in the same Transmission Zone, existing load Aggregate, or at the same node except for an Economic Regulation Only Registration. All end-use customers in an aggregation and on the same Economic Regulation Only Registration shall be located in the same Transmission Zone.
- Each end-use customer site must meet the requirements for market participation by a Demand Resource except for the 100 kW minimum load reduction requirement for Energy and Ancillary Services.
- An end-use customer's participation in the Energy and Ancillary Service Markets shall be administered either under one Economic Registration or if only providing Regulation service then with an Economic Regulation Only Registration and an Economic (Energy Only Registration) as outlined in this Manual.